

ROLLWAY®



Bearings - Metric

A Regal Brand

REGAL



BEARING TYPES

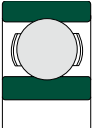

Deep Groove Ball Bearings

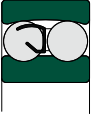

Self-Aligning Ball Bearings

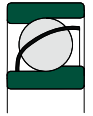

Angular Contact Ball Bearings

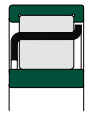

Cylindrical Roller Bearings

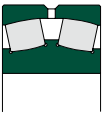

Spherical Roller Bearing

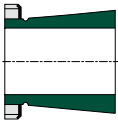

Adapter Sleeves

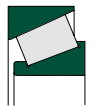

Tapered Roller Bearing

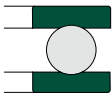

Thrust Ball Bearing



Spherical Roller Thrust Bearings

CONTENTS

PART 1	Page
1) Bearing types and application	4
- Selection	12
- Life & load ratings	16
- Speed	42
- Bearing materials	44
- Suffixes & prefixes	46
2) Lubrication	48
- Handling of bearings	53
3) Fits and clearances	57
- Single row deep groove ball bearings	60
- Single row angular contact bearings.....	62
- Double row self-aligning ball bearings.....	63
- Single & double row cylindrical roller bearings.....	64
- Double row spherical roller bearings.....	66
- Double & four row tapered roller bearings.....	69
4) Shaft & housing tolerances	70
- ISO IT tolerance range	79
- Tolerance symbols.....	80
- Radial bearings	82
- Tapered roller bearings	86
- Double row cylindrical roller bearings	92
- Thrust bearings	94
- Limit dimensions of chamfer	98
- Snap ring and groove tolerances	101
- Abutment recommendations	102

PART 2

- Single row deep groove bearings	109
- Self aligning ball bearings	137
- Single & double row angular contact bearings.....	145
- Single & double & four row cylindrical roller bearings	151
- Spherical roller bearings	215
- Adapter sleeves	233
- Tapered roller bearings	257
- Thrust ball bearings	271
- Spherical roller & tapered roller thrust bearings	281

Characteristics of bearing types and application

Deep Groove Ball Bearings

Deep groove ball bearings are non-separable, comparatively rigid radial bearings, their balls are guided in deep radial running grooves. They are characterized by a high radial and axial load carrying capacity and can operate at very high speed.

Combined loads are accommodated to an optimum degree - in fact, at higher speeds they are often better suited to transmit thrust loads than the ball thrust bearing. For these reasons and their economical price, it is the most widely used bearing.

Deep groove ball bearings are also available with one or two non-rubbing metal shields (Z, ZZ) or rubbing seals (RS, 2RS) made from synthetic rubber. Bearings with two shields or two seals are pre-lubricated with the correct quantity of grease of a lithium base which permits operating temperatures of $-30^{\circ}\text{C} + 120^{\circ}\text{C}$ ($-22^{\circ}\text{F} + 248^{\circ}\text{F}$).

Deep groove ball bearings with snap ring groove (N) and snap ring (R) in the outer ring enables a simple and space-saving axial location in the housing.

Angular Misalignment

The following is an approximate guide to the misalignment that can be accommodated in the use of a single row ball bearing:

0.0010 radians

A greater degree of misalignment can sometimes be accommodated if pure radial load is applied, particularly if the misalignment results from occasional peak load, and if the bearing had sufficient radial internal clearance after mounting to avoid excessive stresses.

Angular Contact Ball Bearing

There are single-row and double-row angular contact bearings and also duplex (four point contact bearing). Single-row angular contact ball bearings are non-separable and the standard types feature a contact angle of 40° . They are suitable for the accommodation of combined (radial and axial) loads. Axial loads may be transmitted in the direction of the closed face or high shoulder only.

Optimum load transmission starts with $F_a \geq F_r$. Radial forces induce internal axial forces which are absorbed by the opposed bearing. Such bearings should therefore be mounted in pairs, and should be adjusted against another bearing. In the case of length variations of the shaft caused by changes in temperature, which also affects the internal clearance, the distance between the bearings should be kept small.

The maximum permissible speed is somewhat lower than that of deep groove ball bearings. A slight angular deflection is still possible with the single bearing; if bearings are mounted in pairs, however, rigidity greatly increases together with the ability to prevent misalignment.

Single-row angular contact bearings can also be supplied with side faces ground for mounting side-by-side. Suffixes Df, DB, and DT are being used in the bearing designation, ie 7250 BG. They can be mounted in any of three combinations depending on the loading characteristics:

- A back-to-back arrangement (closed face together, load line of the bearings diverging towards the shaft axis) is used where rigidity and an ability to absorb fitting moment is required.

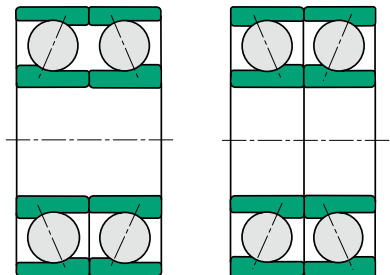

Back-to-Back DB

Face to Face DF

- A face-to-face arrangement (open faces together, load line of the bearings converging on shaft axis) is used where axial loads acting in both directions are to be catered for by one bearing in one direction.

Rigidity is better in the back-to-back arrangement. In the face-to-face arrangement, there is less ability to absorb fitting moments.

- A tandem arrangement (open face-to-closed-face load lines being parallel to each other) is used for thrust loads equally distributed over all bearings, absorbed in one direction only. Adjustment against another bearing which accommodates the opposed thrust load is necessary.

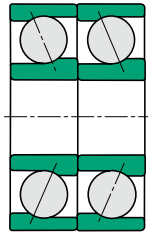

Tandem DT

Double Row Angular Contact Bearings

The inner and outer ring of these bearings each have a double raceway, and the two rows of balls have contact angles that are similar to a back-to-back arrangement. Thrust loads can be accommodated in either directions as well as fitting moments.

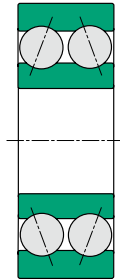

Double Row

Four Point (Duplex)

The 'four-point' contact bearings, or duplex bearings, are in principle angular contact bearings that accommodate axial loading in both directions. They usually have more axial movement than a pair of angular contact bearings correctly adjusted endwise; they are also able to carry combined radial and axial loading, providing the axial load exceeds the radial load at all times. Duplex bearings should not run unloaded, particularly at high speeds, for in this condition the balls contact the raceways at three or four points instead of two points necessary to correct running. Three or four point contact results in over-heating due to the balls skidding. When duplex bearings are required to carry axial loads only, then the outer rings must have radial clearance in the housing.

Angular Misalignment

The following is an approximate guide to the misalignment that can be prevalent when fitting angular contact bearings:

0.0003 radians

Greater misalignment, particularly under pure axial load, can become critical.

Double Row Self-Aligning Ball Bearings

This design of bearing utilizes two rows of balls, with the inner ring having two deep groove raceways and the outer ring a single continuous spherical raceway. This permits the inner and outer ring to be misaligned relative to each other through a comparatively large angle without imposing moment loads upon the balls. This bearing is frequently used when the inner ring is to be mounted upon an adapter sleeve or when conditions in the machine make it difficult to assure accurate alignment of the inner and outer rings.

Due to the small contact angle, the thrust capacity of these bearings is limited.

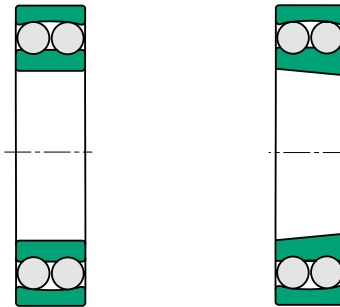

Cylindrical Bore

Tapered Bore 1:12

Angular Misalignment

The following is an approximate guide to the misalignment that can be accommodated in a double row self-aligning ball bearing:

0.04 radians between 2.5 and 3 degrees depending on which series is used.

Bearing series	Permissible Angular Misalignment Degrees
1200 – 1222	2.5
1302 – 1318	3
2200 – 2222	2.5
2300 – 2318	3

Cylindrical Roller Bearings

The rollers of these bearings are essentially cylindrical in shape, providing modified line contact with the cylindrical inner and outer ring raceways. The rollers are accurately guided by ground ribs on either the inner ring or the outer ring, thus making these bearings suitable for heavy radial loads and high speed operation. For best results, these bearings should be accurately aligned.

The cylindrical shape of the rollers allows the inner ring to have considerable axial movement relative to the outer ring. This feature is valuable in accommodating thermal expansion in applications where both the inner ring and outer ring must be press-fitted. Also, since the inner and outer rings are separable from each other, the assembly of equipment is frequently facilitated.

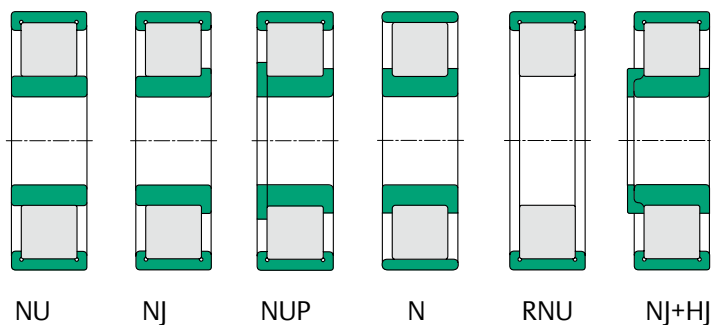

Angular Misalignment

the following is an approximate guide to the misalignment that can be accommodated in a cylindrical roller bearing:

0.0004 radians

Greater misalignment under heavy radial load can be critical.

Tapered Roller Bearings

This design utilizes conical rollers and raceways arranged so that all elements of the roller and raceway cones meet at a common apex on the axis of rotation. The rollers are guided by contact between the large end of the roller and a rib on the high capacity for radial loads and single direction thrust loads.

The bearings are usually mounted in pairs with axial adjustment to provide proper running clearance within the bearings. Being separable, inner and outer rings may be mounted individually.

For heavy thrust loads, the type 30300 with large contact angle is desirable. Tapered roller bearings with two and four rows of rollers are used for special applications.

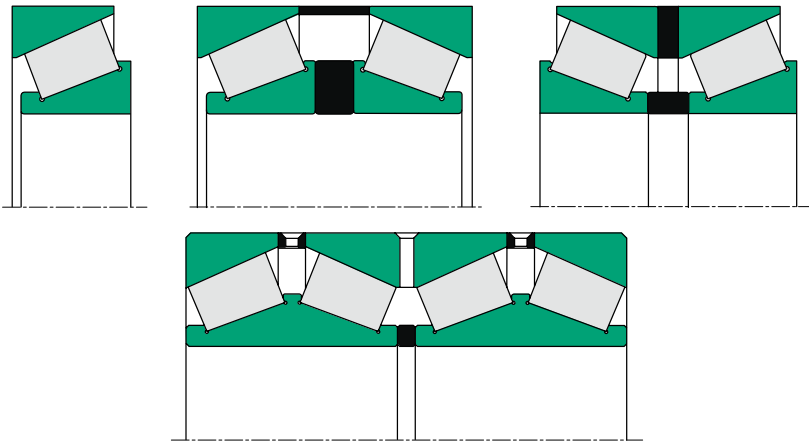

Angular Alignment

The following is an approximate guide to the misalignment that can be prevalent when fitting tapered roller bearings:

2 mins of arc

This is under normal loading conditions.

Spherical Roller Bearings

In this design, two rows of rollers operate in separate raceways ground into the inner ring with guide rib to guide the rollers. The outer ring has a single spherical raceway, thus allowing the inner ring and rollers to freely compensate for angular errors due to inaccurate machine components or due to elastic deflection of the shaft or housing under load.

As a result of the line contact, a large number of rollers, and the substantial contact angle, these bearings have large radial and thrust load capacity. They are suitable for heavy shock and impact loads and thus are extensively used in steel mills, rock crushers, and heavy industrial equipment.

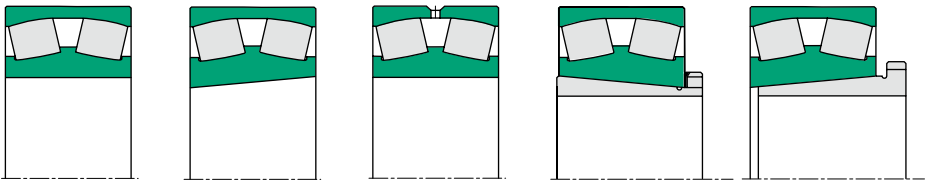

Cylindrical bore

Tapered bore
K 1: 1:12
K30: 1:30

Lubrication groove and holes W33

Adapter sleeve H

Withdrawal sleeve AH

Angular Misalignment

The following is an approximate guide to the misalignment that can be accommodated in a spherical roller bearing-between 1 and 2,5 degrees depending on which series is being used:

Bearing series	Permissible angular misalignment degrees
213	1
222	1.5
223	2
230	1.5
231	1.5
232	2.5
240	2
241	2.5

Thrust Ball Bearings

Thrust ball bearings are separable bearings. The single-acting thrust ball bearing consists of shaft washer, housing washer and ball set with cage, the double-acting type of a shaft washer (centre washer), two housing washer and two ball sets with cages.

Thrust ball bearings can be applied for high axial loads and low to medium speeds, they cannot, however, take radial loads. They are sensitive to angular deflection and characterized by extremely rigid guidance in axial direction.

Depending on speed a minimum load is necessary to avoid sliding movements of the ball set, which are caused by centrifugal forces. To compensate for misalignments of the shaft, bearings with spherical housing washers and support washers should be used.

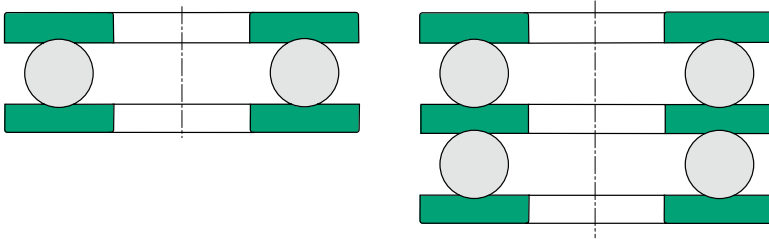

BEARING SELECTION

The following procedure gives the steps to be followed when bearings are selected from the information contained in this catalog. It will be found satisfactory for most applications.

1. Determine the speed of the bearing.
Calculate the loads on the bearings.
2. Establish if accurate alignment can be obtained between the bearing seatings. If it cannot, then bearings that accommodate misalignment should be selected.
3. If the bearings rotate under load decide the life required, calculate the required dynamic load rating 'C' values, and then select suitable bearings that have comparable 'C' values.
If the bearings do not rotate under load selected them by using the static load rating ' C_0 '.
4. Check if the bearings are suitable for the speed and decide of grease or oil is to be the lubricant.
5. Select a suitable bearing arrangement of this is not already known; make sure that the seating fits required can be used with this arrangement.
6. Decide if bearings to 'Standard' or 'Extra Precision' limits of accuracy are required.
Select the most suitable range of radial clearance.
Choose the abutment diameters.
Choose suitable closures.
Issue mounting and handling instructions for the bearings if necessary.

Selecting Of Bearing Type

Each type of bearing has different properties, making it suitable for certain applications. The factors to be considered when choosing a bearing are numerous, so guidance is given to the main points when selecting a bearing. It must also be remembered that special consideration must be given to aspects relating to the running and operating, and to aspects relating to cases where at least one of the principal dimensions of the bearing has been determined by the machine design or shaft size.

Load And Direction Of Load

The magnitude and direction of the external loads, along with built in factors of safety, are two of the main points which determine the bearing size - and in some instances - the bearing type to be used. The important factors are the speed of rotation, temperature, the amount of precision required, mounting conditions, and running noise.

The following illustrations indicate the magnitude and direction of the external loads which the bearings will provide for.

Radial Loads

For light and medium radial loads, ball bearings are generally used; whereas for heavy loads and large shaft diameters, roller bearings are often the only choice.

Cylindrical roller bearings are available in several types. Types NU (with outer ring ribs), and N (with inner ring ribs) are only suitable for radial loads, whereas the NUP, NJ, and NJ with angle ring HJ can be used to a certain extent to take combined loads.

Thrust Loads

Thrust ball bearings are only suitable for light or medium purely axial loads. Double-acting thrust ball bearings can carry thrust loads in either direction. Spherical roller thrust bearings are used where heavy thrust loads are to be absorbed, and in addition can carry a certain amount of radial load acting simultaneously.

Combined Loads

If a radial and thrust load act on a bearing simultaneously, this is termed as a 'Combined Load'. The most important feature affecting the ability of carry axial loads is the angle of contact in relation to the shaft axis. The greater the angle, the more suitable the bearing is to accommodate axial loading. Combined loads are carried by deep groove ball bearings, self-aligning ball bearings, four point bearings, single and double row angular contact bearings, spherical roller bearings, cylindrical roller bearing of the locating types and taper roller bearings.

Limiting Speed

The speeds at which bearings can rotate are limited by the bearing type, the operating load and the permissible operating temperature of the lubricant.

Bearings with low frictional resistance, and correspondingly low internal heat generation, are most suitable for high speeds with proper attention being given to the correct bearing clearance after mounting.

For radial loads the bearings most suitable are deep groove ball bearings or cylindrical roller bearings. For combined loads angular contact bearings should be selected.

Misalignment

Self aligning ball bearings, spherical roller bearings and spherical roller thrust bearings allow, at assembly, for the correction of misalignment where the shaft can be misaligned relative to the housing. Values for permissible angular misalignment are listed in the tables which precede the bearing sizes of those particular types.

Low Noise Level

Even though the running noise of rolling bearings is so low that it is lost in the background noise of other moving parts. It is sometimes of prime importance to reduce this to a minimum level for electric motors used, for example, in lifts for hospitals and hotels, and other domestic appliances. Such applications usually demand the fitting of a deep-groove ball bearing selected for low noise level.

Rigidity

This is sometimes a very important requirement, especially on machine tool spindles, where rigidity controls the bearing selection. In applications of this nature, single or double row cylindrical roller bearings or taper roller bearings are best suited, compared with the point contact of ball bearings. The stiffness can be further enhanced by pre-loading.

Axial Movement

In a normal bearing arrangement supporting a shaft, it is usual to locate one bearing (fixed) and allow the non locating bearing (free) to float in the housing, thus preventing axial pre-load as a result of thermal expansion of the shaft. Axial movement produced by thermal expansion can be accommodated by the use of a cylindrical roller bearing of the N or NU pattern. This allows axial movement to occur by displacement of the rollers over the track.

Tapered Bore And Sleeve Mounting

Tapered bore bearings are used for easier mounting and adjustments of the radial clearance. It is usual to fit sleeve bearings on a bright drawn steel bar, thus cutting machining costs and simplifying assembly. Withdrawal sleeves are used to ease the removal of the bearing. The residual clearance should be checked with the tables relating to the axial drive-up for spherical roller bearings and the bearing size.

Precision

Rolling bearings with a higher degree of precision than normal are required for shafts where running accuracy is of prime importance - for example, machine tools spindles and shafts rotating at very high speeds (see section relating to bearing tolerances).

BEARING LIFE AND LOAD RATINGS

Determination Of Rolling Bearing Size

To determine the size of the bearing, static and dynamic load conditions and design life requirements must be considered. The load ratings for the size and type are given in the bearing tables on the appropriate pages.

Dynamic Loading

When a batch of apparently identical bearings is tested under identical load, speed, and operating conditions, a wide difference is obtained in the lives of the bearings. Typical results are plotted below - this graph shows the 'rating life' (sometimes called the '90 per cent survival life'). This is the calculated life obtained by following the procedure set out in this catalogue. Also shown is the average life, which is appreciably greater than the 'rating life'.

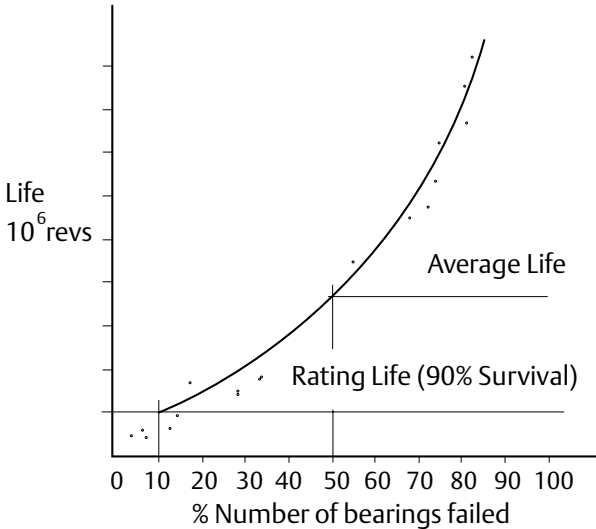

The reason for this difference is that even with the best steel, minute imperfections exist in the material. As the area of contact between the rolling elements and rings under load is very small, these imperfections upset the distribution and intensity of stress in the material. Variations in contact area, resulting from the manufacturing tolerances on the rings and rolling elements, also contribute towards this difference.

In addition to the load conditions on a bearing, failure can also result from other factors - notably, lack of attention to lubrication, protection, or accuracy of mounting. These cannot be included in the basic load/life formulae.

The required basic static load rating C_0 of a bearing can be determined using the equation:

$$C_0 = S_0 P_0$$

where:

C_0 = basic load rating [kN]

P_0 = equivalent static load [kN]

S_0 = static safety factor

For bearings operating in elevated temperatures, the hardness of the bearing material will be reduced.

Values of S_0 for a few typical non rotating bearing applications are shown below and may be used as a guide.

Application	S_0 Factor
Variable pitch propeller blades on aircraft	0.5
Dams on aircraft	1.0
Swing bridges	1.5
Crane hooks for large cranes without additional dynamic forces	1.5
Small cranes for bulk goods with large additional dynamic forces	1.6

On rotating bearings where the load fluctuates dramatically, or where heavy shock loads occur during a fraction of a revolution, it is necessary to check that the basic static load rating is adequate. Heavy shock loads could cause permanent deformation, in the form of indentation being unevenly distributed over the raceway. Shock loads are also generally such that they cannot be calculated exactly. In some cases, they may also cause deformation of the housing, producing unfavorable load distribution. Depending on the operating conditions, the maximum load should not exceed a value determined by the static safety factor S_0 .

Values for S_0 for certain operating conditions can be used.

Operating Conditions	S_0 Factor (min^m)
Operation is smooth and vibration free	0.5
Operation is normal and vibration conditions normal	1.0
Pronounced shock loads	1.5 – 2
Demand on smooth running is of prime importance	2.0
For spherical roller thrust bearing	≥ 4

Basic Dynamic Load Rating Cr

Basic dynamic load rating (C_r) is defined as that constant radial load which a group of apparently identical radial ball bearings, angular contact ball bearings, and radial roller bearings can endure for a rating life of one million revolutions.

For thrust ball bearings the basic dynamic load rating is that constant, central, axial load which a group of apparently identical thrust bearings can endure for a rating life of one million revolutions.

Static Load Rating Co

The static load C_o is defined as a load acting on a non-rotating bearing. Permanent deformations appear in rolling elements and raceways under static load of moderate magnitude and increase gradually with increasing load. The permissible static load is, therefore, dependent upon the permissible magnitude of permanent deformation.

Experience shows that a total permanent deformation of 0.0001 of the rolling element diameter, occurring at the most heavily loaded rolling element and raceway contact, can be tolerated in most bearing applications without impairment of bearing operation.

Rating Life

Rating life (L) is defined as the number of revolutions (or hours at some constant speed) that 90% of a group of apparently identical bearings will exceed before the first evidence of fatigue develops. This may be referred to as B10 life.

LIFE EQUATION

The expression $L_u = (C/P)^3 [10^6 \text{ revs}]$ is used to establish a mathematical relationship for the rating life as a function of the load where:

- L_u = rating life in millions of revolutions of the inner ring with constant direction of loading
- C = basic dynamic load rating in [KN]
- P = equivalent dynamic load rating in [KN]
- p = exponent for life equation
- p = 3 for ball bearings
- p = 10/3 for roller bearings.

In most cases it is common practice to employ the rating life L_h (hours). The relationship between L_u and L_h with constant rotational speed n (rpm) is

$$L_u = \frac{L_h \cdot n \cdot 60}{10^6} \cdot [10^6 \text{ revs}]$$

If the rating life of 1×10^6 revs, to which the basic load rating C refers, is resolved into a reference life $L_h = 500$ hours, and a reference rotation speed of $n = 33.1/3$ rpm it follows that:

for ball bearings for roller bearings: $\left(\frac{C}{P}\right) \cdot \frac{10}{3}$

$$L_u = \frac{L_h \cdot n \cdot 60}{500 \cdot 33.1/3 \cdot 60} = \left(\frac{C}{P}\right)^3 [10^6 \text{ revs}]$$

$$\text{or: } \sqrt[3]{\frac{L_h}{500}} = \sqrt[3]{\frac{33.1/3}{n}} \cdot \frac{C}{P}$$

$$\text{letting: } \sqrt[3]{\frac{33.1/3}{n}} = \text{speed factor } f_n \text{ (equation 1)}$$

$$\text{and: } \sqrt[3]{\frac{L_h}{500}} = \text{life factor } f_L \text{ (equation 2)}$$

The rating life equation may be obtained in the form life factor: $f_L = \frac{C \cdot f_n}{P}$

$$\text{basic load rating required: } C = \frac{P \cdot f_L}{f_n} \quad [KG]$$

The relationship of equation 1 and 2 are graphically represented in nomograms below. Also on page 20 are charts showing the L10 life in relation to C/P for ball and roller bearings.

LIFE “L” IN MILLIONS OF REVOLUTIONS DEPENDING ON C / P

L ₁₀	C / P		L ₁₀	C / P		L ₁₀	C / P	
	Ball bearings	Roller bearings		Ball bearings	Roller bearings		Ball bearings	Roller bearings
0.5	0.793	0.812	240	6.21	5.18	2 000	12.6	9.78
0.75	0.909	0.917	260	6.38	5.30	2 200	13.0	10.1
1	1.00	1.00	280	6.54	5.42	2 400	13.4	10.3
1.5	1.14	1.13	300	6.69	5.54	2 600	13.8	10.6
2	1.26	1.24	320	6.84	5.61	2 800	14.1	10.8
3	1.44	1.39	340	6.98	5.75	3 000	14.4	11.0
4	1.59	1.52	360	7.11	5.85	3 200	14.7	11.3
5	1,71	1,62	380	7.24	5.94	3 400	15.0	11.5
6	1.82	1.71	400	7.37	6.03	3 600	15.3	11.7
8	2.00	1.87	420	7.49	6.12	3 800	15.6	11.9
10	2.15	2.00	440	7.61	6.21	4 000	15.9	12.0
12	2.29	2.11	460	7.72	6.29	4 500	16.5	12.5
14	2.41	2.21	480	7.83	6.37	5 000	17.1	12.9
16	2.52	2.30	500	7.94	6.45	5 500	17.7	13.2
18	2.62	2.38	550	8.19	6.64	6 000	18.2	13.6
20	2.71	2.46	60	8.43	6.81	6 500	18.7	13.9
25	2.92	2.63	650	8.66	6.98	7000	19.1	14.2
30	3.11	2.77	700	8.88	7.14	7500	19.6	14.5
35	3.27	2.91	750	9.09	7.29	8 000	20.0	14.8
40	3.42	3.02	800	9.28	7.43	8 500	20.4	15.1
45	3.56	3.13	850	9.47	7.56	9 000	20.8	15.4
50	3.68	3.23	900	9.65	7.70	9 500	21.2	15.6
60	3.91	3.42	950	9.83	7.82	10 000	21.5	15.8
70	4.12	3.58	1 000	10.0	7.94	12 000	22.9	16.7
80	4.31	3.72	1 100	10.3	8.17	14 000	24.1	17.5
90	4.48	3.86	1 200	10.6	8.39	16 000	25.2	18.2
100	4.61	3.98	1 300	10.9	8.59	18 000	26.2	18.9
120	4.93	4.20	1 400	11.2	8.79	20 000	27.1	19.5
140	5.19	4.40	1 500	11.4	8.97	25 000	29.2	20.9
160	5.43	4.58	1 60	11.7	9.15	30 000	31.1	22.0
180	5.65	4.75	1 700	11.9	9.31			
200	5.85	4.90	1 800	12.2	9.48			
220	6.04	5.04	1 900	12.4	9.63			

NOMOGRAM FOR ESTABLISHING NOMINAL LIFE

Life Calculation Chart

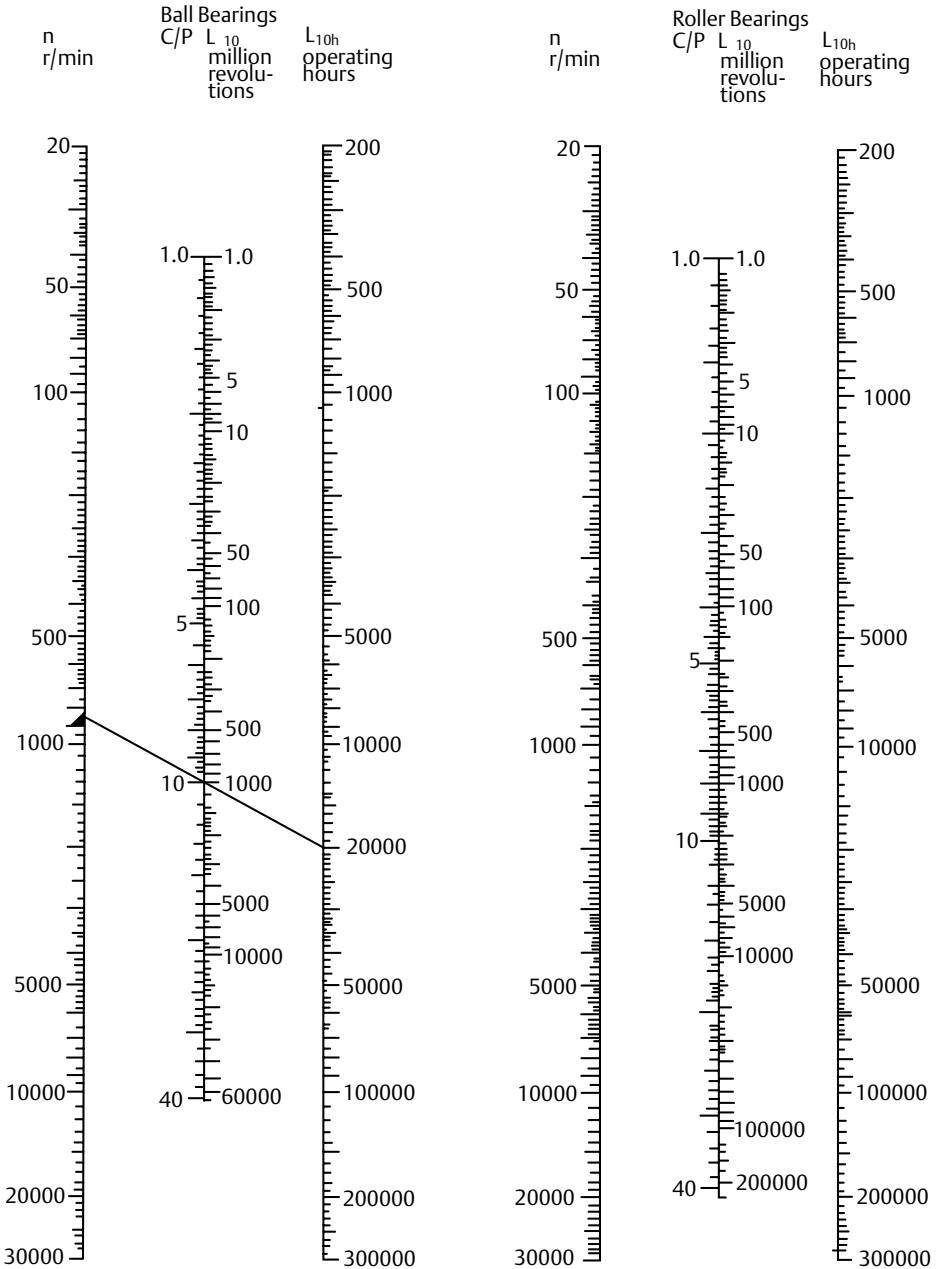

To determine the size of a rolling bearing for a particular field of operation, it is necessary to establish the nominal life corresponding to the field of application.

Example

A deep groove ball bearing is required to run at speed $n=850$ RPM under constant radial load of $F_r = 5$ KN and is to achieve a basic rating life L_{10h} of 20.000 hours.

From the nomogram using the right hand column (L_{10}), a line drawn from 20.000 to the left hand column (n RPM) passes through the centre column (C/P L_{10} 10.6) at 10:1000. Therefore, a bearing is required with a basic load rating C of at least $C = 10 \times 5$ KN. Reading from the tables relating to deep groove ball bearings, it can be seen that a bearing ref 6309 has a C value of 52.7 KN. Of course, the choice of bearing is also governed by the shaft and housing parameters.

For motor vehicles and rolling stock, the service life is expressed as a function of the wheel diameter and kilometers traveled as per formulae below:

$$L_{10} = \frac{1000}{\pi D} \cdot L_{10s}$$

or

$$L_{10s} = \frac{\pi D}{1000} L_{10}$$

where:

- L10 = nominal life in 10^6 RPM
- L10s = life in 10^6 kilometers traveled
- D = diameter of wheel in meters. Values for selecting service life in kilometers covered are in table below.

Vehicle type	L10s/ 10^6 km
Wheel bearings for motor vehicles:	
- cars	0.2
- trucks, buses	0.4
Axle boxes for rolling stock – freight cars	0.8
Suburban traffic	1.5
Long distance coaches	3
Rail cars	3 - 1
Diesel and electric locomotives	3 - 4

Depending on the working temperature of the bearings, their service life is reduced at elevated temperatures.

This is to be taken into consideration when the service life is established by the application of temperature factor f_t specified in the table below:

Working temperature °C	150	200	250	300
Working temperature °F	302	392	482	572
Symbol	S0	S1	S2	S3
f_t	1	0.73	0.42	0.22

In the following table are some recommendations for factor f_v along with typical applications and life factor f_L .

Application	Fields of operating conditions	Factor f_v	Factor f_L
Motor vehicles - gear boxes - axle drives - water pumps - wheel bearings	g – k h – k k h – l	3 – 8 3 – 6 5 – 7 4 – 6	1.7 – 2.2 2 – 3 1.5 – 2 1.6 – 2.5
Railbound vehicles - haulage trolleys - trams - passenger coaches and freight cars - motor coaches and locomotives - gears	f – h e – f c – d d – e c – d	12 – 15 8 – 12 8 – 12 6 – 10 3 – 6	2.5 – 3 3.5 – 4 3 – 3.5 3.5 – 4 3 – 4.5
Motors - electric motors for household appliances - traction motors and standard motors - large motors	i – k c – d b – d	3 – 5 3 – 5 3 – 5	1.5 – 2 3.5 – 4.5 4 – 4.5
Machine-tools - lathe spindles and milling spindles - boring and grinding machine spindles - machine tool gears - electric and pneumatic tools	a – b c – d c – d g – h	0.5 – 1.5 0.5 – 1 3 – 8 3 – 6	3 – 4.5 2.5 – 3.5 3 – 4 1.8 – 2.7
Woodworking machines - milling cutter and cutter shaft - main bearing - rod bearing	e – f e – g c – d	0.5 – 3 3 – 4 2 – 3	3 – 4 3 – 4 2 – 3
Gears general engineering - universal gears - large-sized gears, stationary	d – c c – d	3 – 1 2 – 3	2 – 3 2 – 3
Materials handling - belt drives opencast mining - medium-sized and large fans - centrifugal pumps and compressors	c – d c – l d – f	5 – 12 3 – 5 3 – 5	4 – 6 3 – 4.5 3 – 4.5
Crushers, mills, screens etc. - jaw crushers, roll crushers	f – g	8 – 12	3 – 3.5
Hammer mills - hammer mills and impact mills - tube mills - vibrating mills - vibrating screens	d – c f – g f – g e – f	5 – 8 12 – 18 3 – 5 4 – 6	3.5 – 4.5 3 – 5 2 – 3 2.5 – 3

The wear life diagram indicates the operating conditions, with the least wear factor at curve A and the heaviest wear occurring at curve B. The area between A and B is subdivided into individual fields from a to k. It can be seen that the operating conditions deteriorate progressively.

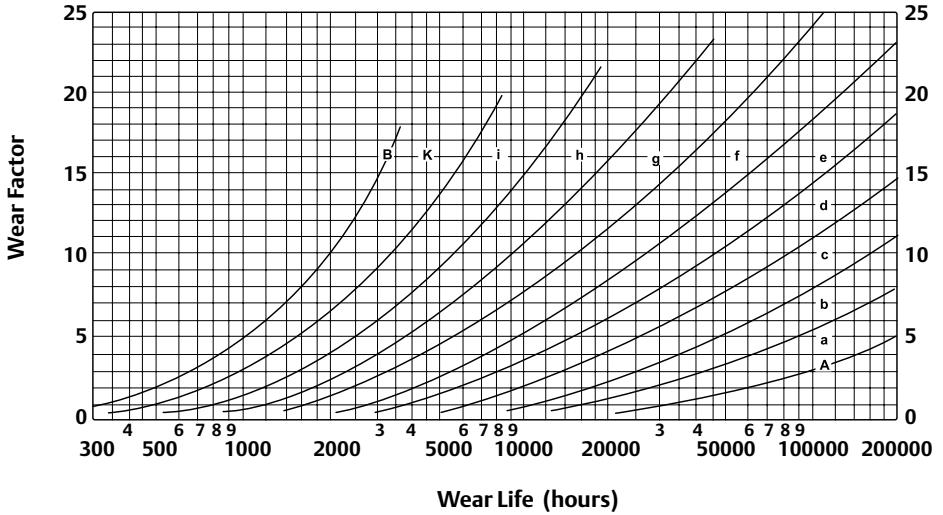

ADJUSTED RATING LIFE

Adjustments to life equations

$$L_{10} = \left(\frac{C}{P}\right)^p$$

The above formula is adequate for conventional applications, but in exceptional cases other factors must be considered which influence the life of the bearing. To accommodate these factors, the ISO life equation is:

$$L_{na} = a_1 \cdot a_2 \cdot a_3 \cdot \left(\frac{C}{P}\right)^p$$

or

$$L_{na} = a_1 \cdot a_2 \cdot a_3 \cdot L_{10}$$

where:

L_{na} = adjusted rating life in 10^6 revolutions the index being the difference between the specified probability life and 100%

a_1 = life adjustment factor for reliability

a_2 = life adjustment for material

a_3 = life adjustment for operating conditions

Calculations for the adjusted rating life are based on the pre-conditions mentioned in the above formulae; for example, that bearing loads can be calculated with accuracy considering all aspects of the loads involved along with shaft deflection etc.

Also, that reliability of the bearing materials are in accordance with the corresponding C values and that normal operating conditions $a_1 = a_2 = a_3 = 1$ and that two life equations become identical.

Life Adjustment Factor A1 For Reliability

The a1 factor is used to determine lives which are obtained or exceeded with a greater probability than 90% (L10). The table below lists the factors for failure probability values between 10% and 1% L10 being the normal rating life.

Probability %	Failure probability %	Life before fatigue appears	Factor a_1
90	10	L10	1
95	5	L5	0.62
95	4	L4	0.53
97	3	L3	0.44
98	2	L2	0.33
99	1	L1	0.21

Life Adjustment Factor A2 For Material

The factor a2 accounts for the properties of the material and its heat treatment. a2=1 is applicable to the high quality steels used in the production of normal bearing series.

Life Adjustment Factor A3 For Operating Conditions

The operating condition factor a3 is primarily determined by bearing lubrication, providing bearing temperatures are not excessive. For elevated temperatures, see reduction in dynamic load rating in table below.

Working temperature °C	150	200	250	300
Working temperature °F	302	392	482	572
Symbol	S0	S1	S2	S3
ft	1	0.73	0.42	0.22

The efficiency of lubrication is determined primarily by the degree of separation between the rolling elements and raceways. The highest life values are reached when there is a hydrodynamic state of lubrication (where metal to metal contact does not exist between rolling elements and raceway), and under the cleanliness conditions which would normally prevail in an adequately sealed bearing arrangement. The a3 factor is based on the viscosity ratio K – this is defined as the ratio of the actual lubricant viscosity V for the viscosity v1 required for adequate lubrication. With thinner lubricating films, there is an increase in metal to metal contact and life expectancy decreases.

Life Adjustment Factor a23

Since a2 and a3 factors are interdependent, the factor combination a23 is used.

$$a_{23} = a_2 \cdot a_3$$

and

$$L_{na} = a_1 \cdot a_{23} \cdot L [10^6 \text{ revs}]$$

Service Life

Since the fatigue life modified by the adjustment factors a1, a2, and a3 only considers material fatigue as the cause of failure, the calculated life corresponds to the service life only if the following points are met:

- (a) Lubrication conditions are constant throughout.
- (b) Loads and speeds used for analysis are a true reflection of the actual operating conditions.
- (c) Operating viscosity is based on actual operating temperature.
- (d) Lubricant contamination is limited during the whole running time.
- (e) The service life limited by wear and break down of lubrication is not shorter than the fatigue life.

Wear of the acting surfaces is primarily caused by contamination which, over a period of time, may penetrate the bearing. The situation is made worse by inadequate lubrication and corrosion due to condensation. The amount of wear experienced in a bearing is dependant on the operating conditions, lubrication, and effective sealing arrangement.

Wear Factor

The permissible amount of wear is expressed by the wear factor fv.

$$fv = \frac{v}{e_o}$$

where:

v = permissible increase in radial clearance (mm)

e_o = bearing constant depending on the bore diameter – see below for

e_o values in relationship with bore diameter mm.

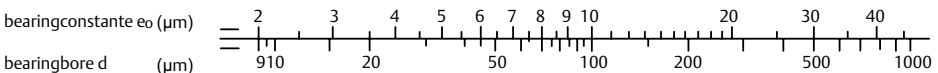

DEEP GROOVE BALL BEARINGS

Equivalent Dynamic Load

$$P = XFr + YFa \quad [Kn]$$

The factors X and Y depend upon the ratio Fa/Co . (The relationship of the axial load to the basic static load) the values shown in the table are applicable to bearings mounted with normal fits – shafts machined to j5 or k5 and housings to j6.

Equivalent Static Load

$$Po = Fr \quad \text{when } Fa / Fr \leq 0.8 \quad [KN]$$

$$Po = 0.6Fr + 0.5Fa \quad \text{when } Fa / Fr \geq 8 \text{ KN}$$

Calculation factors X and Y for deep groove ball bearings:

Fa/Co	Normal radial clearance					Radial clearance C3					Radial clearance C				
	Fa / Fr ≤ e			Fa / Fr > e		Fa / Fr ≤ e			Fa / Fr > e		Fa / Fr ≤ e			Fa / Fr > e	
	e	X	Y	X	Y	e	X	Y	X	Y	e	X	Y	X	Y
0.025	0.22	1	0	0.56	1.2	0.31	1	0	0.46	1.75	0.4	1	0	0.44	1.12
0.04	0.24	1	0	0.56	1.8	0.33	1	0	0.46	1.62	0.42	1	0	0.44	1.36
0.07	0.27	1	0	0.56	1.6	0.36	1	0	0.46	1.46	0.44	1	0	0.44	1.27
0.13	0.31	1	0	0.56	1.4	0.41	1	0	0.46	1.3	0.48	1	0	0.44	1.16
0.25	0.37	1	0	0.56	1.2	0.46	1	0	0.46	1.14	0.53	1	0	0.44	1.05
0.5	0.44	1	0	0.56	1	0.54	1	0	0.46	1	0.56	1	0	0.44	1

Axial Loading Capacity

If deep groove ball bearings are axially loaded this should generally not exceed 0.5 Co. For small bearings and light series the axial load should not exceed 0.25 Co.

DOUBLE ROW SELF-ALIGNING BALL BEARINGS

Equivalent Dynamic Load

$$P = Fr + Y_1 Fa \quad \text{when } Fa/Fr \leq e$$

$$P = 0.65 Fr + Y_2 Fa \quad \text{when } Fa/Fr > e$$

The values for Y_1 , Y_2 and e are given in the bearing tables.

Equivalent Static Load

$$P_0 = Fr + Y_0 Fa$$

The Y_0 values are given in the bearing tables.

Axial Load Capacity When Mounted On Adapter Sleeves

When double row self-aligning ball bearings are mounted on adapter sleeves fitted on smooth shafts, the axial load the bearing will carry depends on the friction between the sleeve bore and the shaft.

The allowable axial load can be calculated by the formula

$$F_{az} = 3 \cdot B d$$

where:

F_{az} = maximum allowable axial load (N)

B = bearing width (mm)

d = bore diameter (mm)

SINGLE ROW ANGULAR CONTACT BALL BEARINGS

Equivalent Dynamic Load

For single row angular contact ball bearings (series 72B and 73B) with contact angle of 40°, the following relations apply for single and tandem mounted bearings:

$$P = F \quad \text{when: } F_a/F_r \leq 1.14$$

$$P = 0.35 F_r + 0.57 F_a \quad \text{when: } F_a/F_r > 1.14$$

For bearing pairs arranged back to back or face to face:

$$P = F_r + 0.55 F_a \quad \text{when: } F_a/F_r \leq 1.14$$

$$P = 0.57 F_r + 0.93 F_a \quad \text{when: } F_a/F_r > 1.14$$

For paired bearings, F_r and F_a are the loads acting on the pair.

Since the loads are transmitted from one raceway to the other in an inclined position, radial loads induce axial reaction forces which must be considered when calculating the equivalent dynamic load. For calculation purposes, the equations show where bearing A and bearing B are subjected to a radial load $F_r A$ and $F_r B$, respectively, and are always considered positive even when they act in the opposite direction to that shown in the figures. The radial loads act at what is termed the "pressure center" of the bearings, which is given in the bearing tables as dimension "a". There is an external force $K_a = 0$; the equations are valid only if the bearings have been adjusted against each other to practically zero clearance and no preload.

SINGLE ROW ANGULAR CONTACT BALL BEARINGS

Bearing Arrangement And Load Equation

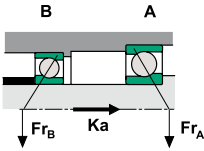

1a) $F_{rA} \geq F_{rB}$
 $K_a \geq 0$

$F_{aA} = 1.14 F_{rA}$
 $F_{aB} = F_{aA} + K_a$

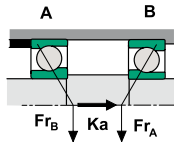

1b) $F_{rA} < F_{rB}$
 $K_a = 1.14 (F_{rB} - F_{rA})$
 1c) $F_{rA} < F_{rB}$
 $K_a < 1.14 (F_{rB} - F_{rA})$

$F_{aA} = 1.14 F_{rA}$
 $F_{aB} = F_{aA} + K_a$
 $F_{aA} = F_{aB} - K_a$
 $F_{aB} = 1.14 F_{rB}$

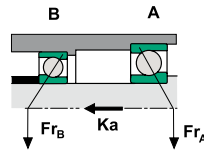

2a) $F_{rA} \leq F_{rB}$
 $K_a \geq 0$

$F_{aA} = F_{aB} + K_a$
 $F_{aB} = 1.14 F_{rB}$

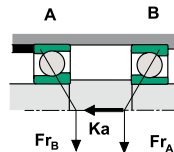

2b) $F_{rA} > F_{rB}$
 $K_a \geq 1.14 (F_{rA} - F_{rB})$
 2c) $F_{rA} > F_{rB}$
 $K_a < 1.14 (F_{rA} - F_{rB})$

$F_{aA} = F_{aB} + K_a$
 $F_{aB} = 1.14 F_{rB}$
 $F_{aA} = 1.14 F_{rA}$
 $F_{aB} = F_{aA} - K_a$

Note: for double row angular contact ball bearings of 32 and 33 series with one piece inner ring:

$P = Fr + 0.73 Fa$ when $Fa/Fr \leq 0.86$
 $P = 0.62 Fr + 1.17 Fa$ when $Fa/Fr > 0.86$

Equivalent Static Load

For single row angular contact ball bearings of the 72 B and 73 B series, for bearings mounted singly or paired in tandem:

$P_o = 0.5 Fr + 0.26 Fa$
 when $P_o < Fr$ $P_o = Fr$ should be used

For bearing pairs arranged back to back or face to face:

$P_o = Fr + 0.52 Fa$

Fr and Fa are the loads acting on the pair of bearings.

Note: for double row angular contact bearings of 32 and 33 series with one piece inner ring:

$P_o = Fr + 0.63 Fa$

Angular Contact Bearings with 15° and 25° Contact Angle (Equivalent load 15° contact angle)

Single bearings and tandem mounted bearings:

$$P = F_r \quad \text{when} \quad \frac{F_a}{F_r} \leq e$$

$$P_o = 0.44 F_r + Y F_a \quad \text{when} \quad \frac{F_a}{F_r} > e$$

The thrust factor Y and values of e are dependant on $\frac{F_a}{iC_o}$ given in tables below.

where:

C_o = static load rating [kN]

i = number of bearings

$\frac{F_a}{i.C_{or}}$	e	Y
0.025	0.4	1.42
0.04	0.42	1.36
0.07	0.44	1.27
0.13	0.48	1.16
0.25	0.53	1.05
0.50	0.56	1

When paired back-to-back or face-to-face

$$P = F_r + Y F_a \quad \text{when} \quad \frac{F_a}{F_r} \leq e$$

$$P = 0.72 F_r + Y F_a \quad \text{when} \quad \frac{F_a}{F_r} > e$$

The thrust factor Y and values of e are dependant on $\frac{F_a}{iC_o}$ given in table below

where C_o = static load rating of the single bearing kN.

$\frac{F_a}{C_{or}}$	e	Fa/Fr ≤ e	Fa/Fr > e
		Y	Y
0.025	0.4	1.6	2.3
0.04	0.42	1.5	2.2
0.07	0.44	1.4	2.1
0.13	0.48	1.3	1.9
0.25	0.53	1.2	1.7
0.50	0.56	1.1	1.6

Equivalent Static Load

Single bearings and tandem mounted bearings:

$$P_o = F_r \quad \text{when } \frac{F_a}{F_r} \leq 1.09$$

$$P_o = 0.5 F_r + 0.46 F_a \quad \text{when } \frac{F_a}{F_r} > 1.09$$

For back to back and face to face arrangements:

$$P_o = F_r + 0.92 F_a$$

Equivalent Load 25° Contact Angle

Single bearings and tandem mounted bearings:

$$P = F \quad \text{when } \frac{F_a}{F_r} \leq 0.68$$

$$P = 0.41 F_r + 0.87 F_a \quad \text{when } \frac{F_a}{F_r} > 0.68$$

For back to back and face to face arrangements:

$$P = F_r + 0.92 F_a \quad \text{when } \frac{F_a}{F_r} \leq 0.68$$

$$P_o = 0.67 F_r + 0.41 F_a \quad \text{when } \frac{F_a}{F_r} > 0.68$$

Equivalent Static Load

Single bearings and tandem arranged bearings:

$$P_o = F_r \quad \text{when } \frac{F_a}{F_r} \leq 1.3$$

$$P_o = 0.5 F_r + 0.38 F_a \quad \text{when } \frac{F_a}{F_r} > 1.3$$

For back to back and face to face arrangements:

$$P_o = F_r + 0.76 F_a$$

CYLINDRICAL ROLLER BEARINGS

The equivalent dynamic radial load of a cylindrical roller bearing subjected to a pure radial load is:

$$P = Fr \text{ [KN]}$$

The equivalent static load of a cylindrical roller bearing subjected to a pure radial load is:

$$Po = Fr \text{ [KN]}$$

The axial dynamic capacity of a roller bearing having ribs on the outer or inner races (types NJ, NUP and HJ) is:

$$F_{az} = \frac{K_1 C_{or} 10^4}{n(d + D)} - K_2 Fr$$

where:

Faz = maximum allowable axial load [N]

Cor = static radial load [N]

Fr = radial component of loading [N]

n = speed [RPM]

d = inner diameter [mm]

D = outer diameter [mm]

K₁ = auxiliary factor, see table

K₂ = auxiliary factor, see table

Factor K₁ and K₂

Lubrication		
Factor	grease	oil
K ₁	10.	6
K ₂	0.005	0.003

The permissible axial load depends on the ability of the roller ends to slide on the surface of the ribs (not fatigue values). It is therefore very important that adequate lubrication is present to assist this and dissipate heat generated by this action. The formula mentioned above is used as a guidance to calculate a suitable axial load along with the “k” factor mentioned in table 2. The formula is based on ideal conditions with (a) maximum temperature differential of up to 60°C (140°F) between ambient and bearing temperature (b) a specific heat elimination of 0.5 mW/mm² C (c) viscosity ratio k 1.5.

“k” indicates an effective viscosity ratio v at working temperatures, against v_1 viscosity required for a satisfactory lubrication of the bearing.

In case of grease lubrication for v ratio, the basic oil viscosity will be used. If viscosity ratio “K” is smaller than 1.5, friction and wear is generated. These can be reduced at lower speeds by use of oils with EP additives.

The thrust loads F_{az} obtained by the formulae are valid for constant axial loadings. For short duration the values can be doubled and may be trebled for shock loads.

For cylindrical roller bearings to function satisfactorily under thrust loads, there must also be radial loads present. The ratio of F_a/F_r should not exceed 0.4.

The axial loading of bearings has, of course, a certain influence upon their service life. This influence can be practically ignored if the F_a/F_r ratio is ≤ 0.2 in case of bearings in series 10, 2, 3, and 4, and $F_a/F_r \leq 0.4$ for bearings in series 22 and 23.

In any case of thrust loads which act upon bearings, factor F_a (N) should not exceed the numerical value of $1.5 D^2$ (D = outer diameter of the bearing in mm).

In case of certain high thrust loads ($F_a \geq D^2$), it is recommended to have the ribs of inner and outer rings completely supported by the integral parts of the shaft & housing.

NUP, NJ and HJ type bearings, which take thrust loads from both directions, should always be so arranged that – if the construction of the bearing permits it – main thrust loads are taken by the ribs.

SPHERICAL ROLLER BEARINGS

Equivalent Dynamic Load

$$P = Fr + Y_1 Fa \quad \text{when } Fa/Fr \leq e$$

$$P = 0.67 \cdot Fr + Y_2 \cdot Fa \quad \text{when } Fa/Fr > e$$

Values for Y_1 , Y_2 and e are given in the bearing tables.

Equivalent Static Load

$$P_o = Fr + Y_o Fa$$

Values for Y_o are given in the bearing tables.

Axial Load Capacity When Mounted On Adapter Sleeves

When spherical roller bearings are mounted on adapter sleeves fitted on smooth shafts, the axial load it will carry depends on the friction between the sleeve bore and the shaft.

The allowable axial load can be calculated by the formula

$$F_{az} = 3 B d$$

F_{az} = maximum permissible axial load [N]

B = bearing width mm

d = bearing bore diameter mm

TAPERED ROLLER BEARINGS

Equivalent Dynamic Load

$$P = Fr \quad \text{where } Fa/Fr \leq e$$

$$P = 0.4 Fr + YFa \quad \text{where } Fa/Fr > e$$

For paired single row tapered roller bearings:

$$P = Fr + Y_1 Fa \quad \text{where } Fa/Fr \leq e$$

$$P = 0.67 Fr + Y_2 Fa \quad \text{where } Fa/Fr > e$$

For paired bearings Fr and Fa are the loads acting on the pair.

Since the loads are transmitted from one raceway to the other in an inclined position, radial loads induce axial reaction forces which must be considered when calculating the equivalent dynamic load. For calculation purposes, the equations show where bearing A and bearing B are subjected to a radial load Fr_A and Fr_B , respectively, and are always considered positive even when they act in the opposite direction to that shown in the figures. The radial loads act at what is termed the "pressure center" of the bearings, which is given in the bearing tables as dimension "a". There is an external force $K_a = 0$; the equations are valid only if the bearings have been adjusted against each other to practically zero clearance and no preload.

TAPERED ROLLER BEARINGS

Bearing Arrangements And Load Equations

$$1a) \frac{F_{rA}}{Y_A} \geq \frac{F_{rB}}{Y_B}; F_{aA} = \frac{0.5F_{rA}}{Y_A};$$

$$F_{aB} = F_{aA} + K_a \quad K_a \geq 0$$

$$1b) \frac{F_{rA}}{Y_A} < \frac{F_{rB}}{Y_B}; F_{aA} = \frac{0.5F_{rA}}{Y_A};$$

$$F_{aB} = F_{aA} + K_a \quad K_a \geq 0.5 \left(\frac{F_{rB}}{Y_B} - \frac{F_{rA}}{Y_A} \right)$$

$$1c) \frac{F_{rA}}{Y_A} < \frac{F_{rB}}{Y_B}; F_{aA} = F_{aB} - K_a;$$

$$F_{aB} = \frac{0.5F_{rB}}{Y_B} \quad K_a < 0.5 \left(\frac{F_{rB}}{Y_B} - \frac{F_{rA}}{Y_A} \right)$$

$$2a) \frac{F_{rA}}{Y_A} \leq \frac{F_{rB}}{Y_B}; F_{aA} = F_{aB} + K_a;$$

$$F_{aB} = \frac{0.5F_{rB}}{Y_B} \quad K_a \geq 0$$

$$2b) \frac{F_{rA}}{Y_A} > \frac{F_{rB}}{Y_B}; F_{aA} = F_{aB} + K_a;$$

$$F_{aB} = \frac{0.5F_{rB}}{Y_B} \quad K_a \geq 0.5 \left(\frac{F_{rA}}{Y_A} - \frac{F_{rB}}{Y_B} \right)$$

$$2c) \frac{F_{rA}}{Y_A} > \frac{F_{rB}}{Y_B}; F_{aA} = \frac{0.5F_{rA}}{Y_A};$$

$$F_{aB} = F_{aA} - K_a \quad K_a < 0.5 \left(\frac{F_{rA}}{Y_A} - \frac{F_{rB}}{Y_B} \right)$$

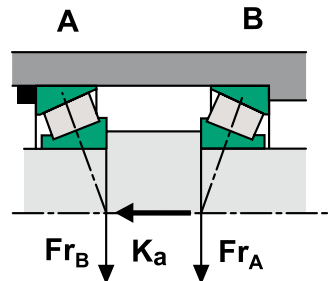
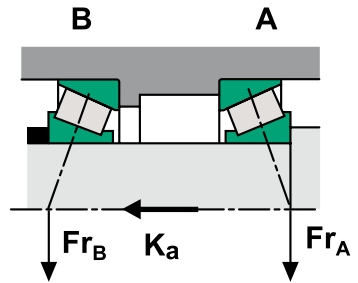
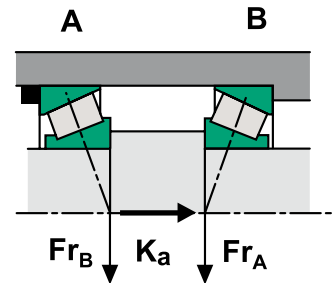
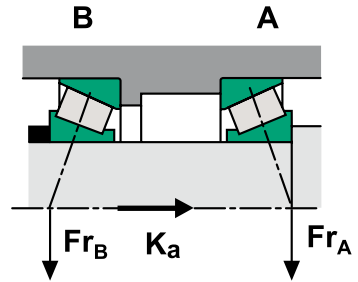

THRUST BALL BEARINGS

Equivalent Dynamic Load

$$P = Fa$$

Where Fa is the axial load (ball thrust bearings can accommodate thrust loads only).

Equivalent Static

$$Po = Fa$$

Ball thrust bearings must have a minimum thrust load to function correctly. This ensures that sliding does not occur due to centrifugal forces acting on the ball and cage assembly.

Minimum Axial Load

This can be calculated from:

$$F_{am} = M \left(\frac{nMax}{1000} \right)^2 \text{ [N]}$$

where:

F_{am} = minimum thrust load [N]

M = factor for minimum load (see tables)

SPHERICAL ROLLER THRUST BEARINGS

Equivalent Dynamic Load

$$P = F_a + 1.2 F_r \quad \text{Providing } F_r \leq 0.55 F_a$$

Equivalent Static Load

$$P = F_a + 2.7 F_r \quad \text{Providing } F_r \leq 0.55 F_a$$

Minimum Axial Load

This can be calculated from:

$$F_{am} = \frac{1.25 C_o}{1000} \text{ [KN]}$$

where:

F_{am} = minimum axial load [KN]

F_r = radial component of load for bearings subjected to combined load [KN]

C_o = basic static load [KN]

In many cases, the axial load acting on the bearing produced by the weight of the supporting component parts and external forces is greater than the required minimum load. If this is not the case, then bearings must be preloaded (for example, using springs).

LIMITING SPEED

The maximum rotational speed of ball and roller bearings depends upon various factors: the size and design of the bearing, type of lubrication (whether grease or oil), and type of cage fitted, along with the internal clearance of the bearing when mounted.

If the radial run-out (which produces out of balance forces) is reduced, then higher speeds can be obtained. Reduction of cage weight will also reduce out of balance forces, such as when made from light alloy or plastic. Cages that are centered on the inner or outer races rather than the rolling elements are used for high speed applications.

With the surface of the riding lips having been specially ground, lubrication between the sliding surfaces must be maintained. Heavier loads influence the speed and also affect the basic rating life of $L_{10h} \leq 75000$ hours.

In such cases, the speeds listed in the tables should be multiplied by a factor f which you can obtain from the fig. 1 below.

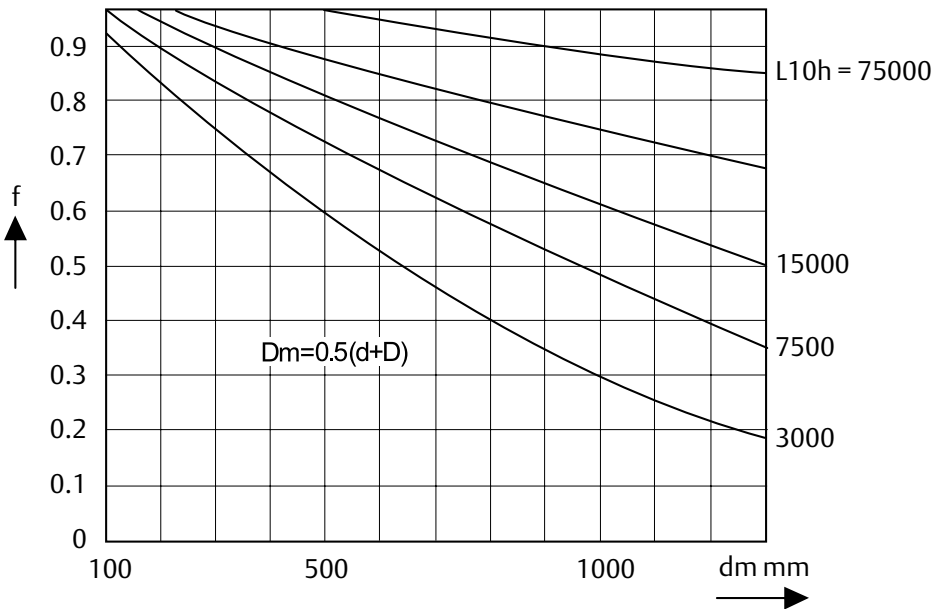

For combined loads, the speeds indicated in the bearing tables are to be multiplied by the reduction factor f_1 given in diagram fig. 2.

Factor f_1

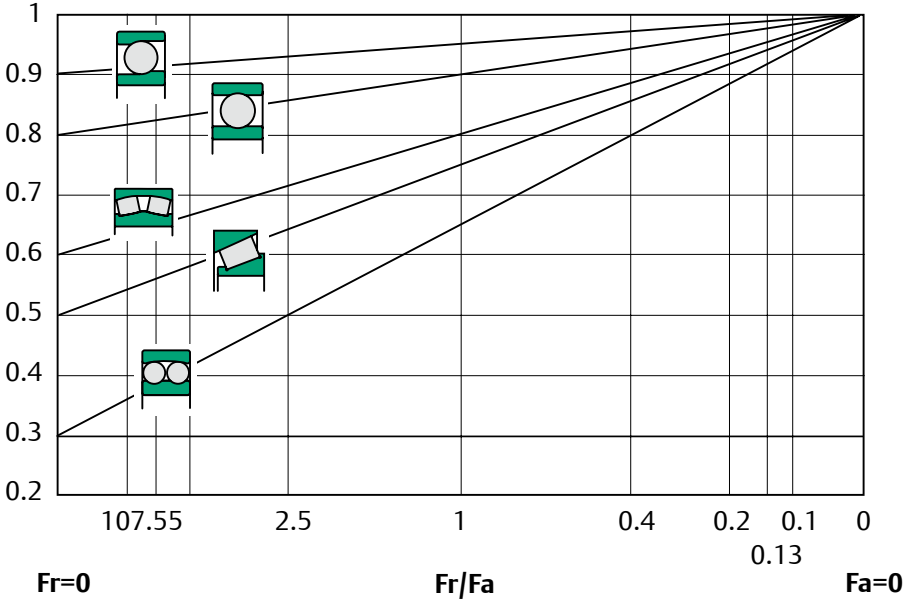

For ball thrust bearings, there must be a minimum load applied to counteract the centrifugal forces of the balls on rotation. Factor M is indicated in the bearing tables against the appropriate bearing size.

BEARING MATERIALS

MATERIALS USED IN THE MANUFACTURING OF ROLLER BEARINGS

Bearing rings and rolling elements are subjected to high stresses on a very small contact area, and must have a high resistance to wear as well as high elastic and fatigue limits. Primarily these are manufactured from high-carbon chromium bearing steel with a chemical composition as indicated in table below, and are in accordance with SAE 52100 - 100Cr6.

HIGH CARBON CHROMIUM BEARING STEEL

Steel Grade		Chemical Composition %					
		C	Mn	Si	Cr	S	P
ROL1	100 Cr6	0.90..1.05	0.25..0.40	0.15..0.35	1.40..1.65	<0.025	<0.025
	100 CrMnSi6-4	0.90..1.05	1.00..1.20	0.50..0.70	1.40..1.60	0.020	<0.025
ROL2 (GMEX)		0.94~1.04	0.25~0.45	0.15~0.35	1.40~1.60	≤0.012	≤0.020

For large bearings that are subjected to high shock loads, carburized low carbon alloy steels are used. Such steels, when carburized to the correct depth, have the added advantage of having a hard surface - and because the core is softer, it is more energy absorbing.

CAGE MATERIALS

Types of cages for bearings vary in accordance with the operating conditions. The most common are those made from pressed steel. Machined cages are made from high strength copper alloys or carbon steel, and for high speeds manufactured from plastic or phenolic resins.

HEAT TREATMENT

Bearings are generally used up to a temperature of maximum + 150°C (+302°F). In case of higher temperatures, bearings with special heat treatments should be used. Sealed bearings, 2RS type, should be used at operating temperatures up to +80°C (+176°F). If this temperature is exceeded, the efficacy of lubricants is considerably reduced.

In order to use bearings at a higher operating temperature, the bearings have to be subjected to a special heat treatment. This will ensure the dimensional stability, but will reduce the lifetime by a factor (ft) as per the table below.

Operating temp °C	150	200	250	300
Working temperature °F	302	392	482	572
Symbol	S0	S1	S2	S3
ft	1	0.73	0.42	0.22

SUFFIXES AND PREFIXES

SUPPLEMENTARY DESIGNATION

Prefixes

- S - Stainless steel components
- K - Stainless steel components
- L - Removable inner or outer ring
- R - Removable bearing with no inner ring
- F - Shaft washer of thrust ball bearing
- W - Housing washer of thrust ball bearing
- WS - Shaft washer of thrust roller bearing
- GS - Housing washer of thrust roller bearing

Suffixes

Modifications to internal design of bearings.

Deep Groove Ball Bearings

- EMQ - Electric motor quality

Single Row Angular Contact Ball Bearings

- A - Contact angle of 25°
- B - Contact angle of 40°
- C - Contact angle of 15°

Tapered Roller Bearings

- A - Increased loading capacity

Cylindrical Roller Bearings

- E - Increased loading capacity
- NA - Non-interchangeable components
- M - Brass cage guided on the rollers
- EM - Increased loading capacity and brass cage guided on the rollers
- EMA - Increased loading capacity and brass cage guided on the outer ring

Spherical Roller Thrust Bearing

- EM - Increased loading capacity and new brass cage

Spherical Roller Bearings

- C - Pressed steel cage and loose guide ring
- CA - one piece brass cage, guided on the rollers.
Assymetrical roller position
- GMEX - Improved precision, roundness and surface finish, rings and rollers are manufactured in high grade ROL2 steel, one piece robust brass cage, guided on the rollers.
- MB - 2 piece brass cage , guided on the inner ring
- VS C4 F80 - Special bearing for vibration screen application, $d < 320$
- MA C4 F80 - Special bearing for vibration screen application, $d > 320$

Modifications to external design of bearings

- X - Boundary dimensions altered according to ISO
- K - Bearings with tapered bore 1:12
- K30 - Bearings with tapered bore 1:30
- R - Flange on outer ring of bearing
- N - Snap ring groove on outer ring of bearing
- NR - Snap ring groove with snap ring
- N2 - Diametrically opposed notches on outer ring corner
- RS - Seal on one side of bearing
- 2RS - Seals on both sides of bearing
- Z - Shield on one side of bearing
- ZZ - Shields on both sides of bearing
- TM - Polyamide cage

LUBRICATION

ROLLING BEARING LUBRICATION

The main duties of introducing lubricants into ball and roller bearings, apart from protecting the finely finished surfaces when rotating at high speeds, is to reduce friction between the rolling elements, the separator or cage, and the races at any point where true rolling is absent. Lubrication also assists in dissipating heat, and sealing the bearing against the entry of contaminants such as dust and moisture.

Rolling bearings may be lubricated with oil or grease. The choice of lubricant is usually decided by temperature, speed, load, and operating conditions along with bearing design. We summarise as follows:

1. The size of bearing governs the viscosity of the lubricant – the larger the bearing the higher should be the viscosity. Regarding size, rolling bearings can be divided into four sizes depending on the outside diameter:

Very small bearings	$D \leq 22 \text{ mm}$
Small bearings	$D \leq 62 \text{ mm}$
Medium bearings	$62 \leq D \leq 240 \text{ mm}$
Large bearings	$D \geq 240 \text{ mm}$

2. Speed has an influence upon the viscosity of the lubricant because the resisting force, opposed to the moving parts by the lubricant, depends on its viscosity. The higher the revolution speed, the lower the viscosity of the lubricant should be.

The revolution speed may be:

Normal $n \leq 75\%$ of the limit speed specified in the tables

High $75\% \leq 100\%$ of the limit speed specified in the tables

Very high $n \geq 100\%$ of the limit speed specified in the tables. For very high revolution speeds, oil lubrication is required to transfer frictional heat or other sources of heat away from the bearing.

3. Equivalent loading capacity, $P = XFr + YFa$, conditions the viscosity grade of the lubricant, due to specific pressure which appears between the contact surfaces. The higher this is, the greater the resistance of the lubricant film should be, and the respective viscosity.

Loads may vary as follows:

normal loads where

$P/Cr \leq 0.1$ for bearings within diameter ranges 1, 2 and 3.

$P/Cr \leq 0.15$ for bearings within diameter range 4.

high loads where

$P/Cr \geq 0.1$ for bearings within diameter ranges 1, 2 and 3.

$P/Cr \geq 0.15$ for bearings within diameter range 4.

P = equivalent dynamic load [kN]

Cr = basic dynamic load [kN]

4. The operating temperature affects selection of lubricants, as it is an influence upon viscosity. Therefore, each lubricant is used only within the limits of certain clearly defined temperature ranges.

GREASE LUBRICATION

Although oil is the better lubricant, grease is often preferred because of the following natural advantages:

- Grease helps to form an effective closure between the shaft and housing, thus preventing the ingress of dirt, moisture and other corrosive agents.
- Grease protects the finely finished working surfaces of a bearing by clinging to them, particularly when the bearing is not in motion. Oil tends to drain away, leaving the surfaces open to attack.
- Grease is easier to retain within the housing than oil. This is of great help in the food, printing, textile, chemical and other industries where contamination or staining can ruin the product.
- Grease is convenient to handle, and re-lubrication of bearings is quick and clean. Planned lubrication cycles are often possible, resulting in smaller labour costs.

Whatever type of grease is used, it should have no tendency to separate under operating conditions. When separation occurs, the oil runs out of the bearing and leaves behind dry soap, which hardens and cakes. This interferes with the movement of the rolling element, which may result in overheating and mechanical failure. Excessive softening is also undesirable, because the grease might then leak out of the bearing and leave working surfaces unprotected.

The quantity of grease used for the lubrication of a rolling bearing should not be too great, as a tightly packed bearing is liable to overheat if operated at high speed. Relubrication intervals depend on the bearing type, inner diameter and revolution speed for filling with fresh grease. The quantity required is given in the following equation:

$$G = 0.005 \text{ DB grams}$$

where:

D = outer diameter (m/m)

B = width (m/m)

After a certain number of refills, it is necessary to remove old grease completely using a suitable solvent. Never mix two grades of grease.

OIL LUBRICATION

Oil is sometimes more convenient to use than grease, and there are circumstances when it is definitely preferred. These are as follows:

- When frictional resistance in light machinery and instruments must be kept low.
- Where either the speed or the temperature is too high for grease lubrication.
- Where high temperature and heavy load occur together, with or without high speed.
- Where the bearings are enclosed in a casing that contains other components lubricated by oil, e.g. a gearbox.

A good quality mineral oil should be used of a viscosity to suit the operating conditions involved. Vegetable or animal oils are not recommended as these can become rancid under certain conditions and cause corrosion problems. A small supply of oil is required to lubricate the bearings; a more copious supply should be used if the bearing must be kept cool, when it is often advantageous to use a synthetic oil to cope with the temperature conditions.

Limiting temperature for mineral oil is about 150°C (302°F) and for synthetic oils about 220°C (428°F).

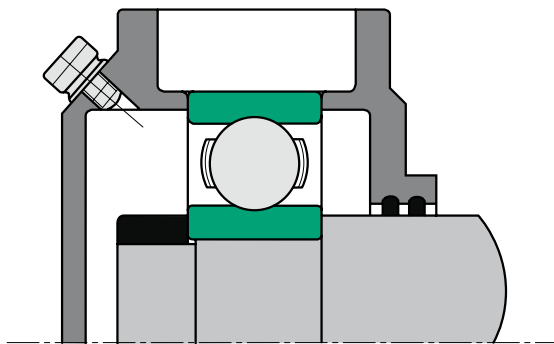

Typical Grease Lubrication

METHODS OF OIL LUBRICATION

Methods of oil lubrication for rolling bearings include oil bath, oil circulation, oil splash and oil mist.

Oil Bath

This method is suitable for horizontal shaft applications. The oil should reach the center of the bottom ball or roller in the bearing; a greater depth than this could cause overheating due to churning of the oil. The surface area and volume of the oil in the bath should be sufficiently large to maintain an adequate depth of oil for the cage to dip into when running. Sight oil level indicators can be used. Alternatively, a tapped and plugged hole can be provided at the correct level; when replenishing the oil, the plug is removed and oil added until it starts to escape through the hole. The plug should, of course, be replaced before the machine is started!

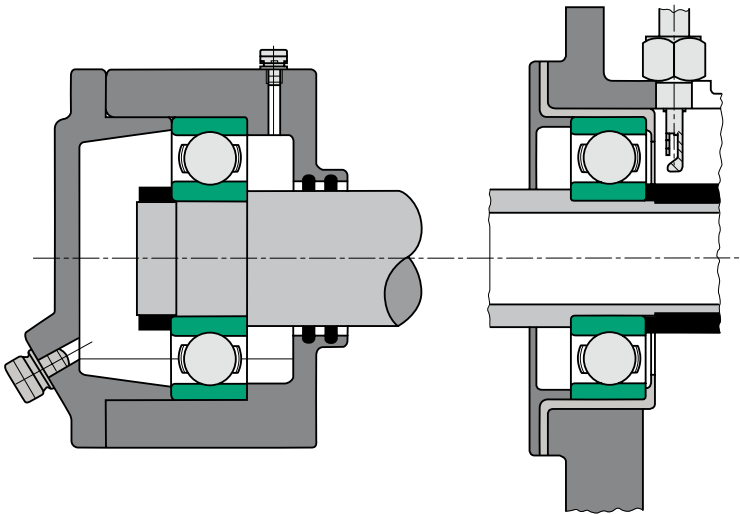

Oil Bath

Pump feed

Pump-Feed Lubrication

This is especially suitable for heavily loaded, high-speed bearings, since such conditions can result in bearing temperatures well in excess of 100°C (212°F). Oil is pump-fed to each bearing, being directed by jets on to the outside diameter of the inner ring so that some of it gains access to the internal parts of the bearing. Each bearing may require from 45 to 140 litres of oil per hour, although most of this only flushes the face of the bearing to keep it cool. A reservoir is often provided to lubricate the bearing during starting: alternatively, the pump can be started before the machine is set in motion so that the bearing never runs unlubricated.

Splash Lubrication

This is suitable when the bearings are enclosed in a casing, such as a gearbox, and the oil used to lubricate the gears is distributed sufficiently to lubricate the bearings. The oil is either splashed directly on to the bearings or collected in galleries and directed to the bearings. The drawing below illustrates how the oil is made to pass through the bearing before it returns to the gearbox casing.

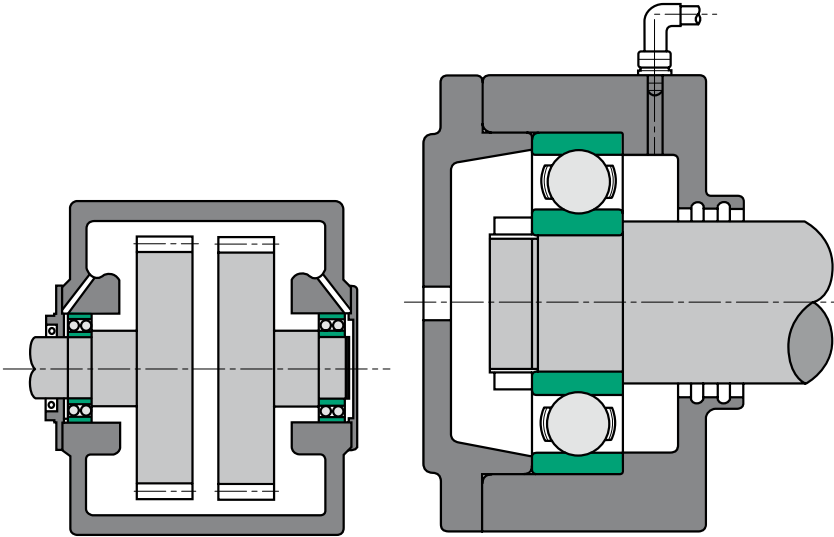

Oil Splash

Oil Mist

Oil Mist System

One important advantage of this method of lubrication is that only a small quantity of oil is required, carried in a stream of compressed air. The oil mist equipment should be turned on before the machine is set in motion so as to ensure that the bearings are constantly covered by a thin film of oil when rotating.

Oil mist is advantageous for applications such as machine tools (where it can also be used to lubricate slideways, gears, chains and other components), since the air escaping from the bearing housing prevents the ingress of foreign matter. The flow of air also keeps the bearing cool. It is important that the compressed air used is absolutely clean and dry.

HANDLING OF BEARINGS

Care & fitting of bearings

Storage

1. Store ball and roller bearings in a clean, dry place in their original wrappings. This will preserve them from deterioration.
2. Use older stock first.
3. Do not stack too many large bearings on top of each other. This can cause the protective oil to be squeezed out from between the bearing and its wrapping, thus leading to corrosion problems. Also, never store large bearings upright, but lay them flat.

Fitting

4. Absolute cleanliness is essential when handling bearings. They should not be removed from their wrappings until required for fitting. A smooth, metal-topped bench that can be wiped clean is a great advantage. All tools, shafts, housings and other components must be perfectly clean. If fitting operations are delayed or interrupted, the assembly should be wrapped with greaseproof paper to exclude dirt and dust.
5. Bearings are usually coated with a rust-preventative oil, unless pre-lubricated and/or packed to suit individual requirements. There is no need to remove this oil unless:
 - It is sufficient to cause serious dilution of the oil or grease used in the bearing. This normally applies to smaller bearings where the rust-preventative oil represents a large proportion of the required amount of lubricant.
 - Low torque is required.
 - A synthetic lubricant is used that may not be compatible with the protecting oil.

To remove the rust preventive oil, wash the bearing in a good quality cleaning fluid. Allow the bearings to drain thoroughly and dry them. The following are satisfactory methods for drying:

- Place the bearing in an oven or on a hot plate with a temperature of 65-80°C (149-176°F).
- Direct dry, clean, compressed air on to the bearings. The cage and rings of smaller bearings must be held firmly. A sudden blast of air can rapidly accelerate the free bearing parts, causing the balls to skid and damaging the highly finished internal surfaces of the bearing.

6. The fitting of the rings on their seatings are very important. Therefore, ensure that the shaft and housing seatings are of correct size and of good shape.
7. All shoulders must be smooth and square with the axis of rotation.
8. Never drive one ring on to its seating by blows on the other. Such blows cause damage to the balls or rollers and raceways.
9. Apply pressure evenly around the rings. A press is better than a hammer.
10. Should a hammer be used, a mild steel or brass tube of suitable size should be interposed between it and the bearing. This will distribute the force of the taps, which should be given progressively around the ring.
11. When the inner ring, outer ring and rollers of a separable roller bearing are brought together, they must be properly in alignment with each other. When not aligned, the rollers are unable to slide freely, and force would need to be used to bring the parts together. Such force would result in the rollers and raceways becoming scored. This, in addition to causing noisy running, can cause early failure of the bearing.
12. Where the ring of a bearing is to be against an abutment, make sure it is properly seated.
13. For heavy interference fits, inner rings may be shrunk onto their seatings after heating in clean mineral oil at a temperature of approximately 100%. Confirm that the bearing is in contact with the abutment shoulder after it has cooled.
14. In the case of taper clamping sleeve and nut bearings, the clamping nut must not be over-tightened. This can expand the inner ring and eliminate all clearance within the bearing, or even fracture the inner ring.

It is recommended that when using pin spanners, they have a length of approximately five times the shaft diameter. After the nut has been tightened as much as possible by hand pressure, one or two light hammer blows should be given to the handle of the spanner; this should tighten the nut sufficiently. It is good practice, if possible, to check that the sleeve is still clamped firmly to the shaft after a few days running.

As an additional precaution it is recommended that, whenever possible, the bearings are fitted so that the rotation of the shaft tends to tighten the nut on the sleeve.

When using torque spanners, it is recommended that the following torques be applied to the clamping nut:

For *LIGHT* series bearings:

Shaft Diameter	Torque on Nut
1" and 25m/m	7.6 Kgm/M (55 lbs ft)
1 1/2" and 40 m/m	12.4 Kgm/M (90 lbs ft)
2" and 50 m/m	17.25 Kgm/M (125 lbs ft)
3" and 75 m/m	30.3 Kgm/m (220 lbs ft)

For *MEDIUM* series bearings, increase the above figures by approximately 50 percent.

Dismantling And Replacement

15. Unnecessary removal of a bearing should be avoided, particularly where interference fits have been used. Removal can damage a bearing and, in some instances, cause deterioration of the interference fit. Very often it is sufficient to clean and relubricate the bearing in its fitted position.

Only remove a bearing if you need to inspect it closely. Symptoms that may require close inspection are the condition of the lubricant, the bearing temperature and noise level.

16. Sometimes a ball locating bearing is installed with roller journal bearings. This may be only push fit on the shaft, and therefore easily dismantled.

17. In certain applications, some form of extractor may be necessary. This must act directly on the ring to be removed. Never try to remove the inner ring by applying force to the outer ring, or vice versa.

18. Thrust bearings are usually installed with push fits, and should offer no difficulty. Take care to keep the rings aligned, however, to prevent them from binding.

19. Carefully protect bearings from dirt and moisture while they are out of their housings. It is advisable to wash them thoroughly immediately after removal, using the following procedure:
- Immerse in a washing fluid, such as clean white spirit or good-quality paraffin. The washing fluid must not attack the bearing components. After soaking, move each separate bearing around in the fluid, using a basket or other container if convenient. Occasional slow oscillations of the bearing rings will help to dislodge dried out grease and other matter.
 - When clean, thoroughly drain and dry.
 - Lubricate the bearing immediately and re-fit. Alternatively, completely coat all parts with a rust preventative oil, working it well into the internal parts of the bearing. Then wrap the bearing in greaseproof paper and box until required for re-fitting, when the bearing will require re-lubricating.
20. Worn shafts, housings and abutments must have attention if creep has occurred. Do not resort to knurling, scoring, or distortion of the seating on which creep has occurred in order to simulate an interference fit. Such deceptive practices are ineffective, and creep will quickly return. In addition, even if the ring is prevented from creeping it will usually be distorted by the seating, resulting in bearing failure due to local overloading of the raceways and of the balls or rollers.

RADIAL INTERNAL CLEARANCE

Radial clearance is the total internal clearance between the balls or rollers in a bearing and their raceways, measured normal to the axis of the bearing. This clearance compensates for:

- expansion of the inner ring and/or contraction of the outer ring when interference fits are used
- for differential expansion of the two ring when the inner ring of a bearing operates at a higher temperature than the outer ring
- affects the end play of ball bearings and also affects their capacity for carrying axial loads – the greater the radial clearance, the greater the capacity for supporting axial load.

When bearings with small radial clearances are used, special attention must be given to the selection of seating dimensions.

Once ball and roller bearings are mounted and running, a small amount of radial or running clearance is normally desirable. In the case of bearings under radial load, quieter running is generally obtained when this clearance is at minimum.

Radial clearance figures for ball and roller bearings mentioned in our tables are in accordance with I.S.O. recommendations.

For normal applications, the general guide given in Table 1 below may be used. Excessive radial tightness in the bearing should be avoided under all conditions.

Table 1 – Summarizing The Correct Radial Clearance

Radial clearance of bearing	Fit of races on seating	Possibility of temperature changes reducing radial clearance
C2	No appreciable interference either race	absent
CN	One race only interference fit	absent
C3	One race only interference fit	present
C3	Both races interference fit	absent
C4	Both races interference fit	present

- C2 fit** These bearings have the smallest amounts of radial clearance. They should only be used where freedom from all play is required in the assembled bearing, and there is no possibility of the initial radial clearances being eliminated by external causes. Therefore, special attention must be given to the seating dimensions, as the expansion of the inner ring or contraction of the outer ring may cause tight bearings.
- CN fit** This grade of radial clearance is intended for use where only one ring is made interference fit, and there is no appreciable loss of clearance due to temperature differences. Ball and roller bearings for general engineering applications are usually of this clearance.
- C3 fit** This grade of radial clearance should be used when both rings of a bearing are made an interference fit, or when only one ring is an interference fit but there is likely to be some loss of clearance due to temperature differences. It is the grade normally employed for roller journal bearings on general engineering applications, especially where there is a tendency for “creep” to take place due to out-of-balance loading.
It is also the grade normally used for ball bearings that take axial loading, but for some purposes even “C4” fit bearings may be required.
- C4 fit** This is the grade of radial clearance to adopt when there will be some loss of clearance due to temperature differences and both races must be an interference fit. One example of its use is in bearings for traction motors.

Where seating limits give an interference fit tighter than the recommended figures, or where temperature differences could cause radial tightness, the correct clearance can be established by calculating the maximum loss of clearance at both extremes of the following basis. A suitable clearance grade from the tables can then be selected.

Total lost of clearance = $RI + RO + RT + RM$

RI = Expansion of inner ring raceway due to shaft interference. (See table below).

RO = Contraction of outer ring raceway due to housing interference. (See table below).

RT = Loss of clearance due to the inner ring being at a higher temperature than the outer ring.

RM = Loss of clearance due to increase in seating interference, resulting from nonferrous seating expanding or contracting at different rates from bearing steel.

Table 2 below gives approximate values for RO and RI assuming a solid shaft and substantial housing.

Table 2

Bearing series	Inner ring raceway expansion RI	Outer ring raceway Contraction RO
Extra light	100% interference	80% interference
Light	80% interference	60% interference
Medium and heavy	70% interference	50% interference

INTERNAL BEARING CLEARANCE

SINGLE ROW AND DOUBLE ROW DEEP GROOVE BALL BEARINGS

With Cylindrical Bore

Clearance to ISO 5753-2009

Normal bore diameter d mm		Symbol of clearance group									
		C2		normal		C3		C4		C5	
over	up to	Radial clearance of bearing μm									
		min.	max.	min.	max.	min.	max.	min.	max.	min.	max.
2,5	10	0	7	2	13	8	23	14	29	20	37
10	18	0	9	3	18	11	25	18	33	25	45
18	24	0	10	5	20	13	28	20	36	28	48
24	30	1	11	5	20	13	28	23	41	30	53
30	40	1	11	6	20	15	33	28	46	40	64
40	50	1	11	6	23	18	36	30	51	45	73
50	65	1	15	10	30	25	43	38	61	55	90
65	80	1	15	8	28	23	51	46	71	65	105
80	100	1	18	12	36	30	58	53	84	75	120
100	120	2	20	15	41	36	66	61	97	90	140
120	140	2	23	18	48	41	81	71	114	105	160
140	160	2	23	18	53	46	91	81	130	120	180
160	180	2	25	20	61	53	102	91	147	135	200
180	200	2	30	25	71	63	117	107	163	150	230
200	225	2	35	25	85	75	140	125	195	175	265
225	250	2	40	30	95	85	160	145	225	205	300
250	280	2	45	35	105	90	170	155	245	225	340
280	315	2	55	40	115	100	190	175	270	245	370
315	355	3	60	45	125	110	210	195	300	275	410
355	400	3	70	55	145	130	240	225	340	315	460
400	450	3	80	60	170	150	270	250	380	350	510
450	500	3	90	70	190	170	300	280	420	390	570
500	560	10	100	80	210	190	333	310	470	440	630
560	630	10	110	90	230	210	360	340	520	490	690
630	710	20	130	110	260	240	400	380	570	540	780
710	800	20	140	120	290	270	450	430	630	600	840
800	900	20	160	140	320	300	500	480	700	670	940
900	1000	20	170	150	350	330	550	530	770	740	1040
1000	1120	20	180	160	380	360	600	580	850	820	1150
1120	1250	20	190	170	410	390	650	630	920	890	1260
1250	1400	30	220	200	450	430	710	680	1100	980	1380

With Tapered Bore

Normal bore diameter d		Symbol of clearance group							
		C2		normal		C3		C4	
mm over	up to	Radial clearance of bearing μm							
		min.	max.	min.	max.	min.	max.	min.	max.
2,5	10	2	13	8	23	14	29	20	37
10	18	3	18	11	25	18	33	25	45
18	24	5	20	13	28	20	36	28	48
24	30	5	20	13	28	23	41	30	53
30	40	6	20	15	33	28	46	40	64
40	50	6	23	18	36	30	51	45	73
50	65	8	28	23	43	38	61	55	90
65	80	10	30	25	51	46	71	65	105
80	100	12	36	30	58	53	84	75	120
100	120	15	41	36	66	61	97	90	140
120	140	18	48	41	81	71	114	105	160
140	160	18	53	46	91	81	130	120	180
160	180	20	61	53	102	91	147	135	200
180	200	25	71	63	117	107	163	150	230
200	225	25	85	75	140	125	195	175	265
225	250	30	95	85	160	145	225	205	300
250	280	35	105	90	170	155	245	225	340
280	315	40	115	100	190	175	270	245	370
315	355	45	125	110	210	195	300	275	410
355	400	55	145	130	240	225	340	315	460
400	450	60	170	150	270	250	380	350	510
450	500	70	190	170	300	280	420	390	570
500	560	80	210	190	333	310	470	440	630
560	630	90	230	210	360	340	520	490	690
630	710	110	260	240	400	380	570	540	780
710	800	120	290	270	450	430	630	600	840
800	900	140	320	300	500	480	700	670	940
900	1000	150	350	330	550	530	770	740	1040
1000	1120	160	380	360	600	580	850	820	1150
1120	1250	170	410	390	650	630	920	890	1260
1250	1400	200	450	430	710	680	1100	980	1380

SINGLE ROW ANGULAR CONTACT BALL BEARINGS

Axial clearance of single row angular contact ball bearings arranged in “DB” and “DF” pairs

Series 72...B		Series 73...B		Axial clearance value	
Normal bore diameter d mm		Normal bore diameter d mm		µm	
over	up to	over	up to	min.	max.
10	30	15	25	16	36
30	50	25	40	17	47
50	80	40	70	25	65
80	150	70	100	25	76
-	-	100	190	35	95

Radial clearance ≈ 0,84 axial clearance

AXIAL CLEARANCE OF DOUBLE ROW ANGULAR CONTACT BALL BEARINGS

Normal bore diameter d mm		Series 32 and 33						Series 33D	
		C2		normal		C3		normal	
		Axial clearance of bearing µm							
over	up to	min.	max.	min.	max.	min.	max.	min.	max.
-	10	1	11	5	21	12	28	-	-
10	18	1	12	6	23	13	31	-	-
18	24	2	14	7	25	16	34	-	-
24	30	2	15	8	27	18	37	-	-
30	40	2	16	9	29	21	40	33	54
40	50	2	18	11	33	23	44	36	58
50	65	3	22	13	36	26	48	40	63
65	80	3	24	15	40	30	54	46	71
80	100	3	26	18	46	35	63	55	83
100	110	4	30	22	53	42	73	65	96

Radial clearance ≈ 0,6 axial clearance

AXIAL CLEARANCE OF FOUR POINT CONTACT BEARINGS

Normal bore diameter d mm		Symbol of clearance group							
		C2		normal		C3		C4	
		Axial clearance of bearing µm							
over	up to	min.	max.	min.	max.	min.	max.	min.	max.
10	17	15	55	45	85	75	125	115	165
17	40	26	66	56	106	96	146	136	186
40	60	36	86	76	126	116	166	156	206
60	80	46	96	86	136	126	176	166	226
80	100	56	106	96	156	136	196	186	246
100	140	66	126	116	176	156	216	206	266
140	180	76	156	136	196	176	246	226	296

Radial clearance ≈ 0,7 axial clearance

DOUBLE ROW SELF-ALIGNING BALL BEARINGS With Cylindrical Bore

Clearance to ISO 5753-2009

Normal bore diameter d		Symbol of clearance group							
		C2		normal		C3		C4	
mm		Radial clearance of bearing μm							
over	up to	min.	max.	min.	max.	min.	max.	min.	max.
2,5	6	1	8	5	15	10	20	15	25
6	10	2	9	6	17	12	25	19	33
10	14	2	10	6	19	13	26	21	35
14	18	3	12	8	21	15	28	23	37
18	24	4	14	10	23	17	30	25	39
24	30	5	16	11	24	19	35	29	46
30	40	6	18	13	29	23	40	34	53
40	50	6	19	14	31	25	44	37	57
50	65	7	21	16	36	30	50	45	69
65	80	8	24	18	40	35	60	54	83
80	100	9	27	22	48	42	70	64	96
100	120	10	31	25	56	50	83	75	114
120	140	10	38	30	68	60	100	90	135
140	160	15	44	35	80	70	120	110	161

With Tapered Bore

Clearance to ISO 5753-2009

Normal bore diameter d		Symbol of clearance group							
		C2		normal		C3		C4	
mm		Radial clearance of bearing μm							
over	up to	min.	max.	min.	max.	min.	max.	min.	max.
18	24	7	17	13	26	20	33	28	42
24	30	9	20	15	28	23	39	33	50
30	40	12	24	19	35	29	46	40	59
40	50	14	27	22	39	33	52	45	65
50	65	18	32	27	47	41	61	56	80
65	80	23	39	35	57	50	75	69	98
80	100	29	47	42	68	62	90	84	116
100	120	35	56	50	81	75	108	100	139
120	140	40	68	60	98	90	130	120	165
140	160	45	74	65	110	108	150	140	191

SINGLE ROW, DOUBLE ROW CYLINDRICAL ROLLER BEARINGS

With Interchangeable Component Parts With Cylindrical Bore

Clearance to ISO 5753-2009

Bore diameter d mm		Clearance group symbol									
		C2		normal		C3		C4		C5	
over	up to	min.	max.	min.	max.	min.	max.	min.	max.	min.	max.
	24	0	25	20	45	35	60	50	75	65	90
24	30	0	25	20	45	35	60	50	75	70	95
30	40	5	30	25	50	45	70	60	85	80	105
40	50	5	35	30	60	50	80	70	100	95	125
50	65	10	40	40	70	60	90	80	110	110	140
65	80	10	45	40	75	65	100	90	125	130	165
80	100	15	50	50	85	75	110	105	140	155	190
100	120	15	55	50	90	85	125	125	165	180	220
120	140	15	60	60	105	100	145	145	190	200	245
140	160	20	70	70	120	115	165	165	215	225	275
160	180	25	75	75	125	120	170	170	220	250	300
180	200	35	90	90	145	140	195	195	250	275	330
200	225	45	105	105	165	160	220	220	280	305	365
225	250	45	110	110	175	170	235	235	300	330	395
250	280	55	125	125	195	190	260	260	330	370	440
280	315	55	130	130	205	200	275	275	350	410	485
315	355	65	145	145	225	225	305	305	385	455	535
355	400	100	190	190	280	280	370	370	460	510	600
400	450	110	210	210	310	310	410	410	510	565	665
450	500	110	220	220	330	330	440	440	550	625	735
500	560	120	240	240	360	360	480	480	600	690	810
560	630	140	260	260	380	380	500	500	620	780	900
630	710	145	285	285	425	425	565	565	705	865	1005
710	800	150	310	310	470	470	630	630	790	975	1135
800	900	180	350	350	520	520	690	690	860	1095	1265
900	1000	200	390	390	580	580	770	770	960	960	1150
1000	1120	220	430	430	640	640	850	850	1060	1060	1270
1120	1250	230	470	470	710	710	950	950	1190	1190	1430
1250	1440	270	530	530	790	790	1050	1050	1310	1310	1570
1400	1600	330	610	610	890	890	1170	1170	1450	1450	1730

1) Radial clearance for bearings with tapered bore is selected from one group to the right, for example radial clearance CN for cylindrical bore bearings match C3 for tapered bore bearings.

SINGLE ROW, DOUBLE ROW CYLINDRICAL ROLLER BEARINGS

With Non-Interchangeable Component Parts With Cylindrical Bore

Clearance to ISO 5753-2009

Bore diameter d		Clearance group symbol											
		C1NA		C2NA		NA		C3NA		C4NA		C5NA	
mm		Radial clearance of bearing μm											
over	up to	min.	max.	min.	max.	min.	max.	min.	max.	min.	max.	min.	Max.
2,5	6	0	7	8	15	15	25	30	40	40	50		
6	10	0	7	10	20	20	30	35	45	45	55		
10	14	0	10	10	20	20	30	35	45	45	55		
14	24	5	15	10	20	20	30	35	45	45	55	65	75
24	20	5	15	10	25	25	35	40	50	50	60	70	80
30	40	5	15	12	25	25	40	45	55	55	70	80	95
40	50	5	18	15	30	30	45	50	65	65	80	95	110
50	65	5	20	15	35	35	50	55	75	75	90	110	130
65	80	10	25	20	40	40	60	70	90	90	110	130	150
80	100	10	30	25	45	45	70	80	105	105	125	155	180
100	120	10	30	25	50	50	80	95	120	120	145	180	205
120	140	10	35	30	60	60	90	105	135	135	160	200	230
140	160	10	35	35	65	65	100	115	150	150	180	225	260
160	180	10	40	35	75	75	110	125	165	165	200	250	285
180	200	15	45	40	80	80	120	140	180	180	220	275	315
200	225	15	50	45	90	90	135	155	200	200	240	305	350
225	250	15	50	50	100	100	150	170	215	215	265	330	380
250	280	20	55	55	110	110	165	185	240	240	295	370	420
280	315	20	60	60	120	120	180	205	265	265	325	410	470
315	355	20	65	65	135	135	200	225	295	295	360	455	520
355	400	25	75	75	150	150	225	255	330	330	405	510	585
400	450	25	85	85	170	170	255	285	370	370	455	565	650
450	500	25	95	95	190	190	285	315	410	410	505	625	720
500	560	25	100	105	210	210	315	350	455	455	560	720	815
560	630	30	110	115	230	230	345	390	505	505	620	800	910
630	710	30	130	130	260	260	390	435	565	565	695	900	1030
710	800	35	140	145	290	290	435	485	630	630	775	1000	1140
800	900	35	160	160	320	320	480	540	700	700	860	1130	1290
900	1000	35	180	180	360	360	540	600	780	780	960	1270	1440
1000	1120	50	200	200	400	400	600	660	880	880	1060	1380	1560
1120	1250	60	220	220	440	440	660	730	950	950	1170	1520	1720
1250	1400	60	240	240	480	480	720	810	1050	1050	1290	1680	1900
1400	1600	70	270	270	540	540	810	910	1190	1190	1460	1900	2150

1) Radial clearance for bearings with tapered bore is selected from one group to the right, for example radial clearance CN for cylindrical bore bearings match C3 for tapered bore bearings.

DOUBLE ROW SPHERICAL ROLLER BEARINGS

With Cylindrical Bore

Clearance to ISO 5753-2009

Nominal bore diameter d		Symbol of clearance group											
		C1		C2		CN		C3		C4		C5	
mm		Radial clearance of bearing μm											
over	up to	min.	max.	min.	max.	min.	max.	min.	max.	min.	max.	min.	max.
14	24	0	10	10	20	20	35	35	45	45	60	60	75
24	30	0	15	15	25	25	40	40	55	55	75	75	95
30	40	0	15	15	30	30	45	45	60	60	80	80	100
40	50	0	20	20	35	35	55	55	75	75	100	100	125
50	65	0	20	20	40	40	65	65	90	90	120	120	150
65	80	5	30	30	50	50	80	80	110	110	145	145	185
80	100	5	35	35	60	60	100	100	135	135	180	180	225
100	120	5	40	40	75	75	120	120	160	160	210	210	260
120	140	5	50	50	95	95	145	145	190	190	240	240	300
140	160	10	60	60	110	110	170	170	220	220	280	280	350
160	180	10	65	65	120	120	180	180	240	240	310	310	390
180	200	10	70	70	130	130	200	200	260	260	340	340	430
200	225	10	80	80	140	140	220	220	290	290	380	380	470
225	250	15	90	90	150	150	240	240	320	320	420	420	520
250	280	15	100	100	170	170	260	260	350	350	460	460	570
280	315	15	110	110	190	190	280	280	370	370	500	500	630
315	355	20	120	120	200	200	310	310	410	410	550	550	690
355	400	20	130	130	220	220	340	340	450	450	600	600	750
400	450	20	140	140	240	240	370	370	500	500	660	660	820
450	500	20	140	140	260	260	410	410	550	550	720	720	900
500	560	20	150	150	280	280	440	440	600	600	780	780	1000
560	630	30	170	170	310	310	480	480	650	650	850	850	1100
630	710	30	190	190	350	350	530	530	700	700	920	920	1190
710	800	30	210	210	390	390	580	580	770	770	1010	1010	1300
800	900	30	230	230	430	430	650	650	860	860	1120	1120	1440
900	1000	40	260	260	480	480	710	710	930	930	1220	1220	1570

DOUBLE ROW SPHERICAL ROLLER BEARINGS

With Tapered Bore

Clearance to ISO 5753-2009

Nominal bore diameter d		Symbol of clearance group											
		C1		C2		CN		C3		C4		C5	
mm		Radial clearance of bearing μm											
over	up to	min.	max.	min.	max.	min.	max.	min.	max.	min.	max.	min.	max.
18	24	5	15	15	25	25	35	35	45	45	60	60	75
24	30	10	20	20	30	30	40	40	55	55	75	75	95
30	40	15	25	25	35	35	50	50	65	65	85	85	105
40	50	15	30	30	45	45	60	60	80	80	100	100	130
50	65	25	40	40	55	55	75	75	95	95	120	120	160
65	80	30	50	50	70	70	95	95	120	120	150	150	200
80	100	30	55	55	80	80	110	110	140	140	180	180	230
100	120	40	65	65	100	100	135	135	170	170	220	220	280
120	140	50	80	80	120	120	160	160	200	200	260	260	330
140	160	55	90	90	130	130	180	180	230	230	300	300	380
160	180	65	100	100	140	140	200	200	260	260	340	340	430
180	200	70	110	110	160	160	220	220	290	290	370	370	470
200	225	70	120	120	180	180	250	250	320	320	410	410	520
225	250	90	140	140	200	200	270	270	350	350	450	450	570
250	280	90	150	150	220	220	300	300	390	390	490	490	620
280	315	100	170	170	240	240	330	330	430	430	540	540	680
315	355	120	190	190	270	270	360	360	470	470	590	590	740
355	400	130	210	210	300	300	400	400	520	520	650	650	820
400	450	140	230	230	330	330	440	440	570	570	720	720	910
450	500	160	260	260	370	370	490	490	630	630	790	790	1000
500	560	180	290	290	410	410	540	540	680	680	870	870	1100
560	630	200	320	320	460	460	600	600	760	760	980	980	1230
630	710	210	350	350	510	510	670	670	850	850	1090	1090	1360
710	800	230	390	390	570	570	750	750	960	960	1220	1220	1500
800	900	250	440	440	640	640	840	840	1070	1070	1370	1370	1690
900	1000	280	490	490	710	710	930	930	1190	1190	1520	1520	1860

REDUCTION OF RADIAL CLEARANCE IN TAPERED BORE OF DOUBLE ROW SPHERICAL ROLLER BEARINGS, MOUNTED ON SHAFT

Clearance to ISO 5753-2009

Nominal bore diameter d		Reduction of radial clearance		Axial displacement on 1:12 taper				Axial displacement on 1:30 taper				Check value of smallest radial clearance after mounting: clearance group		
				On the shaft		On the sleeve		On the shaft		On the sleeve				
over	up to	min.	max.	min.	max.	min.	max.	min.	max.	min.	max.	CN	C3	C4
30	40	0,02	0,025	0,35	0,4	0,35	0,45	-	-	-	-	0,015	0,025	0,04
40	50	0,025	0,03	0,4	0,45	0,45	0,5	-	-	-	-	0,02	0,03	0,05
50	65	0,03	0,04	0,45	0,6	0,5	0,7	-	-	-	-	0,025	0,035	0,055
65	80	0,04	0,05	0,6	0,75	0,7	0,85	-	-	-	-	0,025	0,04	0,07
80	100	0,045	0,06	0,7	0,9	0,75	1	1,7	2,2	1,8	2,4	0,035	0,05	0,08
100	120	0,05	0,07	0,7	1,1	0,8	1,2	1,9	2,7	2	2,8	0,05	0,065	0,1
120	140	0,065	0,09	1,1	1,4	1,2	1,5	2,7	3,5	2,8	3,6	0,055	0,08	0,11
140	160	0,075	0,1	1,2	1,6	1,3	1,7	3	4	3,1	4,2	0,055	0,09	0,13
160	180	0,08	0,11	1,3	1,7	1,4	1,9	3,2	4,2	3,3	4,6	0,06	0,1	0,15
180	200	0,09	0,13	1,4	2	1,5	2,2	3,5	4,5	3,6	5	0,07	0,1	0,16
200	225	0,1	0,14	1,6	2,2	1,7	2,4	4	5,5	4,2	5,7	0,08	0,12	0,18
225	250	0,11	0,15	1,7	2,4	1,8	2,6	4,2	6	4,6	6,2	0,09	0,13	0,2
250	280	0,12	0,17	1,9	2,6	2	2,9	4,7	6,7	4,8	6,9	0,1	0,14	0,22
280	315	0,13	0,19	2	3	2,2	3,2	5	7,5	5,2	7,7	0,11	0,15	0,24
315	355	0,15	0,21	2,4	3,4	2,6	3,6	6	8,2	6,2	8,4	0,12	0,17	0,26
355	400	0,17	0,23	2,6	3,6	2,9	3,9	6,5	9	5,8	9,2	0,13	0,19	0,29
400	450	0,2	0,26	3,1	4,1	3,4	4,4	7,7	10	8	10,4	0,13	0,2	0,31
450	500	0,21	0,28	3,3	4,4	3,6	4,8	8,2	11	8,4	11,2	0,16	0,23	0,35
500	560	0,24	0,32	3,7	5	4,1	5,4	9,2	12,5	9,6	12,8	0,17	0,25	0,36
560	630	0,26	0,35	4	5,4	4,4	5,9	10	13,5	10,4	14	0,2	0,29	0,41
630	710	0,3	0,4	4,6	6,2	5,1	6,8	11,5	15,5	12	16	0,21	0,31	0,45
710	800	0,34	0,45	5,3	7	5,8	7,6	13,3	17,5	13,6	18	0,23	0,35	0,51
800	900	0,37	0,5	5,7	7,8	6,3	8,5	14,3	19,5	14,8	20	0,27	0,39	0,57
900	1000	0,41	0,55	6,3	8,5	7	9,4	15,8	21	16,4	22	0,3	0,43	0,64
1000	1120	0,45	0,6	6,8	9	7,6	10,2	17	23	18	24	0,32	0,48	0,7
1120	1250	0,49	0,65	7,4	9,8	8,3	11	18,5	25	19,6	26	0,34	0,54	0,77
1250	1400	0,55	0,72	8,3	10,8	9,3	12,1	21	27	22,2	28,3	0,36	0,59	0,84

Dimensions in mm

RADIAL CLEARANCE OF DOUBLE AND FOUR ROW TAPERED ROLLER BEARINGS

Clearance to ISO 5753-2009

Nominal bore diameter d		Symbol of clearance group											
		C1		C2		CN		C3		C4		C5	
mm		Radial clearance of bearing μm											
over	up to	min.	max.	min.	max.	min.	max.	min.	max.	min.	max.	min.	max.
50	65	0	15	15	30	30	50	50	70	70	90	90	120
65	80	0	20	20	40	40	60	60	80	80	110	110	150
80	100	0	20	20	45	45	70	70	100	100	130	130	170
100	120	0	25	25	50	50	80	80	110	110	150	150	200
120	140	0	30	30	60	60	90	90	120	120	170	170	230
140	160	0	30	30	65	65	100	100	140	140	190	190	260
160	180	0	35	35	70	70	110	110	150	150	210	210	280
180	200	0	40	40	80	80	120	120	170	170	230	230	310
200	225	0	40	40	90	90	140	140	190	190	260	260	340
225	250	0	50	50	100	100	150	150	210	210	290	290	380
250	280	0	50	50	110	110	170	170	230	230	320	320	420
280	315	0	60	60	120	120	180	180	250	250	350	350	460
315	355	0	70	70	140	140	210	210	280	280	390	390	510
355	400	0	70	70	150	150	230	230	310	310	440	440	580
400	450	0	80	80	170	170	260	260	350	350	490	490	650
450	500	0	90	90	190	190	290	290	390	390	540	540	720
500	560	0	100	100	210	210	320	320	430	430	590	590	790
560	630	0	110	110	230	230	350	350	480	480	660	660	880
630	710	0	130	130	260	260	400	400	540	540	740	740	910
710	800	0	140	140	290	290	450	450	610	610	830	830	1100
800	900	0	160	160	330	330	500	500	670	670	920	920	1240

SHAFT AND HOUSING FITS

SHAFT TOLERANCES

1. Cylindrical bore bearings.

Type of Load	Bearing type	Diameter	Axial Movement Magnitude of Load	Tolerance field	
Rotating Outer Ring Load	Ball & Roller Bearing	All sizes	Angular contact ball bearing and tapered roller bearing adjustment via inner ring	g6 h6 h6	(g5) (h5) (j6)
Rotating Inner Ring or indeterminate Load	Ball Bearing	Up to 40mm	normal load	J6	(j5)
		Up to 100mm	low load normal & high load	J6 k6	(j5) (k5)
		Up to 200mm	low load normal & high load	K6 m6	(k5) (m5)
		Over 200mm	normal load high load, shock load	M6 n6	(m5) (n5)
	Roller Bearing	Up to 60mm	low load normal & high load	J6 k6	(j5) (k5)
		Up to 200mm	low load normal load high load	K6 m6 n6	(k5) (m5) (n5)
		Up to 500mm	normal load high load, shock load	m6 p6	(m5)
		Over 500mm	normal load high load	N6 p6	(n5)

SHAFT TOLERANCES

2. Thrust bearings

Type of Load	Bearing type	Diameter	Operating conditions	Tolerance field	
Thrust load	thrust ball bearings	all sizes		J6	
	trust ball bearings double acting	all sizes		J6	(k6)
	cylindrical roller thrust bearing	all sizes		h6	(j6)
	trust cylindrical roller & cage assembly	all sizes		h10	
	thrust cylindrical roller & cage assembly or thrust needle roller & cage assembly	all sizes		h8	
Combined Load	spherical roller thrust bearing	all sizes	point load on shaft washer	j6	
		up to 200mm	circumferential	j6	(k6)
		over 200 mm	load on shaft washer	k6	(m6)

ADAPTER SLEEVES, WITHDRAWAL SLEEVES

Permissible geometrical inaccuracy (out-of-roundness taper)		Tolerance field
Adapter sleeves and withdrawal sleeves	IT 5/2	H7
	IT 5/2	h8
	IT 6/2	h9

SHAFT TOLERANCES FOR ADAPTER SLEEVES AND WITHDRAWAL SLEEVES

Tolerances in μm

d mm		H7		$\frac{IT\ 5}{2}$	h8		$\frac{IT\ 5}{2}$	h9		$\frac{IT\ 6}{2}$
over	up to	upper	lower	max.	upper	lower	max.	upper	lower	max.
0	0	0	0	0	0	0	0	0	0	0
6	10	0	-15	3	0	-22	3	0	-36	4.5
10	18	0	-18	4	0	-27	4	0	-43	5.5
18	30	0	-21	4.5	0	-39	4.5	0	-52	6.5
30	50	0	-25	5.5	0	-39	5.5	0	-62	8
50	80	0	-30	6.5	0	-46	6.5	0	-74	9.5
80	120	0	-35	7.5	0	-54	7.5	0	-87	11
120	180	0	-40	9	0	-63	9	0	-100	12.5
180	250	0	-46	10	0	-72	10	0	-115	14.5
250	315	0	-52	11.5	0	-81	11.5	0	-130	16
315	400	0	-57	12.5	0	-89	12.5	0	-140	18
400	500	0	-63	13.5	0	-97	13.5	0	-155	20

Note: IT basic tolerances indicate accepted from circularity and cylindricity

HOUSING TOLERANCES

1. Radial bearing

Type of Load	Axial Movement Magnitude of Load	Operation Conditions	Tolerance field	
Rotating inner Ring Load	Outer Ring slides in Housing	closeness of tolerance function of running accuracy	H7	(H6)
		high running accuracy	H7	(J6)
		standard running accuracy	H7	(J6)
		temperature increase through shaft	G7	
Rotating Outer Ring Load or indeterminate load	low load	with high running accuracy requirements K6,M6,N6 and P6	K7	(KJ6)
	normal load, shock load		M7	(M6)
	high load, shock load		N7	(N6)
	high load, heavy shock load thin-walled housings		P7	(P6)

HOUSING TOLERANCES

2. Thrust Bearing

Type of load	Bearing type	Operating conditions	Tolerance field	
Thrust load	thrust ball bearings	standard running accuracy	E8	(K6)
		high running accuracy	E6	
	cylindrical roller thrust bearing	H7		
	thrust cylindrical roller & cage assembly	H11		
	thrust cylindrical roller & cage assembly	H10		
	spherical roller thrust bearing	normal load	E8	
		high load	G7	
Radial & axial loads on spherical roller thrust bearings	stationary load on housing washer		H7	
	rotating load on housing washer		M7	

FITS

Tolerances for the boundary dimensions of bearings are to ISO standards. To ensure satisfactory performance of the bearing under variable operating conditions, it is necessary to select suitable fits between the inner ring and the shaft and the outer ring and the housing.

When selecting the correct fits from the ISO range of shaft and housing tolerances, it is necessary to consider adequate radial support of the bearing, ease of mounting and dismounting, and allowance for axial movement of the free bearing.

Selection of the fit also depends on the loading on the bearing and on the operating temperature. It should be noted that tight fits reduce the internal clearance of the bearing, and allowance should be made when selecting the bearing clearance.

TOLERANCES

The boundary dimensions and tolerances of rolling bearings have been standardized by ISO. Bearings are manufactured to normal class 0 tolerances, unless otherwise stated.

Tolerances are also listed for the closer-than-normal limits required, for example, in machine tool and high speed applications.

The more common ISO norms referred to are as follows:

- ISO 15-2008 – Rolling bearings – Radial bearings – Boundary dimensions
- ISO 104-2002 – Thrust bearings with flat housing washers – Boundary dimensions
- ISO 199-2005 – Rolling bearings – Thrust ball bearings – Tolerances
- ISO 355-2007 – Metric tapered roller bearing - Boundary dimensions
- ISO 464-2002 – Rolling bearings with locating snap ring – Dimensions
- ISO 492-2002 – Radial bearings – Tolerances
- ISO 1132-2001 – Rolling bearings – Tolerances – Definitions
- ISO 5753-2009 – Rolling bearings – Radial internal clearances

Mounting Data

Deviation of shaft diameters 0.001mm

Nominal diameter		g5		g6		h5		h6		h8		h10		j5	
over	inc	Max	Min	Max	Min	Max	Min	Max	Min	Max	Min	Max	Min	Max	Min
3	6	-4	-9	-4	-12	0	-5	0	-8	0	-18	0	-48	+3	-2
6	10	-5	-11	-5	-14	0	-6	0	-9	0	-22	0	-58	+4	-2
10	18	-6	-4	-6	-17	0	-8	0	-11	0	-27	0	-70	+5	-3
18	30	-7	-16	-7	-20	0	-9	0	-13	0	-33	0	-84	+5	-4
30	50	-9	-20	-9	-25	0	-11	0	-16	0	-39	0	-100	+6	-5
50	80	-10	-23	-10	-29	0	-13	0	-19	0	-46	0	-120	+6	-7
80	120	-12	-27	-12	-34	0	-15	0	-22	0	-54	0	-140	+6	-9
120	180	-14	-32	-14	-39	0	-18	0	-25	0	-63	0	-160	+7	-11
180	250	-15	-35	-15	-44	0	-20	0	-29	0	-72	0	-185	+7	-13
250	315	-17	-40	-17	-49	0	-23	0	-32	0	-81	0	-210	+7	-16
316	400	-18	-43	-18	-54	0	-25	0	-36	0	-89	0	-230	+7	-18
400	500	-20	-47	-20	-60	0	-27	0	-40	0	-97	0	-250	+7	-20

Mounting Data

Deviation of housing diameters 0.001mm

Nominal diameter		E8		G6		G7		H6		H7		H10		H11		J6	
over	inc	Max	Min	Max	Min	Max	Min	Max	Min	Max	Min	Max	Min	Max	Min	Max	Min
6	10	+47	+25	+14	+5	+20	+5	+9	0	+15	0	+58	0	+90	0	+5	-4
10	18	+59	+32	+17	+6	+24	+6	+11	0	+18	0	+70	0	+110	0	+6	-5
18	30	+73	+40	+20	+7	+28	+7	+13	0	+21	0	+84	0	+130	0	+8	-5
30	50	+89	+50	+25	+9	+34	+9	+16	0	+25	0	+100	0	+160	0	+10	-6
50	80	+106	+60	+29	+10	+40	+10	+19	0	+30	0	+120	0	+190	0	+13	-6
80	120	+126	+72	+34	+12	+47	+12	+22	0	+35	0	+140	0	+220	0	+16	-6
120	180	+148	+85	+39	+14	+54	+14	+25	0	+40	0	+160	0	+250	0	+18	-7
180	250	+172	+100	+44	+15	+61	+15	+29	0	+46	0	+185	0	+290	0	+22	-7
250	315	+191	+110	+49	+17	+69	+17	+32	0	+52	0	+210	0	+320	0	+25	-7
315	400	+214	+125	+54	+18	+75	+18	+36	0	+57	0	+230	0	+360	0	+29	-7
400	500	+232	+135	+60	+20	+83	+20	+40	0	+63	0	+250	0	+400	0	+33	-7

Deviation Of Shaft Diameters 0.001 mm

Nominal diameter		j6		k5		k6		m5		m6		n5		n6		p6	
over	inc	Max	Min	Max	Min	Max	Min	Max	Min	Max	Min	Max	Min	Max	Min	Max	Min
3	6	+6	-2	+6	+1	+9	+1	+9	+4	+12	+4	+13	+8	+16	+8	+20	+12
6	10	+7	-2	+7	+1	+10	+1	+12	+6	+15	+6	+16	+10	+19	+10	+24	+15
10	18	+8	-3	+9	+	+12	+1	+15	+7	+18	+7	+20	+12	+23	+12	+29	+18
18	30	+9	-4	+11	+2	+15	+2	+17	+8	+21	+8	+24	+15	+28	+15	+35	+22
30	50	+11	-5	+13	+2	+18	+2	+20	+9	+25	+9	+28	+17	+33	+17	+42	+26
50	80	+12	-7	+15	+2	+21	+2	+24	+11	+30	+11	+33	+20	+39	+20	+51	+32
80	120	+13	-9	+18	+3	+25	+3	+28	+13	+35	+13	+38	+23	+45	+23	+59	+37
120	180	+14	-11	+21	+3	+28	+3	+33	+15	+40	+15	+45	+27	+52	+27	+66	+43
180	250	+16	-13	+24	+4	+33	+4	+37	+17	+46	+17	+51	+31	+60	+31	+79	+50
250	315	+16	-16	+27	+4	+36	+4	+43	+20	+52	+20	+57	+34	+66	+34	+88	+56
316	400	+18	-18	+29	+4	+40	+4	+46	+21	+57	+21	+62	+37	+73	+37	+98	+62
400	500	+20	-20	+32	+5	+45	+5	+50	+23	+63	+23	+67	+40	+80	+40	+108	+68

Deviation Of Housing Diameters 0.001 mm

Nominal diameter		J7		K6		K7		M6		M7		N6		N7		P6		P5	
over	inc	Max	Min	Max	Min	Max	Min	Max	Min	Max	Min	Max	Min	Max	Min	Max	Min	Max	Min
6	10	+8	-7	+2	-7	+5	-10	-3	-12	0	-15	-7	-16	-4	-19	-12	-21	-9	-24
10	18	+10	-8	+2	-9	+6	-12	-4	-15	0	-18	-9	-20	-5	-23	-15	-26	-11	-29
18	30	+12	-9	+2	-11	+6	-15	-4	-17	0	-21	-11	-24	-7	-28	-18	-31	-14	-35
30	50	+14	-11	+3	-13	+7	-18	-4	-20	0	-25	-12	-28	-8	-33	-21	-37	-17	-42
50	80	+18	-12	+4	-15	+9	-21	-5	-24	0	-30	-14	-33	-9	-39	-26	-45	-21	-48
80	120	+22	-13	+4	-18	+10	-25	-6	-28	0	-35	-16	-38	-10	-45	-30	-52	-24	-59
120	180	+26	-14	+4	-21	+12	-28	-8	-33	0	-40	-20	-45	-12	-52	-36	-61	-28	-68
180	250	+30	-16	+5	-24	+13	-33	-8	-37	0	-46	-22	-51	-14	-60	-41	-70	-33	-79
250	315	+36	-16	+5	-27	+16	-36	-9	-41	0	-52	-25	-57	-14	-66	-47	-79	-36	-88
315	400	+39	-18	+7	-29	+17	-40	-10	-46	0	-57	-26	-62	-16	-73	-51	-87	-41	-98
400	500	+43	-20	+8	-32	+18	-45	-10	-50	0	-63	-27	-67	-17	-80	-55	-95	-45	-108

SHAFT AND HOUSING MACHINING TOLERANCES

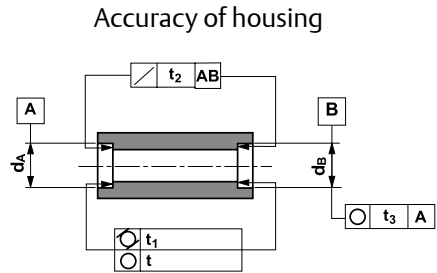
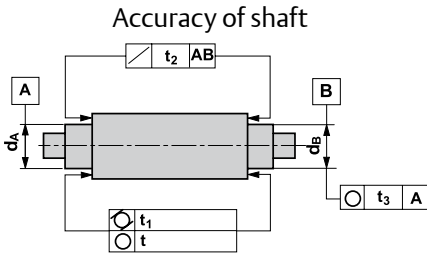

Description	Fit	Symbol of tolerance	Allowable tolerances depending on precision classes					
			P0	P6	P5	P4(SP)	P2(UP)	
Dimensional accuracy	shaft	--	IT 6	IT 5	IT 4	IT 4	IT 3	
	housing		IT 7	IT 6	IT 5	IT 5	IT 4	
Roundness	shaft	○	t_1	IT 4	IT 3	IT 2	IT 1	IT 0
	housing			IT 5	IT 4	IT 3	IT 2	IT 1
Cylindricity	shaft	⊂	t_2	IT 3	IT 3	IT 2	IT 1	IT 0
	housing			IT 4	IT 3	IT 3	IT 2	IT 1
Runout	shaft	↗	t_3	IT 3	IT 3	IT 2	IT 1	IT 0
	housing			IT 4	IT 3	IT 2	IT 2	IT 1
Eccentricity	shaft	⊙	t_c	IT 5	IT 4	IT 4	IT 3	IT 3
	housing			IT 6	IT 5	IT 5	IT 4	IT 3

BASIC TOLERANCE RANGE ISO-IT

d; D		IT 0	IT 1	IT 2	IT 3	IT 4	IT 5	IT 6	IT 7	IT 8
from	to									
mm		μm								
1	3	0.5	0.8	1.2	2	2	4	6	10	14
3	6	0.6	1	1.5	2.5	4	5	8	12	18
6	10	0.6	1	1.5	2.5	4	6	9	15	22
10	18	0.8	1.2	2	3	5	8	11	18	27
18	30	1	1.5	2.5	4	6	9	13	21	33
30	50	1	1.5	2.5	4	7	11	16	25	39
50	80	1.2	2	3	5	8	13	19	30	46
80	120	1.5	2.5	4	6	10	15	22	35	54
120	180	2	3.5	5	8	12	18	25	40	63
180	250	3	4.5	7	10	14	20	28	46	72
250	315	4	6	8	12	16	23	32	52	81
315	400	5	7	9	13	18	25	36	57	89
400	500	6	8	10	15	20	27	40	63	97

ROLLING BEARING TOLERANCE SYMBOLS

Bore Diameter

- d - Nominal bore diameter
- d_1 - Nominal large diameter of tapered bore
- d_s - Single bore diameter
- Δd_s - Deviation of a single bore diameter
- $\sqrt{d_s}$ - Bore diameter variation
- D_m - Mean bore diameter
- Δd_m - Mean bore diameter deviation
- D_{mp} - Single plane mean bore diameter
- Δd_{mp} - Single plane mean bore diameter deviation
- Δd_{1mp} - Deviation of mean large diameter from nominal-tapered bore
- V_{DP} - Bore diameter variation in a single radial plane
- V_{DMP} - Mean bore diameter variation
- α - Taper angle

Outside Diameter

- D - Nominal outside diameter
- D_s - Single outside diameter
- $\sqrt{D_s}$ - Deviation of a single outside diameter
- D_m - Mean outside diameter
- ΔD_m - Mean outside diameter deviation
- D_{mp} - Single plane mean outside diameter
- ΔD_{mp} - Single plane outside diameter deviation
- V_{DP} - Outside diameter variation in a single radial plane
- V_{DMP} - Mean outside diameter variation

Width And Height

- B - Nominal inner ring width
- V - Nominal outer ring width
- Bs - Single inner ring width
- Cs - Single outer ring width
- ΔBs - Deviation of a single inner ring width
- ΔCs - Deviation of a single outer ring width
- \sqrt{Bs} - inner ring width variation
- \sqrt{Cs} - Outer ring width variation
- Bm - Mean inner ring width

Radial Run Out

- Kla - Radial run out of assembled bearing inner ring
- Kea - Radial run out of assembled bearing outer ring
- Sd - Face run out with bore
- SD - Variation of outside surface inclination with face
- Sla - Assembled bearing inner ring face run out with raceway
- Sea - Assembled bearing outer ring face run out with raceway

- D1 - Nominal diameter of outer ring flange
- T - Nominal width of tapered roller bearing
- ΔTs - Deviation in width of tapered roller bearing at single position
- T1 - Nominal width of tapered roller bearing-cone
- $\Delta T1s$ - Deviation of width of tapered roller bearing-cone
- T2 - Nominal width of tapered roller bearing-cup
- $\Delta T2s$ - Deviation of width of tapered roller bearing-cup

- d2 - Nominal shaft washer diameter – double acting thrust bearing
- $\Delta d2p$ - Deviation of shaft washer mean bore diameter single plane

- Dw - Nominal diameter of roller
- Dwm - Mean diameter of roller
- Lw - Nominal length of roller

TOLERANCES RADIAL BEARINGS (EXCEPT TAPERED ROLLER BEARINGS)

PRECISION CLASS P0 Tolerances in μm **Inner ring**

d mm		Δdmp		V dp Diameter ranges			Vdmp	Kia	ΔBs				V_{Bs}
				7,8,9	0,1	2,3,4			Modified ²				
over	up to	upper	lower	max.			max.	max.	upper	lower	upper	lower	max.
0,6 ¹⁾	2,5	0	-8	10	8	6	6	10	0	-40	-	-	12
2,5	10	0	-8	10	8	6	6	10	0	-120	0	-250	15
10	18	0	-8	10	8	6	6	10	0	-120	0	-250	20
18	30	0	-10	13	10	8	8	13	0	-120	0	-250	20
30	50	0	-12	15	12	9	9	15	0	-120	0	-250	20
50	80	0	-15	19	19	11	11	20	0	-150	0	-380	25
80	120	0	-20	25	25	15	15	25	0	-200	0	-380	25
120	180	0	-25	31	31	19	19	30	0	-250	0	-500	30
180	250	0	-30	38	38	23	23	40	0	-300	0	-500	30
250	315	0	-35	44	44	26	26	50	0	-350	0	-500	35
315	400	0	-40	50	50	30	30	60	0	-400	0	-500	40
400	500	0	-45	56	56	34	34	65	0	-450	0	-630	50
500	630	0	-50	63	63	38	38	70	0	-500	-	-	60
630	800	0	-75	-	-	-	-	80	0	-750	-	-	70
800	1000	0	-100	-	-	-	-	90	0	-1000	-	-	80
1000	1250	0	-125	-	-	-	-	100	0	-1250	-	-	100
1250	1600	0	-160	-	-	-	-	120	0	-1600	-	-	120
1600	2000	0	-200	-	-	-	-	140	0	-2000	-	-	140

1) Including this dimension

2) Only for bearings mounted in sets

Tolerances in μm **Outer ring**

D mm		ΔDmp		VDp ² Open Bearings Diameter ranges			Sealed bearings 2,3,4	VDmp ²	Kea	ΔCs	VCs
				7,8,9	0,1	2,3,4					
over	up to	upper	lower	max.			max.	max.			
2,5 ¹⁾	6	0	-8	10	8	6	10	6	10	Identical with ΔBs and $V\text{Bs}$ of the inner ring of the same bearing	
6	18	0	-8	10	8	6	10	6	10		
18	30	0	-9	12	9	7	12	6	10		
30	50	0	-11	14	11	8	16	8	13		
50	80	0	-13	16	13	10	20	9	15		
80	120	0	-15	19	19	11	26	11	20		
120	150	0	-18	23	23	14	30	15	25		
150	180	0	-25	31	31	19	38	19	30		
180	250	0	-30	38	38	23	-	23	40		
250	315	0	-35	44	44	26	-	26	50		
315	400	0	-40	50	50	30	-	30	60		
400	500	0	-45	56	56	34	-	34	65		
500	630	0	-50	63	63	38	-	38	70		
630	800	0	-75	94	94	55	-	-	80		
800	1000	0	-100	125	125	75	-	-	90		
1000	1250	0	-125	-	-	-	-	-	100		
1250	1600	0	-160	-	-	-	-	-	120		
1600	2000	0	-200	-	-	-	-	-	-		
2000	2500	0	-250	-	-	-	-	-	140		

1) Including this dimension

2) Mean diameter variation before fitting snap rings

TOLERANCES RADIAL BEARINGS (EXCEPT TAPERED ROLLER BEARINGS)

PRECISION CLASS P6 Tolerances in μm Inner ring

D mm		Δdmp		Vdp Diameter ranges			Vdmp	Kia	ΔBs				VBs
				7,8,9	0,1	2,3,4			modified ²⁾				
over	up to	upper	lower	max.			max.	max.	upper	lower	upper	lower	max.
0,6 ¹⁾	2,5	0	-7	9	7	5	5	5	0	-40	-	-	12
2,5	10	0	-7	9	7	5	5	6	0	-120	0	-250	15
10	18	0	-7	9	7	5	5	7	0	-120	0	-250	20
18	30	0	-8	10	8	6	6	8	0	-120	0	-250	20
30	50	0	-10	13	10	8	8	10	0	-120	0	-250	20
50	80	0	-12	15	15	9	9	10	0	-150	0	-380	25
80	120	0	-15	19	19	11	11	13	0	-200	0	-380	25
120	180	0	-18	23	23	14	14	18	0	-250	0	-500	30
180	250	0	-22	28	28	17	17	20	0	-300	0	-500	30
250	315	0	-25	31	31	19	19	25	0	-350	0	-500	35
315	400	0	-30	38	38	23	23	30	0	-400	0	-630	40
400	500	0	-35	44	44	26	26	35	0	-450	-	-	50
500	630	0	-40	50	50	30	30	40	0	-500	-	-	60

1) Including this dimension

2) Only for bearings mounted in sets

Tolerances in μm Outer ring

D mm		$\Delta\text{Dm p}$		VDp ²⁾ Open Bearings Diameter ranges			Sealed bearings VDmp ²⁾	Kea	ΔCs	vCs
				7,8,9	0,1	2,3,4				
over	up to	upper	lower	max.			max.	max.		
2,5 ¹⁾	6	0	-7	9	7	5	9	5	8	Identical with ΔBs and VBs of the inner ring of the same bearing
6	18	0	-7	9	7	5	9	5	8	
18	30	0	-8	10	8	6	10	6	9	
30	50	0	-9	11	9	7	13	7	10	
50	80	0	-11	14	11	8	16	8	13	
80	120	0	-13	16	16	10	20	10	18	
120	150	0	-15	19	19	11	25	11	20	
150	180	0	-18	23	23	14	30	14	23	
180	250	0	-20	25	25	15	-	15	25	
250	315	0	-25	31	31	19	-	19	30	
315	400	0	-28	35	35	21	-	21	35	
400	500	0	-33	41	41	25	-	25	40	
500	630	0	-38	48	48	29	-	29	50	
630	800	0	-45	56	56	34	-	34	60	
800	1000	0	-60	75	75	45	-	45	75	

TOLERANCES RADIAL BEARINGS (EXCEPT TAPERED ROLLER BEARINGS)

PRECISION CLASS P2

Tolerances in μm Inner ring

d mm		Δdmp		Δds		Vdp	Vdmp	Kia	Sd	Sia2	ΔBs		Vbs
over	up to	upper	lower	upper	lower	max.	max.	max.	max.	max.	upper	lower	max.
0,6 ¹⁾	2,5	0	-2,5	0	-2,5	2,5	1,5	1,5	1,5	1,5	0	-40	1,5
2,5	10	0	-2,5	0	-2,5	2,5	1,5	1,5	1,5	1,5	0	-40	1,5
10	18	0	-2,5	0	-2,5	2,5	1,5	1,5	1,5	1,5	0	-80	1,5
18	30	0	-2,5	0	-2,5	2,5	1,5	2,5	1,5	2,5	0	-120	1,5
30	50	0	-2,5	0	-2,5	2,5	1,5	2,5	1,5	2,5	0	-120	1,5
50	80	0	-4	0	-4	4	2	2,5	1,5	2,5	0	-150	1,5
80	120	0	-5	0	-5	5	2,5	2,5	2,5	2,5	0	-200	2,5
120	150	0	-7	0	-7	7	3,5	2,5	2,5	2,5	0	-250	2,5
150	180	0	-7	0	-7	7	3,5	5	4	5	0	-300	4
180	250	0	-8	0	-8	8	4	5	5	5	0	-350	5

- 1) Including this dimension
- 2) Only for deep groove ball bearings

Tolerances in μm Outer ring

D mm		ΔDmp		ΔDs		$\text{VDp}^{2)}$	VDmp	Kea	SD	Sea ³⁾	ΔCs	VCs
over	up to	upper	lower	upper	lower	max.	max.	max.	max.			max.
2,5 ¹⁾	6	0	-2,5	0	-2,5	2,5	1,5	1,5	1,5	1,5		1,5
6	18	0	-2,5	0	-2,5	2,5	1,5	1,5	1,5	1,5		1,5
18	30	0	-4	0	-4	4	2	2,5	1,5	2,5		1,5
30	50	0	-4	0	-4	4	2	2,5	1,5	2,5		1,5
50	80	0	-4	0	-4	4	2	4	1,5	4		1,5
80	120	0	-5	0	-5	5	2,5	5	2,5	5		2,5
120	150	0	-5	0	-5	5	2,5	5	2,5	5		2,5
150	180	0	-7	0	-7	7	3,5	5	2,5	5		2,5
180	250	0	-8	0	-8	8	4	7	4	7		4
250	315	0	-8	0	-8	8	4	7	5	7		5
315	400	0	-10	0	-10	10	5	8	7	8		7

- 1) Including this dimension
- 2) Not valid for sealed or shielded bearings
- 3) Only for deep groove ball bearings

TOLERANCES RADIAL BEARINGS

Tolerances For Tapered Bores – Taper 1:12

Nominal dimensions

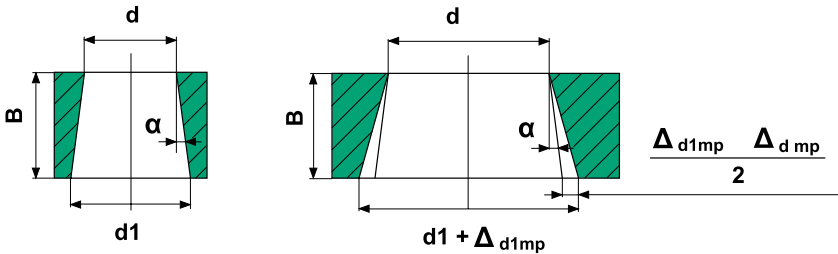

$\alpha = 2^{\circ}23'9,4'' = 2.38594^{\circ} = 0.041643 \text{ rad}$
 half the angle of taper

PRECISION CLASS P0

Tolerances in μm

D mm		$\Delta d_{mp}^{1)}$		$\Delta d_{1mp} - \Delta d_{mp}^{2)}$		$\nu d_p^{3)}$
over	to	upper	lower	upper	lower	max.
-	10	+15	0	+15	0	10
10	18	+18	0	+18	0	10
18	30	+21	0	+21	0	13
30	50	+25	0	+25	0	15
50	80	+30	0	+30	0	19
80	120	+35	0	+35	0	25
120	180	+40	0	+40	0	31
180	250	+46	0	+46	0	38
250	315	+52	0	+52	0	44
315	400	+57	0	+57	0	50
400	500	+63	0	+63	0	56

- 1) Single plane mean bore diameter deviation at smallest theoretical opening.
- 2) Mean diameter deviation of large diameter less mean diameter deviation from small diameter
- 3) Bore diameter variation in a single radial plane

TAPERED ROLLER BEARINGS

PRECISION CLASS P0

Inner Ring

Tolerances in μm

D mm		ΔD_{mp}		\sqrt{dp}	\sqrt{dmp}	Kia
over	up to	upper	lower	max.	max.	max.
10	18	0	-12	12	9	15
18	30	0	-12	12	9	18
30	50	0	-12	12	9	20
50	80	0	-15	15	11	25
80	120	0	-20	20	15	30
120	180	0	-25	25	19	35
180	250	0	-30	30	23	50
250	315	0	-35	35	26	60
315	400	0	-40	40	30	70

Outer Ring

Tolerances in μm

D mm		ΔD_{mp}		\sqrt{Dp}	\sqrt{Dmp}	Kea
over	up to	upper	lower	max.	max.	max.
18	30	0	-12	12	9	18
30	50	0	-14	14	11	20
50	80	0	-16	16	12	25
80	120	0	-18	18	14	35
120	150	0	-20	20	15	40
150	180	0	-25	25	19	45
180	250	0	-30	30	23	50
250	315	0	-35	35	26	60
315	400	0	-40	40	30	70
400	500	0	-45	45	34	80
500	630	0	-50	50	38	100

NOTE: the limit tolerance of the outer diameter D_1 of a flanged bearing is h9

TAPERED ROLLER BEARINGS

PRECISION CLASS P5

Inner Ring

Tolerances in μm

D mm		Δdmp		V_{DP}	V_{DMP}	K_{ia}	S_{d}	ΔBs		ΔTs	
over	up to	upper	lower	max.	max.	max.	max.	upper	lower	upper	lower
10	18	0	-7	5	5	5	7	0	-200	+200	-200
18	30	0	-8	6	5	5	8	0	-200	+200	-200
30	50	0	-10	8	5	6	8	0	-240	+200	-200
50	80	0	-12	9	6	7	8	0	-300	+200	-200
80	120	0	-15	11	8	8	9	0	-400	+200	-200
120	180	0	-18	14	9	11	10	0	-500	+350	-250
180	250	0	-22	17	11	13	11	0	-600	+350	-250

Outer Ring

Tolerances in μm

D mm		ΔDmp		V_{DP}	V_{DMP}	K_{ea}	S_{D}	ΔCs
over	up to	upper	lower	max.	max.	max.	max.	
18	30	0	-8	6	5	6	8	Identical with ΔBs of the inner ring of the same bearing
30	50	0	-9	7	5	7	8	
50	80	0	-11	8	6	8	8	
80	120	0	-13	10	7	10	9	
120	150	0	-15	11	8	11	10	
150	180	0	-18	14	9	13	10	
180	250	0	-20	15	10	15	11	
250	315	0	-25	19	13	18	13	
315	400	0	-28	22	14	20	13	

The limit tolerance of the outer diameter D_1 of a flanged bearing is h9

TAPERED ROLLER BEARINGS

PRECISION CLASS P4 Inner Ring

Tolerances in μm

D mm		$\Delta\text{dmp, ds}$		V_{DP}	V_{DMP}	K_{ia}	S_{d}	S_{ia}	ΔBs		ΔTs	
over	up to	upper	lower	max.	max.	max.	max.	max.	upper	lower	upper	lower
10	18	0	-5	4	4	3	3	3	0	-200	+200	-200
18	30	0	-6	5	4	3	4	4	0	-200	+200	-200
30	50	0	-8	6	5	4	4	4	0	-240	+200	-200
50	80	0	-9	7	5	4	4	4	0	-300	+200	-200
80	120	0	-10	8	5	5	5	5	0	-400	+200	-200
120	180	0	-13	10	7	6	7	7	0	-500	+350	-250
180	250	0	-15	11	8	8	8	8	0	-600	+350	-250

Outer Ring

Tolerances in μm

D mm		$\Delta\text{Dmp, } \Delta\text{Ds}$		V_{DP}	V_{DMP}	K_{ea}	S_{D}	S_{ea}	ΔCs
over	up to	upper	lower	max.	max.	max.	mas.	max.	Upper / lower
18	30	0	-6	5	4	4	4	5	Identical with ΔBs of the inner ring of the same bearing
30	50	0	-7	5	5	5	4	5	
50	80	0	-9	7	5	5	4	5	
80	120	0	-10	8	5	6	5	6	
120	150	0	-11	8	6	7	5	7	
150	180	0	-13	10	7	8	5	8	
180	250	0	-15	11	8	10	7	10	
250	315	0	-18	14	9	11	8	10	
315	400	0	-20	15	10	13	10	13	

The limit tolerance of the outer diameter D1 of a flanged bearing is h9.

TAPERED ROLLER BEARINGS

Width Of Inner And Outer Ring And Mounting Height

Tolerances in μm

D mm		$\Delta\text{BS}, \Delta\text{CS}$		ΔTS		ΔT1S		ΔT2S	
over	up to	upper	lower	upper	lower	upper	lower	upper	lower
10	18	0	-120	+120	0	+100	0	+100	0
18	30	0	-120	+200	0	+100	0	+100	0
30	50	0	-120	+200	0	+100	0	+100	0
50	80	0	-150	+200	0	+100	0	+100	0
80	120	0	-200	+200	-200	+100	-100	+100	-100
120	180	0	-250	+350	-250	+150	-150	+200	-100
180	250	0	-300	+350	-250	+150	-150	+200	-100
250	315	0	-350	+350	-250	+150	-150	+200	-100
315	400	0	-400	+400	-400	+200	-200	+200	-200

Precision Class P6X

- The limit tolerances for the diameter and the radial run-out of the outer ring and the inner ring in this precision class are the same with precision class P0.
- The limit tolerance for the width and mounting height for the outer and inner ring are those indicated below.

Tolerances in μm

D mm		ΔBs		ΔCs		ΔTs		ΔT1s		ΔT2s	
over	up to	upper	lower	upper	lower	upper	lower	upper	lower	upper	lower
10	18	0	-50	0	-100	+100	0	+50	0	+50	0
18	30	0	-50	0	-100	+100	0	+50	0	+50	0
30	50	0	-50	0	-100	+100	0	+50	0	+50	0
50	80	0	-50	0	-100	+100	0	+50	0	+50	0
80	120	0	-50	0	-100	+100	0	+50	0	+50	0
120	180	0	-50	0	-100	+150	0	+50	0	+100	0
180	250	0	-50	0	-100	+150	0	+50	0	+100	0
250	315	0	-50	0	-100	+200	0	+100	0	+100	0
315	400	0	-50	0	-100	+200	0	+100	0	+100	0

LIMIT TOLERANCES FOR TAPERED ROLLER BEARINGS WITH DIMENSIONS GIVEN IN MM AND INCHES (AFBMA)

Inner Ring

Tolerances in μm

d mm		Precision classes									
		4		2		3		0		00	
over	up to	upper	lower	upper	lower	upper	lower	upper	lower	upper	lower
-	76.2	+13	0	+13	0	+13	0	+13	0	+8	0
76.2	304.2	+25	0	+25	0	+13	0	+13	0	+8	0
304.2	609.6	+51	0	+51	0	+25	0	-	-	-	-
609.6	914.4	+76	0	-	-	+38	0	-	-	-	-
914.4	1219.2	+102	0	-	-	+51	0	-	-	-	-
1219.2	-	+127	0	-	-	+76	0	-	-	-	-

Outer Ring

Tolerances in μm

D mm		Precision classes									
		4		2		3		0		00	
over	up to	upper	lower	upper	lower	upper	lower	upper	lower	upper	lower
-	304.8	+25	0	+25	0	+13	0	+13	0	+8	0
304.8	609.6	+51	0	+51	0	+25	0	-	-	-	-
609.6	912.4	+76	0	+76	0	+38	0	-	-	-	-
914.4	1219.2	+102	0	-	-	+51	0	-	-	-	-
1219.2	-	+127	0	-	-	+76	0	-	-	-	-

RADIAL RUN-OUT OF AN ASSEMBLED BEARING

Tolerances in μm

D mm		Precision classes				
		4	2	3	0	00
over	up to	max.	max.	max.	max.	max.
-	304.8	51	38	8	4	2
304.8	609.6	51	38	18	-	-
609.6	914.4	76	51	51	-	-
914.4	-	76	-	76	-	-

TOLERANCES FOR MOUNTING HEIGHT (ΔT_S)

Tolerances in μm

D mm		D mm		Precision classes									
				4		2		3		0		00	
over	up to	over	up to	upper	lower	upper	lower	upper	lower	upper	lower	upper	lower
-	101.6			+203	0	+203	0	+203	-203	+203	-203	+203	-203
101.6	304.8			+356	-254	+203	0	+203	-203	+203	-203	+203	-203
304.8	609.6	-	508.0	+318	-381	+381	-381	+203	-203	-	-	-	-
304.8	609.6	508.0		+318	-381	+318	-381	+381	-381	-	-	-	-
609.6	-			+318	-381	-	-	+381	-381	-	-	-	-

TOLERANCES FOR THE MOUNTING HEIGHT OF THE INNER RING – ROLLER SUBASSEMBLY WITH OUTER RING (ΔT_{1S})

Tolerances in μm

d mm		D mm		Precision classes									
				4		2		3		0		00	
over	up to	over	up to	upper	lower	upper	lower	upper	lower	upper	lower	upper	lower
-	101.6			+102	0	+102	0	+102	-102	+102	-102	+102	-102
101.6	304.8			+152	-152	+102	0	+102	-102	+102	-102	+102	-102
304.8	609.6		508.0	+178	-178	+178	-178	+102	-102	-	-	-	-
304.8	609.6	508.0	-	+178	-178	+178	-178	+178	-178	-	-	-	-
609.6	-			+178	-178	-	-	+178	-178	-	-	-	-

TOLERANCES FOR THE MOUNTING OF THE OUTER RING IN THE STANDARD INNER RING SUBASSEMBLY (T_{2S})

Tolerances in μm

d mm		D mm		Precision classes									
				4		2		3		0		00	
over	up to	over	up to	upper	lower	upper	lower	upper	lower	upper	lower	upper	lower
-	101.6			+102	0	+102	0	+102	-102	+102	-102	+102	-102
101.6	304.8			+203	-102	+102	0	+102	-102	+102	-102	+102	-102
304.8	609.6		508.0	+203	-203	+203	-203	+102	-102	-	-	-	-
304.8	609.6	508.0	-	+203	-203	+203	-203	+203	-203	-	-	-	-
609.6	-			+203	-203	-	-	+203	-203	-	-	-	-

DOUBLE ROW CYLINDRICAL ROLLER BEARING

PRECISION CLASS SP

Inner Ring

Tolerances in μm

D mm		cylindrical bore			Δds		tapered bore				ΔBs	\sqrt{Bs}	Kia	Sd	Sia
		$\Delta dmp, \Delta ds, \sqrt{dp}$					$V_{DP} \Delta d1mp - \Delta dmp$								
from	to	lower	upper	max.	lower	upper	max.	lower	upper	lower	upper	max.	max.	max.	max.
18	30	-6	0	3	0	+10	3	0	+4	-100	0	5	3	8	8
30	50	-8	0	4	0	+12	4	0	+6	-120	0	5	4	8	8
50	80	-9	0	5	0	+15	5	0	+6	-150	0	6	4	8	8
80	120	-10	0	5	0	+20	5	0	+8	-200	0	7	5	9	9
120	180	-13	0	7	0	+25	7	0	+8	-250	0	8	6	10	10
180	250	-15	0	8	0	+30	8	0	+10	-300	0	10	8	11	13
250	315	-15	0	9	0	+35	9	0	+12	-350	0	13	8	13	15
315	400	-23	0	12	0	+40	12	0	+12	-400	0	15	10	15	20
400	500	-27	0	14	0	+45	14	0	+14	-400	0	17	10	17	23

Outer Ring

Tolerances in μm

D mm		$\Delta Dmp, \Delta Ds$		V_{DP}	Kea	SD	Sea
from	to	lower	upper	max.	max.	max.	max.
30	50	-7	0	4	5	8	8
50	80	-9	0	5	5	8	10
80	120	-10	0	5	6	9	11
120	150	-11	0	6	7	10	13
150	180	-13	0	7	8	10	14
180	250	-15	0	8	10	11	15
250	315	-18	0	9	11	13	18
315	400	-20	0	10	13	13	20
400	500	-23	0	12	15	15	23
500	630	-28	0	14	17	18	25
630	800	-35	0	18	20	20	30

DOUBLE ROW CYLINDRICAL ROLLER BEARING

PRECISION CLASS UP

Inner Ring

Tolerances in μm

D mm		cylindrical bore			Δds		tapered bore				ΔBs	$\checkmark Bs$	Kia	Sd	Sia
		Δdmp	Δds	V_{DP}			V_{DP}	$\Delta d1mp$	$-\Delta dmp$						
from	to	lower	upper	max.	lower	upper	max.	lower	upper	lower	upper	max.	max.	max.	max.
18	30	-5	0	2.5	0	+6	2.5	0	+2	-25	0	1.5	1.5	3	3
30	50	-6	0	3	0	+7	3	0	+3	-30	0	2	2	3	3
50	80	-7	0	3.5	0	+8	3.5	0	+3	-40	0	3	2	4	3
80	120	-8	0	4	0	+10	4	0	+4	-50	0	3	3	4	4
120	180	-10	0	5	0	+12	5	0	+4	-60	0	4	3	5	6
180	250	-12	0	6	0	+14	6	0	+5	-75	0	5	4	6	7
250	315	-15	0	8	0	+15	8	0	+6	-100	0	5	4	6	8
315	400	-19	0	10	0	+17	10	0	+6	-100	0	6	5	7	9
400	500	-23	0	12	0	+19	12	0	+7	-100	0	7	5	8	10

Outer Ring

Tolerances in μm

D mm		$\Delta Dmp, \Delta Ds$		V_{DP}	Kea	SD	Sea
from	to	lower	upper	max.	max.	max.	max.
30	50	-5	0	3	3	2	4
50	80	-6	0	3	3	2	4
80	120	-7	0	4	3	3	5
120	150	-8	0	4	4	3	6
150	180	-9	0	5	4	3	7
180	250	-10	0	5	5	4	9
250	315	-12	0	6	6	4	9
315	400	-14	0	7	7	5	12
400	500	-17	0	9	8	5	12
500	630	-20	0	10	9	6	14
630	800	-25	0	13	11	7	17

THRUST BEARINGS

Shaft Washer

Tolerances in μm

d and d2 mm		P0; P6 ; P5			P4; P2		
		Δdmp $\Delta\text{d}2\text{mp}$		V_{DP} $V_{\text{D}2\text{P}}$	Δdmp $\Delta\text{d}2\text{mp}$		V_{DP} $V_{\text{D}2\text{P}}$
over	up to	upper	lower	max.	upper	lower	max.
-	18	0	-8	6	0	-7	5
18	30	0	-10	8	0	-8	6
30	50	0	-12	9	0	-10	8
50	80	0	-15	11	0	-12	9
80	120	0	-20	15	0	-15	11
120	180	0	-25	19	0	-18	14
180	250	0	-30	23	0	-22	17
250	315	0	-35	26	0	-25	19
315	400	0	-40	30	0	-30	23
400	500	0	-45	34	0	-35	26
500	630	0	-50	38	0	-40	30
630	800	0	-75	-	0	-50	-
800	1000	0	-100	-	-	-	-
1000	1250	0	-125	-	-	-	-

Housing Washer

Tolerances in μm

d and d2 mm		P0; P6 ; P5			P4; P2		
		V_{DMP}		V_{DP}	Δdmp		V_{DP}
over	up to	upper	lower	max.	upper	lower	max.
10	18	0	-11	8	0	-7	5
18	30	0	-13	10	0	-8	6
30	50	0	-16	12	0	-9	7
50	80	0	-19	14	0	-11	8
80	120	0	-22	17	0	-13	10
120	180	0	-25	19	0	-15	11
180	250	0	-30	23	0	-20	15
250	315	0	-35	26	0	-25	19
315	400	0	-40	30	0	-28	21
400	500	0	-45	34	0	-33	25
500	630	0	-50	38	0	-38	29
630	800	0	-75	55	0	-45	34
800	1000	0	-100	75	0	-	-
1000	1250	0	-125	-	0	-	-
1250	1600	0	-160	-	0	-	-

AXIAL RUN-OUT SHAFT AND HOUSING WASHERS

Tolerances in μm

d* mm		Si					Se
		P0;	P6;	P5;	P4;	P2	P0; P6; P5; P4; P2
over	up to	max.	max.	max.	max.	max.	max.
-	18	10	5	3	2	1	Identical with S1 of the shaft washer
18	30	10	5	3	2	1.2	
30	50	10	6	3	2	1.5	
50	80	10	7	4	3	2	
80	120	15	8	4	3	2	
120	180	15	9	5	4	3	
180	250	20	10	5	4	3	
250	315	25	13	7	5	4	
315	400	30	15	7	5	4	
400	500	30	18	9	6	-	
500	630	35	21	11	7	-	
630	800	40	25	13	8	-	
800	1000	45	30	15	-	-	
1000	1250	50	35	18	-	-	

Values for S_i and S_e for double-acting thrust bearings are equal to the values corresponding to single-acting thrust bearings and are depending on the bore diameter d , of single-acting bearings.

DOUBLE ACTING THRUST BALL BEARINGS

PRECISION CLASS SP AND UP

Inner Ring

Tolerances in μm

D mm		SP					UP			SP and UP			
		Δdmp		Δds		Sia	Δds		Sia	Hs		Cs	
over	up to	upper	lower	upper	lower	max.	upper	lower	max.	upper	lower	upper	lower
16	18	0	-7	+1	-8	3	0	-5	1.5	+50	-80	0	-30
18	30	0	-8	+1	-9	3	0	-6	1.5	+50	-80	0	-30
30	50	0	-10	+1	-11	3	0	-8	1.5	+60	-100	0	-30
50	80	0	-12	+2	-14	4	0	-9	2	+70	-120	0	-30
80	120	0	-15	+3	-18	4	0	-10	2	+85	-140	0	-30
120	180	0	-18	+3	-21	5	0	-13	3	+95	-160	0	-30
180	250	0	-22	+4	-26	5	0	-15	3	+120	-200	0	-30

Outer Ring

Tolerances in μm

D mm		SP and UP		
		ΔDS	Sea	
over	up to	upper	lower	max.
30	50	-20	-27	Identical with the inner ring of the same bearing
50	80	-24	-33	
80	120	-28	-38	
120	150	-33	-44	
150	180	-33	-46	
180	250	-37	-52	
250	315	-41	-59	

r_{1smax} , r_{3smax} – maximum chamfer in radial direction
 r_{2smax} , r_{4smax} – maximum chamfer in radial direction

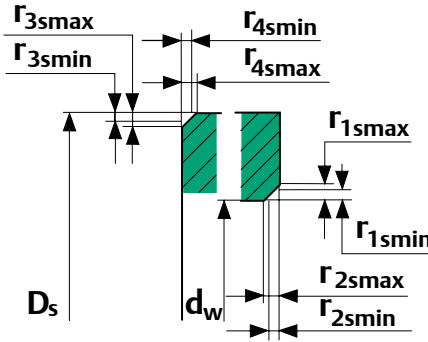

Tapered roller bearings dimensions in inches and mm

inner ring			
d, mm		r_{1smax}	r_{2smax}
over	up to		
	50.8	rsmin. +0.38	rsmin. +0.98
50.8	101.6	rsmin. +0.51	rsmin. +1.27
101.6	254	rsmin. +0.64	rsmin. +1.78
254	381.762	rsmin. +1.0	rsmin. +2
381.762	508	rsmin. +1.5	rsmin. +2.5
508	762	rsmin. +2	rsmin. +3
761	-	rsmin. +2.5	rsmin. +3

outer ring			
d, mm		r_{3smax}	r_{4smax}
over	up to		
-	101.6	rsmin. +0.58	rsmin. +0.107
101.6	168.275	rsmin. +0.64	rsmin. +1.17
168.275	266.7	rsmin. +0.84	rsmin. +1.35
266.7	355.6	rsmin. +1.7	rsmin. +1.7
355.6	508	rsmin. +2	rsmin. +2
508	762	rsmin. +2.5	rsmin. +2.5
762	1016	rsmin. +3	rsmin. +3
1016	-	rsmin. +3.5	rsmin. +3.5

NOTE: The maximum shaft housing corner radius should not exceed the minimum chamfer radius d_w of the bearing bore and outside diameter D_s .

LIMIT DIMENSIONS OF CHAMFER

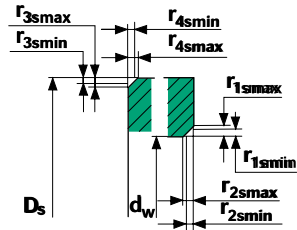
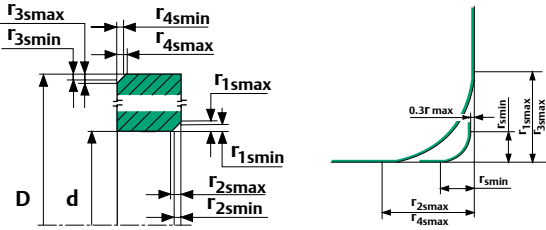

rs min ¹⁾	d		r1s max r3s max	r2s max r4s max
	over	up to		
0.05	-	-	0.1	0.2
0.08	-	-	0.16	0.3
0.1	-	-	0.2	0.4
0.15	-	-	0.3	0.6
0.2	-	-	0.5	0.8
0.3	-	40	0.6	1
	40	-	0.8	1
0.6	-	40	1	2
	40	-	1.3	2
1	-	50	1.5	3
	50	-	1.9	3
1.1	-	120	2	3.5
	120	-	2.5	4
1.5	-	120	2.3	4
	120	-	3	5
2	-	80	3	4.5
	80	220	3.5	5
	280	-	3.8	6
2.1	-	280	4	6.5
	280	-	4.5	7
2.5	-	100	3.8	6
	100	280	4.5	6
	280	-	5	7
3	-	280	5	8
	280	-	5.5	8
4	-	-	6.5	9
5	-	-	8	10
6	-	-	10	13
7.5	-	-	12.5	17
9.5	-	-	15	19
12	-	-	18	24
15	-	-	21	30
19	-	-	25	38

rs min	r1s max r2s max
0.05	0.1
0.08	0.16
0.1	0.2
0.15	0.3
0.2	0.5
0.3	0.8
0.6	1.5
1	2.2
1.1	2.7
1.5	3.5
2	4
2.1	4.5
3	5.5
4	6.5
5	8
6	10
7.5	12.5
9.5	15
12	18
15	21
19	25

1) For smaller sizes

LIMIT DIMENSIONS OF CHAMFER

Tapered roller bearing

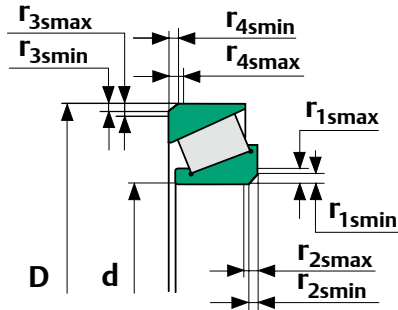

Wide end face chamfer for inner (d) and outer (D)

r1 s min r2 s min r3 s min r4 s min	d or D		r1 s max r3 s max	r2 s max r4 s max
	over	up to		
0.3	-	40	0.7	1.4
	40	-	0.9	1.6
0.6	-	40	1.1	1.7
	40	-	1.1	1.7
1	-	50	1.6	2.5
	50	-	1.9	3
1.5	-	120	2.3	3
	120	250	2.8	3.5
	250	-	3.5	4
2	-	120	2.8	4
	120	250	3.5	4.5
	250	-	4	4
2.5	-	120	3.5	5
	120	250	4	5.5
	250	-	4.5	6
3	-	120	4	5.5
	120	250	4.5	6.5
	250	400	5	7
	400	-	5.5	7.5
4	-	120	5	7
	120	250	5.5	7.5
	250	400	6	7
	400	-	6.5	8.5
5	-	180	6.5	8
	180	-	7.5	9
6	-	180	7.5	10
	180	-	9.5	11

GROOVE AND SNAP RING

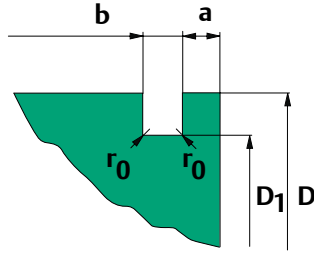

Bearing outer diameter	Size of snap ring groove in mm								
	D1		A Series of sizes 2. 3. 4				b	r0	
	D	max.	min.	max.	min.	max.	min.	max.	min.
30	28.17	27.92	-	-	2.06	1.9	1.65	1.35	0.4
32	30.15	29.9	2.06	1.9	2.06	1.9	1.65	1.35	0.4
35	33.17	32.92	2.06	1.9	1.06	1.9	1.65	1.35	0.4
37	34.77	34.52	-	-	2.06	1.9	1.65	1.35	0.4
40	38.1	37.85	-	-	2.06	1.9	1.65	1.35	0.4
42	39.75	39.5	2.06	1.9	2.06	1.9	1.65	1.35	0.4
44	41.75	41.5	2.06	1.9	-	-	1.65	1.35	0.4
47	44.6	44.35	2.06	1.9	2.46	2.31	1.65	1.35	0.4
50	47.6	47.35	-	-	2.46	2.31	1.65	1.35	0.4
52	49.73	49.48	2.06	1.9	2.46	2.31	1.65	1.35	0.4
55	52.6	52.35	2.08	1.88	-	-	1.65	1.35	0.4
56	53.06	53.35	-	-	2.46	2.31	1.65	1.35	0.4
58	55.6	55.35	1.08	1.88	2.46	2.31	1.65	1.35	0.4
62	59.61	59.11	2.08	1.88	3.28	3.07	2.2	1.9	0.6
65	62.6	62.1	-	-	3.28	3.07	2.2	1.9	0.6
68	64.82	64.31	2.49	2.29	3.28	3.07	2.2	1.9	0.6
72	68.81	68.3	-	-	3.28	3.07	2.2	1.9	0.6
75	71.83	71.32	2.49	2.29	3.28	3.07	2.2	1.9	0.6
80	76.31	76.3	2.49	2.29	3.28	3.07	2.2	1.9	0.6
85	81.81	81.31	-	-	3.28	3.07	2.2	1.9	0.6
90	86.79	86.28	2.87	2.67	3.28	3.07	3	2.7	0.6
95	91.82	91.31	2.87	2.67	-	-	3	2.7	0.6
100	96.8	96.29	2.87	2.67	3.28	3.07	3	2.7	0.6
110	106.81	106.3	2.87	2.67	3.28	3.07	3	2.7	0.6
115	111.81	111.13	2.87	2.67	-	-	3	2.7	0.6
120	115.21	114.71	-	-	4.06	3.86	3.4	3.1	0.6
125	120.22	119.71	2.87	2.67	4.06	3.86	3.4	3.1	0.6
130	125.22	124.71	2.87	2.67	4.06	3.86	3.4	3.1	0.6
140	135.23	134.72	3.71	3.45	4.9	4.64	3.4	3.1	0.6
145	140.23	139.73	3.71	3.45	-	-	3.4	3.1	0.6
150	145.24	144.73	3.71	3.45	4.9	4.65	3.4	3.1	0.6
160	155.22	154.71	3.71	3.45	4.9	4.65	3.4	3.1	0.6
170	163.65	163.14	3.71	3.45	5.69	5.44	3.8	3.5	0.6
180	173.66	173.15	3.71	3.45	5.69	5.44	3.8	3.5	0.6
190	183.64	183.13	-	-	5.69	5.44	3.8	3.5	0.6
200	193.65	193.14	5.69	5.44	5.69	5.44	3.8	3.5	0.6
215	208.6	208.1	-	-	5.69	5.44	3.8	3.5	1

SNAP RING

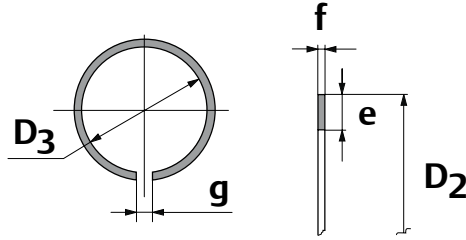

Size of snap ring									Weight g	Snap ring number
D2	D3	$\Delta D3s$		e		f		g		
max.	nominal	upper	lower	max.	min.	max.	min			
34.7	27.9	0	-0.4	3.25	3.1	1.12	1.02	3	2.78	SP30
36.7	29.9	0	-0.4	3.25	3.1	1.12	1.02	3	2.98	SP32
39.7	32.9	0	-0.4	3.25	3.1	1.12	1.02	3	3.22	SP35
41.3	34.5	0	-0.4	3.25	3.1	1.12	1.02	3	3.36	SP37
44.6	37.8	0	-0.4	3.25	3.1	1.12	1.02	3	3.6	SP40
46.3	39.5	0	-0.5	3.25	3.1	1.12	1.02	3	3.75	SP42
48.3	41.5	0	-0.5	3.25	3.1	1.12	1.02	3	4	SP44
52.7	44.3	0	-0.5	4.04	3.89	1.12	1.02	4	5.78	SP50
57.9	49.3	0	-0.5	4.04	3.89	1.12	1.02	4	5.92	SP52
60.7	52.3	0	-0.5	4.04	3.89	1.12	1.02	4	6.17	SP55
61.7	53.2	0	-0.6	4.04	3.89	1.12	1.02	4	6.45	SP56
63.7	55.2	0	-0.6	4.04	3.89	1.12	1.02	4	6.67	SP58
67.7	59.0	0	-0.6	4.04	3.89	1.7	1.6	4	10.5	SP62
70.7	62.0	0	-0.6	4.04	3.89	1.7	1.6	4	11	SP65
74.6	64.2	0	-0.6	4.85	4.7	1.7	1.6	5	12.6	SP68
78.6	68.2	0	-0.6	4.85	4.7	1.7	1.6	5	14.7	SP72
81.6	71.2	0	-0.6	4.85	4.7	1.7	1.6	5	15.3	SP75
86.6	76.2	0	-0.6	4.85	4.7	1.7	1.6	5	16.3	SP80
91.6	81.2	0	-0.6	4.85	4.7	1.7	1.6	5	17.5	SP85
96.5	86.2	0	-0.6	4.85	4.7	2.46	2.36	5	26.6	SP90
101.6	91.2	0	-0.6	4.85	4.7	2.46	2.36	5	28.2	SP95
106.6	96.2	0	-0.8	4.85	4.7	2.46	2.36	5	29.2	SP100
116.6	106.2	0	-0.8	4.85	4.7	2.46	2.36	5	32.8	SP110
121.6	112.2	0	-0.8	4.85	4.7	2.46	2.36	5	34.4	SP115
129.7	114.6	0	-0.8	7.21	7.06	2.82	2.72	7	60.6	SP120
134.7	119.6	0	-0.8	7.21	7.06	2.82	2.72	7	63	SP125
139.7	124.6	0	-0.8	7.21	7.06	2.82	2.72	7	65.6	SP130
149.7	134.6	0	-1.2	7.21	7.06	2.82	2.72	7	70.6	SP140
154.7	139.6	0	-1.2	7.21	7.06	2.82	2.72	7	73	SP145
159.7	144.5	0	-1.2	7.21	7.06	2.82	2.72	7	77.2	SP150
169.7	154.5	0	-1.2	7.21	7.06	2.28	2.72	7	81	SP160
182.9	162.9	0	-1.2	9.6	9.45	3.1	3	10	122	SP170
192.9	172.8	0	-1.2	9.6	9.45	3.1	3	10	128	SP180
202.9	182.8	0	-1.4	9.6	9.45	3.1	3	10	139	SP190
212.9	192.8	0	-1.4	9.6	9.45	3.1	3	10	148	SP200
227.8	277.6	0	-1.4	9.6	9.45	3.1	3	10	160	SP215

Dimensions D_2 and g refer to the snap ring fitted in to the bearing groove D_3 , e represents the nominal inner diameter of the snap ring before mounting

ABUTMENT RECOMMENDATIONS

Filet Radii

The bearing tables give the maximum filet radius which the bearing will clear.

A filet radius which is too large can cause distortion of the bearing ring, and may cause misalignment of the bearing relative to the seating.

Abutment Shoulders

These must be flat, aligned with the axis of rotation, and free from burrs, to maintain bearing alignment and give proper support to the bearing faces.

Minimum Abutment Diameter

Minimum abutment diameters for bearings not subject to significant axial load are:

$$\text{Inner ring abutment} = d + 4r \text{ (minimum)}$$

$$\text{Outer ring abutment} = D - 4r \text{ (minimum)}$$

where:

d = bearing bore diameter

r = fillet radius (from bearing tables)

D = bearing outside diameter

Maximum Abutment Diameters

The normal recommendations concerning maximum abutments for radial ball and standard cylindrical roller bearings are given in tables.

It may not always be possible for small bearings to satisfy the minimum abutment recommendations, and in such cases the abutment should be made to the maximum figure in the table.

Abutments For Thrust Bearings

Thrust bearing abutments must be accurately machined flat and aligned with the axis of rotation, as any misalignment will induce creep. The thrust bearing washers should be supported beyond the pitch diameter of the ball assembly. This may be calculated as:

$$Pcd = (d+D)/2$$

where:

d = small bore diameter

D = large outside diameter

Maximum Abutments, Metric Sizes

Table

MINIATURE SERIES AND SMALL SELF ALIGNING BALL BEARING				MINIATURE SERIES WITH SHIELDS OR SEALS	
600 and 100				600 Z, - 2Z 600 RS, - 2RS	
		Inner ring abutment	Outer ring abutment	Inner ring abutment	Outer ring abutment
600 serie	100 serie	mm	mm	mm	mm
681		1.5*	2.6*		
681 ½		2.1*	3.4*		
682		2.6	4.2		
682 ½		3.3	5.3		
683		4.2	6.2		
684		5.4	7.7		
685		6.6	9.8		
686		7.7	11.6		
691		1.8	3.4		
691 ½		2.3	4.3		
692		2.8	5.2		
692 ½		3.8	6.2		
693		3.7	6.9		
602 ½		3.7	6.9		
607		9.4	15.8	9.4	16.5
608	108	11.0	19.0	10.5	19.5
609		12.8	20.7	12.8	21.2
623		4.8	7.9	4.8	8.8
624		6.4	11.1	6.4	11.3
625		6.8	13.2	6.8	13.9
626	126	9.4	15.8	9.0	16.5
627	127	11.1	19.0	10.5	19.5
629	129	13.2	22.8	12.5	23.5
634		6.8	13.2	6.8	13.9
635	135	9.4	15.8	9.0	16.5
636		11.1	19.0	10.5	19.5

Maximum Abutments, Metric Sizes

Table

d	EXTRA LIGHT NARROW SERIES – BALL BEARINGS		EXTRA LIGHT SERIES BALL AND ROLLER BEARINGS	
	16000		6000, N1000 6000 Z, - 2Z 6000 RS, - 2RS	
	Inner ring abutment	Outer ring abutment	Inner ring abutment	Outer ring abutment
	mm	mm	mm	mm
00	12.5	23.0	12.5	23.0
01	15.0	25.0	14.5	25.0
02	18.5	29.0	18.0	28.5
03	20.0	32.0	20.5	31.5
04	30.0	42.0	30.0	42.0
05	30.0	42.0	30.0	42.0
06	36.0	49.0	35.5	50.0
07	42.0	55.0	41.0	56.5
08	47.0	60.5	46.0	62.0
09	52.5	67.5	51.5	70.0
10	57.5	72.5	57.0	74.5
11	64.5	80.5	63.0	82.5
12	69.5	85.5	67.5	88.0
13	74.5	90.5	73.0	92.5
14	80.0	100.0	78.5	102.0
15	85.0	105.0		
16	92.0	113.0		
17	97.0	118.0		
18	103.0	127.0		

MAGNETO SERIES BALL BEARINGS EN					
d	Inner ring abutment	Outer ring abutment	d	Inner ring abutment	Outer ring abutment
	mm	mm		mm	mm
05	7.5	13.8	13	16.9	26.4
06	8.9	18.5	14	19.8	30.9
07	9.9	19.5	15	19.8	30.9
08	11.3	20.9	16	21.0	33.7
09	13.7	24.8	17	23.6	36.3
10	13.7	24.8	18	23.7	33.3
11	16.9	26.4	19	23.7	33.3
12	16.9	26.4	20	25.9	41.8

Maximum Abutments, Metric Sizes

Table

d	EXTRA LIGHT SERIES		LIGHT SERIES	
	7000		7200, NP200, NUP200, NJ200	
	Inner ring abutment	Outer ring abutment	Inner ring abutment	Outer ring abutment
	mm	mm	mm	mm
00	15.0	20.5	16.5	24.0
01	17.0	23.0	18.0	26.0
02	19.5	27.0	21.0	29.0
03	22.0	30.0	24.0	33.0
04	26.5	35.5	28.5	38.5
05	31.5	40.5	33.5	43.5
06	38.0	48.0	40.0	52.5
07	43.5	54.5	45.5	60.0
08	48.5	59.5	52.0	67.0
09	54.0	66.5	57.0	72.0
10	59.0	71.5	62.5	77.5
11	66.5	80.0	69.0	86.0
12	71.5	85.0	76.0	94.0
13	76.5	90.0	82.5	102.0
14	82.5	98.5	87.5	107.0
15	87.5	103.5	91.5	112.0
16	94.0	111.0	98.5	122.0
17	99.0	116.0	105.5	130.0
18	106.0	125.5	110.5	137.0
19	111.0	130.5	118.0	147.0
20	116.0	135.5	124.5	154.0
22	128.5	152.5	138.0	171.5
24	138.5	163.0		
26	152.0	179.0		
28	162.0	189.0		

MEDIUM SERIES					
7300, QJ300, NF300, NP300, NUP300, NC300, NJ300					
d	Inner ring abutment	Outer ring abutment	d	Inner ring abutment	Outer ring abutment
	mm	mm		mm	mm
02	23.5	33.5	11	74.0	99.0
04	30.0	42.5	12	81.0	108.0
05	37.0	52.0	13	88.0	117.0
06	44.0	59.0	14	94.5	124.0
07	48.5	66.0	15	100.5	132.5
08	56.0	74.0	16	108.5	142.0
09	61.5	82.0	17	113.5	150.0
10	68.5	90.5	18	120.5	157.5
			19	127.5	166.0
			20	136.0	177.5
			22	150.5	197.0

Maximum Abutments, Metric Sizes

Table

d	LIGHT SERIES		LIGHT SERIES WITH SHIELDS OR SEALS	
	6200 N200 4200 NU200 1200		6200 Z, - ZZ, - RS - 2RS	
	Inner ring abutment	Outer ring abutment	Inner ring abutment	Outer ring abutment
	mm	mm	mm	mm
00	15.0	25.5	15.0	26.0
01	16.5	28.0	16.0	28.0
02	19.5	31.0	19.0	31.0
03	22.0	35.0	22.0	35.5
04	26.0	41.0	26.0	42.5
05	31.0	46.5	31.0	47.5
06	37.5	55.5	37.5	56.5
07	43.5	64.5	43.5	65.5
08	49.0	71.5	49.0	73.5
09	53.5	76.5	53.0	77.5
10	59.0	81.5	59.0	83.5
11	65.0	90.5		
12	71.0	100.0	71.0	101.5
13	77.0	108.5		
14	81.5	114.0	81.5	115.5
15	86.5	118.5		
16	94.0	129.5		
17	98.5	137.0		
18	105.5	145.5		
19	111.0	154.5		
20	117.0	162.0		
21	124.5	172.5		
22	130.0	181.0		
23				
24	140.5	195.0		
26	154.0	208.5		
28	166.0	225.0		
32	192.0	260.5		

Maximum Abutments, Metric Sizes

Table

d	MEDIUM SERIES		MEDIUM SERIES WITH SHIELDS OR SEALS	
	6300 N300 4300 NU300 1300		6300 Z, - ZZ, - RS - 2RS	
	Inner ring abutment	Outer ring abutment	Inner ring abutment	Outer ring abutment
	mm	mm	mm	mm
00	16.0	29.0	16.0	30.0
01	17.5	31.5	17.5	33.0
02	21.0	36.5	21.0	37.5
03	23.5	40.5	23.5	41.0
04	27.0	45.0	27.0	45.5
05	34.0	55.0	34.0	55.5
06	39.0	63.0	39.0	63.5
07	45.0	70.0	45.0	70.0
08	50.5	79.5	50.5	79.0
09	56.6	88.5	56.5	88.5
10	63.0	96.5	63.0	96.5
11	69.5	106.5	69.5	108.5
12	75.0	115.0		
13	82.0	125.5		
14	87.0	133.5		
15	93.0	142.5		
16	99.0	152.0		
17	104.5	160.5		
18	111.5	169.0		
19	118.5	177.5		
20	127.5	188.5		
21	131.5	198.5		
22	138.5	212.0		

d	HEAVY SERIES 6400				
	Inner ring abutment	Outer ring abutment	d	Inner ring abutment	Outer ring abutment
	mm	mm		mm	mm
03	30.5	52.5	11	75.0	123.5
04	34.5	60.0	12	82.0	132.0
05	38.5	67.0	13	89.0	139.5
06	45.5	78.0	14	97.5	157.0
07	51.0	87.0	15	102.0	163.5
08	58.0	95.0	16	105.5	176.0
09	65.0	104.5	17	114.0	183.0
10	69.0	114.5	18	122.5	193.0



SINGLE ROW DEEP GROOVE BALL BEARINGS

Dimensions in accordance with ISO 15-2008

The single row deep groove ball bearing is the most popular type of rolling bearing. Because the inner and outer raceway radii are only slightly larger than the ball diameter, it has considerable axial load carrying capacity in either direction, as well as radial loading. They are suitable for high speeds, and can be supplied with shields or seals - for example, Suffix ZZ is added for shielded type, and suffix 2RS is added for sealed type. The shielded type have a running clearance between the inner-race and the metal shield, whereas the seals (made from synthetic rubber), make contact with the inner race. Both shielded and sealed bearings are supplied with the correct amount of lithium base grease, which has an operating temperature of -30 to $+120^{\circ}\text{C}$ (-22°F + 248°F).

Cages are normally two pieced pressed steel. For higher speeds, machined brass cages and reinforced plastics are used. Plastic cages are limited on operating temperature to about 120°C (248°F) maximum.

Deep groove ball bearings can also be supplied with snap ring and groove, which provide a simple and space-saving means of locating the bearing in the housing. Bearings with this feature have the suffix NR added to the designation.

Bearings with the EMQ suffix are specifically for electric motors. These bearings are manufactured specifically to reduce vibration and noise level.

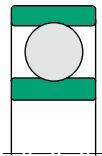

open

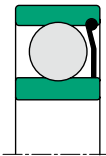

Z
1 shield

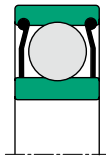

ZZ
2 shields

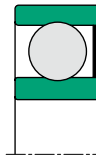

RS
1 seal

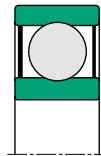

2RS
2 seals

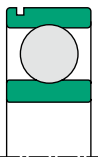

N
circular
groove
for snap ring

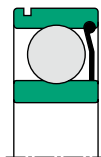

ZN
1 shield
circular
groove
for snap ring

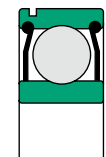

ZZN
2 shields
circular
groove
for snap ring

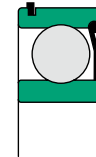

ZNR
1 shield
circular
groove
with
snap ring

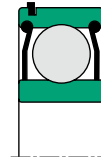

ZZNR
2 shields
circular
groove

Deep Groove Ball Bearings

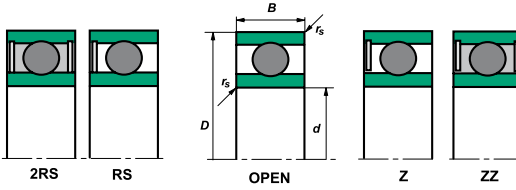

Bearing		ISO dimensions			Load ratings		Speed limits		Weight kg	Dim. rs min
Type	Version	d mm	D	B	C kN	Co kN	Grease r/min	Oil r/min		
623		3	10	4	0,63	0,22	50000	60000	0,002	0,1
623	ZZ	3	10	4	0,63	0,22	50000		0,002	0,1
624		4	13	5	1,3	4,85	40000	48000	0,003	0,2
624	ZZ	4	13	5	1,3	4,85	40000		0,003	0,2
634		4	16	5	1,34	0,5	36000	43000	0,005	0,3
634	ZZ	4	16	5	1,34	0,5	36000		0,005	0,3
625		5	16	5	1,88	6,8	36000	43000	0,005	0,3
625	ZZ	5	16	5	1,88	6,8	36000		0,005	0,3
635		5	19	6	2,34	0,88	32000	40000	0,009	0,3
635	ZZ	5	19	6	2,34	0,88	32000		0,009	0,3
626		6	19	6	2,34	0,88	32000	40000	0,008	0,3
626	ZZ	6	19	6	2,34	0,88	32000		0,008	0,3
626	2RS	6	19	6	2,34	0,88	22000		0,008	0,3
636		6	25	7	3,3	1,37	30000	36000	0,014	0,3
636	ZZ	6	25	7	3,3	1,37	30000		0,014	0,3
636	2RS	6	25	7	3,3	1,37			0,014	0,3
607		7	19	6	2,34	0,88	36000	43000	0,0075	0,3
607	ZZ	7	19	6	2,34	0,88	36000		0,0075	0,3
607	2RS	7	19	6	2,34	0,88			0,0075	0,3
627		7	22	7	3,3	1,37	30000	36000	0,013	0,3
637		7	26	9	4,56	1,98	28000	34000	0,024	0,3
637	ZZ	7	26	9	4,56	1,98	28000		0,024	0,3
637	2RS	7	26	9	4,56	1,98			0,024	0,3
608		8	22	7	3,3	1,37	34000	40000	0,012	0,3



Bearing		ISO dimensions			Load ratings		Speed limits		Weight kg	Dim. rs min
Type	Version	d mm	D	B	C kN	Co kN	Grease r/min	Oil r/min		
608	ZZ	8	22	7	3,3	1,37	34000		0,012	0,3
608	2RS	8	22	7	3,3	1,37			0,012	0,3
628		8	24	8	3,35	1,43	28000	34000	0,017	0,3
628	ZZ	8	24	8	3,35	1,43	28000		0,017	0,3
628	2RS	8	24	8	3,35	1,43			0,017	0,3
628/6	ZZ	6	13	5	1,08	0,44	40000	50000	0,00264	0,15
628/7	ZZ	7	14	5	1,17	0,51	40000	45000	0,00297	0,15
638		8	28	9	4,55	1,97	28000	34000	0,028	0,3
638	ZZ	8	28	9	4,55	1,97	28000		0,028	0,3
609		9	24	7	3,35	1,43	32000	38000	0,014	0,3
609	ZZ	9	24	7	3,35	1,43	32000		0,014	0,3
609	2RS	9	24	7	3,35	1,43			0,014	0,3
629		9	26	8	4,55	1,97	28000	34000	0,019	0,3
629	ZZ	9	26	8	4,55	1,97	28000		0,019	0,3
629	2RS	9	26	8	4,55	1,97			0,019	0,3
639		9	30	10	4,65	2,07	24000	30000	0,35	0,6
639	ZZ	9	30	10	4,65	2,07	24000		0,35	0,6
6000		10	26	8	4,55	1,97	30000	36000	0,02	0,3
6000	ZZ	10	26	8	4,55	1,97	30000		0,02	0,3
6000	2RS	10	26	8	4,55	1,97			0,02	0,3
6200		10	30	9	5,1	2,39	24000	30000	0,032	0,6
6200	ZZ	10	30	9	5,1	2,39	24000		0,032	0,6
6200	2RS	10	30	9	5,1	2,39			0,032	0,6
6300		10	35	11	8,1	3,45	22000	26000	0,055	0,6

Deep Groove Ball Bearings

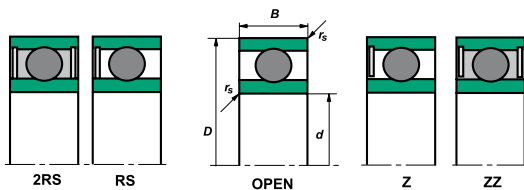

Bearing		ISO dimensions			Load ratings		Speed limits		Weight kg	Dim. rs min
Type	Version	d mm	D	B	C kN	Co kN	Grease r/min	Oil r/min		
6300	ZZ	10	35	11	8,1	3,45	22000		0,055	0,6
6300	2RS	10	35	11	8,1	3,45			0,055	0,6
61800		10	19	5	1,7	0,83	34000	40000	0,005	0,3
61800	ZZ	10	19	5	1,7	0,83	34000		0,005	0,3
61900		10	22	6	1,95	0,75	32000	38000	0,01	0,3
61900	ZZ	10	22	6	1,95	0,75	32000		0,01	0,3
6001		12	28	8	5,1	2,37	28000	32000	0,021	0,3
6001	ZZ	12	28	8	5,1	2,37	28000		0,021	0,3
6001	2RS	12	28	8	5,1	2,37			0,021	0,3
6201		12	32	10	6,8	3,05	22000	28000	0,038	0,6
6201	ZZ	12	32	10	6,8	3,05	22000		0,038	0,6
6201	2RS	12	32	10	6,8	3,05			0,038	0,6
6301		12	37	12	9,7	4,2	20000	24000	0,06	1
6301	ZZ	12	37	12	9,7	4,2	20000		0,06	1
6301	2RS	12	37	12	9,7	4,2			0,06	1
16001		12	28	7	5,1	2,37	28000	32000	0,026	0,3
61801		12	21	5	1,8	0,95	32000	38000	0,006	0,3
61801	ZZ	12	21	5	1,8	0,95	32000		0,006	0,3
61901		12	24	6	2,9	1,45	30000	36000	0,011	0,3
61901	ZZ	12	24	6	2,9	1,45	30000		0,011	0,3
6002		15	32	9	5,6	2,83	24000	28000	0,028	0,3
6002	ZZ	15	32	9	5,6	2,83	24000		0,028	0,3
6002	2RS	15	32	9	5,6	2,83	24000		0,028	0,3
6202		15	35	11	7,75	3,57	20000	24000	0,045	0,5

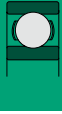

Bearing		ISO dimensions			Load ratings		Speed limits		Weight kg	Dim. rs min
Type	Version	d mm	D	B	C kN	Co kN	Grease r/min	Oil r/min		
6202	ZZ	15	35	11	7,75	3,57	20000		0,045	0,5
6202	2RS	15	35	11	7,75	3,57	20000		0,045	0,5
6302		15	42	13	11,4	5,45	17000	20000	0,083	1
6302	ZZ	15	42	13	11,4	5,45	17000		0,083	1
6302	2RS	15	42	13	11,4	5,45			0,083	1
16002		15	32	8	5,6	2,83	24000	28000	0,037	0,3
61802		15	24	5	2	1,25	28000	34000	0,007	0,3
61802	ZZ	15	24	5	2	1,25	28000		0,007	0,3
61902		15	28	7	4,35	2,26	26000	30000	0,017	0,3
61902	ZZ	15	28	7	4,35	2,26	26000		0,017	0,3
6003		17	35	10	6	3,25	22000	26000	0,035	0,3
6003	ZZ	17	35	10	6	3,25	22000		0,035	0,3
6003	2RS	17	35	10	6	3,25			0,035	0,3
6203		17	40	12	9,55	4,8	17000	20000	0,066	0,6
6203	ZZ	17	40	12	9,55	4,8	17000		0,066	0,6
6203	2RS	17	40	12	9,55	4,8	17000		0,066	0,6
6303		17	47	14	13,6	6,65	15000	18000	0,112	1
6303	ZZ	17	47	14	13,6	6,65	15000		0,112	1
6303	2RS	17	47	14	13,6	6,65			0,112	1
16003		17	35	8	6	3,25	22000	26000	0,04	0,3
61803		17	26	5	2,2	1,4	26000	30000	0,009	0,3
61803	ZZ	17	26	5	2,2	1,4	26000		0,009	0,3
61903		17	30	7	4,35	2,3	24000	28000	0,018	0,3
61903	ZZ	17	30	7	4,35	2,3	24000		0,018	0,3

Deep Groove Ball Bearings

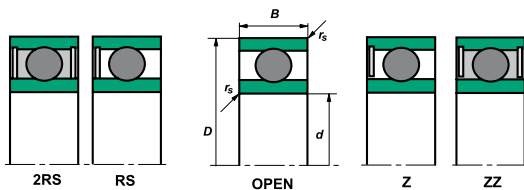

Bearing		ISO dimensions			Load ratings		Speed limits		Weight kg	Dim. rs min
Type	Version	d mm	D	B	C kN	Co kN	Grease r/min	Oil r/min		
6004		20	42	12	9,4	5	18000	20000	0,063	0,6
6004	ZZ	20	42	12	9,4	5	18000		0,063	0,6
6004	2RS	20	42	12	9,4	5			0,063	0,6
6204		20	47	14	12,8	6,6	15000	18000	0,116	1
6204	ZZ	20	47	14	12,8	6,6	15000		0,116	1
6204	2RS	20	47	14	12,8	6,6			0,116	1
6304		20	52	15	15,9	7,9	14000	17000	0,14	1,1
6304	ZZ	20	52	15	15,9	7,9	14000		0,14	1,1
6304	2RS	20	52	15	15,9	7,9			0,14	1,1
16004		20	42	8	7,95	4,5	18000	20000	0,05	0,3
61804		20	32	7	3,45	2,25	22000	26000	0,02	0,3
61804	ZZ	20	32	7	3,45	2,25	22000		0,02	0,3
61904		20	37	9	6,55	3,65	19000	22000	0,036	0,3
61904	ZZ	20	37	9	6,55	3,65	19000		0,036	0,3
6005		25	47	12	10,1	5,85	15000	18000	0,08	0,6
6005	ZZ	25	47	12	10,1	5,85	15000		0,08	0,6
6005	2RS	25	47	12	10,1	5,85			0,08	0,6
6205		25	52	15	14	7,85	13000	15000	0,13	1
6205	ZZ	25	52	15	14	7,85	13000		0,13	1
6205	2RS	25	52	15	14	7,85			0,13	1
6305		25	62	17	20,6	11,2	11000	13000	0,25	1,1
6305	ZZ	25	62	17	20,6	11,2	11000		0,25	1,1
6305	2RS	25	62	17	20,6	11,2			0,25	1,1
6405		25	80	21	37,2	18,7	9000	11000	0,0575	1,5



Bearing		ISO dimensions			Load ratings		Speed limits		Weight kg	Dim. rs min
Type	Version	d mm	D	B	C kN	Co kN	Grease r/min	Oil r/min		
16005		25	47	8	8,85	5,6	15000	18000	0,058	0,3
61805		25	37	7	4,35	2,95	18000	22000	0,022	0,3
61805	ZZ	25	37	7	4,35	2,95	18000		0,022	0,3
61905		25	42	9	7	4,45	16000	19000	0,041	0,3
61905	ZZ	25	42	9	7	4,45	16000		0,041	0,3
6206		30	62	16	19,5	11,3	10000	13000	0,21	1
6206	ZZ	30	62	16	19,5	11,3	10000		0,21	1
6206	2RS	30	62	16	19,5	11,3	7500		0,21	1
6306		30	72	19	29,9	15,8	9000	11000	0,371	1,1
6306	ZZ	30	72	19	29,9	15,8	9000		0,371	1,1
6306	2RS	30	72	19	29,9	15,8	6000		0,371	1,1
6406		30	90	23	47,3	24,5	8500	10000	0,785	1,5
16006		30	55	9	11,2	7,35	12000	15000	0,085	3
61806		30	42	7	4,4	2,9	15000	18000	0,027	0,3
61906		30	47	9	7,8	4,7	14000	17000	0,045	0,3
6007		35	62	14	15,9	10,3	10000	13000	0,164	1
6207		35	72	17	25,7	15,4	9000	11000	0,315	1,1
6207	ZZ	35	72	17	25,7	15,4	9000		0,315	1,1
6207	2RS	35	72	17	25,7	15,4	6000		0,315	1,1
6307		35	80	21	33,5	18,3	8500	10000	0,45	1,5
6307	ZZ	35	80	21	33,5	18,3	8500		0,45	1,5
6307	2RS	35	80	21	33,5	18,3	5600		0,45	1,5
6407		35	100	25	55,5	29,4	7000	8500	0,954	1,5
16007		35	62	9	12,2	8,85	10000	13000	0,111	0,3

Deep Groove Ball Bearings

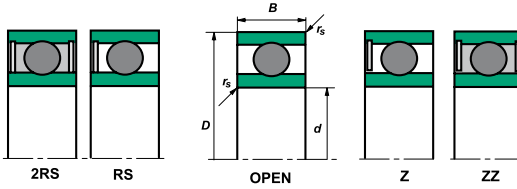

Bearing		ISO dimensions			Load ratings		Speed limits		Weight kg	Dim. rs min
Type	Version	d mm	D	B	C kN	Co kN	Grease r/min	Oil r/min		
61807		35	47	7	4	3,25	13000	16000	0,031	0,3
61907		35	55	10	9,5	6,2	12000	14000	0,073	0,6
6008		40	68	15	16,8	11,6	9500	12000	0,21	1
6008	ZZ	40	68	15	16,8	11,6	9500		0,21	1
6008	2RS	40	68	15	16,8	11,6	6000		0,21	1
6208		40	80	18	32	17,8	8500	10000	0,402	1,1
6208	ZZ	40	80	18	32	17,8	8500		0,402	1,1
6208	2RS	40	80	18	32	17,8	5600		0,402	1,1
6308		40	90	23	40,7	24	7500	9000	0,635	1,5
6308	ZZ	40	90	23	40,7	24	7500		0,635	1,5
6308	2RS	40	90	23	40,7	24	5000		0,635	1,5
6408		40	110	27	64	36	6700	7500	1,23	2
16008		40	68	9	13,3	9,8	9500	12000	0,13	0,3
61908		40	62	12	14,5	10,2	11000	13000	0,111	0,6
6009		45	75	16	21	15	9000	11000	0,261	1
6009	ZZ	45	75	16	21	15	9000		0,261	1
6009	2RS	45	75	16	21	15	5600		0,261	1
6209		45	85	19	32,7	20,2	7500	9000	0,414	1,1
6209	ZZ	45	85	19	32,7	20,2	7500		0,414	1,1
6209	2RS	45	85	19	32,7	20,2	5300		0,414	1,1
6309		45	100	25	52,8	31,7	6700	8000	0,838	1,5
6309	ZZ	45	100	25	52,8	31,7	6700		0,838	1,5
6309	2RS	45	100	25	52,8	31,7	4500		0,838	1,5
6409		45	120	29	76,8	44,9	5600	6700	1,54	2

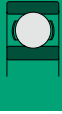

Bearing		ISO dimensions			Load ratings		Speed limits		Weight kg	Dim. rs min
Type	Version	d mm	D	B	C kN	Co kN	Grease r/min	Oil r/min		
16009		45	75	10	15,5	12,3	9000	11000	0,17	0,6
61809		45	58	7	6,4	5,6	9500	12000	0,043	0,3
61909		45	68	12	14	9,8	9700	11000	0,12	0,6
6010		50	80	16	21,8	16,5	8500	10000	0,26	1
6010	ZZ	50	80	16	21,8	16,5	8500		0,26	1
6010	2RS	50	80	16	21,8	16,5	5300		0,26	1
6210		50	90	20	35,1	23,1	7000	8500	0,46	1,1
6210	ZZ	50	90	20	35,1	23,1	7000		0,46	1,1
6210	2RS	50	90	20	35,1	23,1	4500		0,46	1,1
6310		50	110	27	61,8	37,7	6000	7000	1,08	2
6310	ZZ	50	110	27	61,8	37,9	6000		1,06	2
6310	2RS	50	110	27	61,8	37,9	4000		1,06	2
6410		50	130	31	87,1	52	5000	6000	1,89	2,1
16010		50	80	10	16,3	13,1	8500	10000	0,188	0,6
61810		50	65	7	6,8	6,3	9500	12000	0,057	0,3
61910		50	72	12	14,5	10,4	9000	11000	0,13	0,6
6011		55	90	18	28,3	21,2	7500	9000	0,39	1,1
6011	ZZ	55	90	18	28,3	21,2	7500		0,39	1,1
6011	2RS	55	90	18	28,3	21,2	4500		0,39	1,1
6211		55	100	21	43,4	29,3	6300	7500	0,611	1,5
6211	ZZ	55	100	21	43,4	29,3	6300		0,611	1,5
6211	2RS	55	100	21	43,4	29,3	4000		0,611	1,5
6311		55	120	29	71,5	44,6	5300	6300	1,38	2
6311	ZZ	55	120	29	71,5	44,6	5300		1,38	2

Deep Groove Ball Bearings

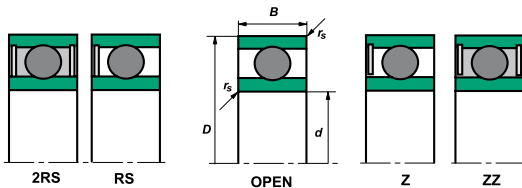

Bearing		ISO dimensions			Load ratings		Speed limits		Weight kg	Dim. rs min
Type	Version	d mm	D	B	C kN	Co kN	Grease r/min	Oil r/min		
6311	2RS	55	120	29	71,5	44,6	3600		1,38	2
6411		55	140	33	100	62	4800	5600	2,3	2,1
16011		55	90	11	19,3	16,3	7500	9000	0,26	0,6
61811		55	72	9	9	8,5	8500	10000	0,083	0,3
6012		60	95	18	29,4	23,2	6700	8000	0,42	1,1
6012	ZZ	60	95	18	29,4	23,2	6700		0,42	1,1
6012	2RS	60	95	18	29,4	23,2	4300		0,42	1,1
6212		60	110	22	52,4	36	6000	7000	0,78	1,5
6212	ZZ	60	110	22	52,4	36	6000		0,78	1,5
6212	2RS	60	110	22	52,4	36	4000		0,78	1,5
6312		60	130	31	81,8	51,9	5000	6000	1,72	2,1
6312	ZZ	60	130	31	81,8	51,9	5000		1,72	2,1
6312	2RS	60	130	31	81,8	51,9	3400		1,72	2,1
6412		60	150	35	110	70,8	4300	5000	2,76	2,1
16012		60	95	11	20	17,6	7000	8500	0,28	0,6
61812		60	78	10	8,7	6,7	8000	9500	0,12	0,3
6013		65	100	18	30,5	25,2	6300	7500	0,44	1,1
6013	ZZ	65	100	18	30,5	25,2	6300		0,44	1,1
6013	2RS	65	100	18	30,5	25,2	4000		0,44	1,1
6213		65	120	23	57,2	40	5300	6300	0,995	1,5
6213	ZZ	65	120	23	57,2	40	5300		0,995	1,5
6213	2RS	65	120	23	57,2	40	3600		0,995	1,5
6313		65	140	33	92,7	59,7	4800	5600	2,1	2,1
6313	ZZ	65	140	33	92,7	59,7	4800		2,1	2,1

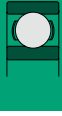

Bearing		ISO dimensions			Load ratings		Speed limits		Weight kg	Dim. rs min
Type	Version	d mm	D	B	C kN	Co kN	Grease r/min	Oil r/min		
6313	2RS	65	140	33	92,7	59,7	3000		2,1	2,1
6413		65	160	37	118	79	4000	4800	3,3	2,1
16013		65	100	11	22,9	19,6	6300	7500	0,3	0,6
61813		65	85	10	12,2	12	7000	8500	0,13	0,6
6014		70	110	20	38,1	30,9	6000	7000	0,6	1,1
6014	ZZ	70	110	20	38,1	30,9	6000		0,6	1,1
6014	2RS	70	110	20	38,1	30,9	3600		0,6	1,1
6214		70	125	24	62,2	44,1	5000	6000	1,07	1,5
6214	ZZ	70	125	24	62,2	44,1	5000		1,07	1,5
6214	2RS	70	125	24	62,2	44,1	3400		1,07	1,5
6314		70	150	35	104	68,1	4500	5300	2,5	2,1
6314	ZZ	70	150	35	104	68,1	4500		2,5	2,1
6314	2RS	70	150	35	104	68,1	2800		2,5	2,1
6414		70	180	42	144	104	3800	4500	4,85	3
16014		70	110	13	27,9	25	6000	7000	0,433	0,6
61814		70	90	10	12,5	10	6700	8000	0,16	0,6
61914	2RS	70	100	16	23,7	21,2	7700	6500	0,33	1
6015		75	115	20	39,7	33,5	5600	6700	0,64	1,1
6015	ZZ	75	115	20	39,7	33,5	5600		0,64	1,1
6015	2RS	75	115	20	39,7	33,5	3400		0,64	1,1
6215		75	130	25	67,4	49,3	4800	5600	1,18	1,5
6215	ZZ	75	130	25	67,4	49,3	4800		1,18	1,5
6215	2RS	75	130	25	67,4	49,3	3200		1,18	1,5
6315		75	160	37	113	77	4000	4800	3,03	2,1

Deep Groove Ball Bearings

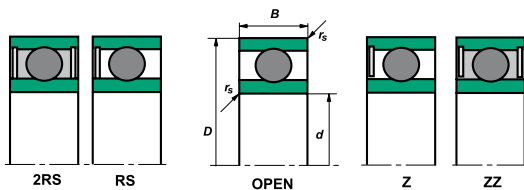

Bearing		ISO dimensions			Load ratings		Speed limits		Weight kg	Dim. rs min
Type	Version	d mm	D	B	C kN	Co kN	Grease r/min	Oil r/min		
6315	ZZ	75	160	37	113	77	4000		3,03	2,1
6315	2RS	75	160	37	113	77	2800		3,03	2,1
6415		75	190	45	154	115	3600	4300	6,5	3
16015		75	115	13	28,5	26,8	5600	6700	0,46	0,6
6016		80	125	22	47,6	39,8	5300	6300	0,85	1,1
6016	ZZ	80	125	22	47,6	39,8	5300		0,85	1,1
6016	2RS	80	125	22	47,6	39,8	3600		0,85	1,1
6216		80	140	26	72,7	53	4500	5300	1,4	2
6216	ZZ	80	140	26	72,7	53	4500		1,4	2
6216	2RS	80	140	26	72,7	53	3000		1,4	2
6316		80	170	39	123	86,5	3800	4500	3,6	2,1
6316	ZZ	80	170	39	123	86,5	3800		3,6	2,1
6416		80	200	48	164	125	3400	4000	7,5	3
16016		80	125	14	31,9	29,7	5300	6300	0,6	0,6
61816		80	100	10	12,9	13,7	6000	7000	0,16	0,6
61916		80	110	16	25,1	20,5	5600	6700	0,38	1
6017		85	130	22	49,5	43,1	5000	6000	0,89	1,1
6017	ZZ	85	130	22	49,5	43,1	5000		0,89	1,1
6017	2RS	85	130	22	49,5	43,1	3400		0,89	1,1
6217		85	150	28	84	61,9	4300	5000	1,8	2
6217	ZZ	85	150	28	84	61,9	4300		1,8	2
6217	2RS	85	150	28	84	61,9	2800		1,8	2
6317		85	180	41	133	96,6	3600	4300	4,2	3
6317	ZZ	85	180	41	133	96,6	3600		4,2	3

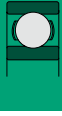

Bearing		ISO dimensions			Load ratings		Speed limits		Weight kg	Dim. rs min
Type	Version	d mm	D	B	C kN	Co kN	Grease r/min	Oil r/min		
6417		85	210	52	173	136	3200	3800	9	4
16017		85	130	14	33,8	33,5	5000	6000	0,63	1
61817		85	110	13	19,3	20	5300	6300	0,29	1
6018		90	140	24	58,2	49,7	4500	5300	1,16	1,5
6018	ZZ	90	140	24	58,2	49,7	4500		1,16	1,5
6018	2RS	90	140	24	58,2	49,7	3000		1,16	1,5
6218		90	160	30	96	71,5	3800	4500	2,16	2
6218	ZZ	90	160	30	96	71,5	3800		2,16	2
6218	2RS	90	160	30	96	71,5	3000		2,16	2
6318		90	190	43	143	107	3400	4000	4,9	3
6318	ZZ	90	190	43	143	107	3400		4,9	3
6418		90	225	54	190	160	3000	3600	11,5	4
16018		90	140	16	41,9	40,4	4500	5300	0,85	1
61818		90	115	13	19,6	20,4	5300	6300	0,3	1
6019		95	145	24	60,5	53,6	4300	5000	1,2	1,5
6019	ZZ	95	145	24	60,5	53,6	4300		1,2	1,5
6019	2RS	95	145	24	60,5	53,6	2800		1,2	1,5
6219		95	170	32	109	81,9	3600	4300	2,6	2,1
6219	ZZ	95	170	32	109	81,9	3600		2,6	2,1
6319		95	200	45	153	118	3200	3800	5,6	3
16019		95	145	16	42,3	41,5	4300	5000	0,89	1
6020		100	150	24	60,5	54	4300	5000	1,25	1,5
6020	ZZ	100	150	24	60,5	54	4300		1,25	1,5
6020	2RS	100	150	24	60,5	54	2800		1,25	1,5

Deep Groove Ball Bearings

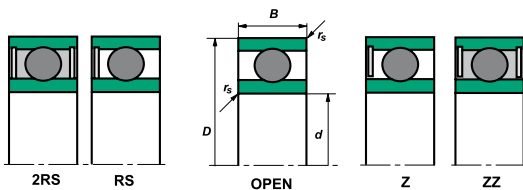

Bearing		ISO dimensions			Load ratings		Speed limits		Weight kg	Dim. rs min
Type	Version	d mm	D	B	C kN	Co kN	Grease r/min	Oil r/min		
6220		100	180	34	124	93	3400	4000	3,1	2,1
6220	ZZ	100	180	34	124	93	3400		3,1	2,1
6320		100	215	47	173	140	3000	3600	7	3
6320	ZZ	100	215	47	173	140	3000		7	3
16020		100	150	16	45	44	4300	5000	0,91	1
61820		100	125	13	19,6	21,2	4800	5600	0,32	1
6021		105	160	26	72,3	65,8	3800	4500	1,6	2
6021	ZZ	105	160	26	72,3	65,8	3800		1,6	2
6221		105	190	36	133	104	3200	3800	3,7	2,1
6321		105	225	49	184	153	2800	3400	8	3
16021		105	160	18	52	51	4000	4800	1,2	1
6022		110	170	28	82	73	3600	4300	1,95	2
6022	ZZ	110	170	28	82	73	3600		1,95	2
6222		110	200	38	143	118	3000	3600	4,35	2,1
6222	ZZ	110	200	38	143	118	3000		4,35	2,1
6322		110	240	50	203	178	2600	3200	9,58	3
6322	M	110	240	50	204,5	177,2	2400	3200	11,2	3
16022		110	170	19	57,5	56,7	3800	4500	1,46	1
61822		110	140	16	28,1	29	4300	5000	0,6	1
61922		110	150	20	40,6	42	3600	4500	0,84	1,1
6024		120	180	28	85	79,3	3400	4000	2,09	2
6024	ZZ	120	180	28	85	79,3	3400		2,09	2
6224		120	215	40	155	131	2800	3400	5,15	2,1
6224	ZZ	120	215	40	155	131	2800		5,15	2,1

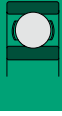

Bearing		ISO dimensions			Load ratings		Speed limits		Weight kg	Dim. rs min
Type	Version	d mm	D	B	C kN	Co kN	Grease r/min	Oil r/min		
6324		120	260	55	212	190	2400	3000	13,6	3
16034		120	180	19	63,2	63,3	3400	4000	1,7	1
61824		120	150	16	29,1	32,5	3800	4500	0,65	1
6026		130	200	33	106	101	3000	3600	3,25	2
6026	ZZ	130	200	33	106	101	3000		3,25	2
6226		130	230	40	167	146	2600	3200	6	3
6326		130	280	58	229	214	2200	2800	17	4
16026		130	165	18	38	43	3600	4300	0,93	1,1
61826		130	165	18	38	43	3600	4300	0,93	1,1
6028		140	210	33	110	109	2800	3400	3,35	2
6028	ZZ	140	210	33	110	109	2800		3,35	2
6228		140	250	42	176	164	2400	3000	7,5	3
6228	M	140	250	42	166	150	2400	300	9,44	3
6328		140	300	62	253	246	2000	2600	21	4
6328	M	140	300	62	273,5	272,5	2100	2500	21	4
16028		140	210	22	80,5	86	2800	3400	2,7	1,1
6030		150	225	35	125	126	2600	3200	4,75	2,1
6030	ZZ	150	225	35	125	126	2600		4,75	2,1
6230		150	270	45	176	170	2000	2600	9,6	3
6330		150	320	65	275	284	1900	2400	25	4
16030		150	225	24	92,3	98	2600	3200	3,4	1,1
61830		150	190	20	48,8	61	3000	3600	1,4	1,1
61930	M	150	210	28	84,5	90	2800	3400	3,04	2
6032		160	240	38	140	143	2400	3000	5,85	2,1

Deep Groove Ball Bearings

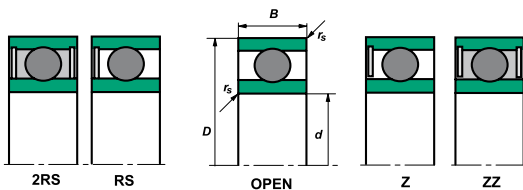

Bearing		ISO dimensions			Load ratings		Speed limits		Weight kg	Dim. rs min
Type	Version	d mm	D	B	C kN	Co kN	Grease r/min	Oil r/min		
6032	ZZ	160	240	38	140	143	2400		5,85	2,1
6232		160	290	48	185	186	1900	2400	15	3
6332	M	160	290	48	313	338,4	1900	2300	29,9	3
16032		160	240	25	99,4	107	2400	3000	3,6	1,5
61832		160	200	20	52	62	2800	3400	1,49	1,1
61932	M	160	220	28	90	95	2500	3100	3,15	2
6034		170	260	42	168	172	2200	2800	7,8	2,1
6234		170	310	52	227	240	1900	2400	15,2	4
6234	M	170	310	52	227	240	1900	2400	18,4	4
16034		170	260	28	118	127	2200	2800	5,7	1,5
6036		180	280	46	186	194	2000	2600	10,5	2,1
6236		180	320	52	227	242	1800	2200	18,5	4
16036	M	180	280	31	125	150	2000	2600	7,9	2
61836		180	225	22	62,3	78,5	2400	3000	2	1,1
61936		180	250	33	128	137	2200	2800	4,9	2
6038		190	290	46	194	210	2000	2600	11	2,1
6238		190	340	55	255	278	1700	2000	23	4
16038		190	290	31	148	162	2000	2600	7,9	2
61838		190	240	24	74,1	92	2200	2800	2,6	1,5
61840	M	200	250	24	72,3	84	2200	2800	2,68	1,5
61940	M	200	280	38	125	144	2000	2600	7,63	2,1
16040	M	200	310	34	160	179	1900	2400	10,3	2
6040	M	200	310	51	222	245	1900	2400	14,3	2,1
6240	M	200	360	58	288	335	1700	2000	24,4	4

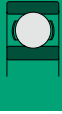

Bearing		ISO dimensions			Load ratings		Speed limits		Weight kg	Dim. rs min
Type	Version	d mm	D	B	C kN	Co kN	Grease r/min	Oil r/min		
61844	M	220	270	24	74,1	89	1900	2400	3,21	1,5
61944	M	220	300	38	175	162	1900	2400	7,96	2,1
16044		220	340	37	181	215	1800	2200	11,7	2,1
6044	M	220	340	56	245	293	1800	2200	18,8	3
6244		220	400	65	297	365	1500	1800	31,2	4
6344		220	460	88	403	520	1300	1600	71,4	5
6646	M	230	329,5	40	191	227	1600	2000	10,4	2,1
61848	M	240	300	28	103	116	1800	2200	4,78	2
61948	M	240	320	38	155	186	1800	2200	8,1	2,1
16048	M	240	360	37	188	228	1700	2000	15,8	2,1
6048	M	240	360	56	255	315	1700	2000	20,7	3
6248		240	440	72	360	470	1300	1600	51,8	4
61852	M	260	320	28	122	128	1700	2000	4,85	2
61952	M	260	360	46	212	269	1600	1900	14,4	2,1
16052	M	260	400	44	230	300	1500	1800	22	3
6052	M	260	400	65	294	375	1500	1800	28,8	4
61856	M	280	350	33	131	188	1600	1900	7,17	2
61956	M	280	380	46	215	282	1500	1800	15,6	2,1
16056		280	420	44	235	330	1300	1600	22,5	3
6056		280	420	65	305	405	1400	1700	32,2	4
6256		280	500	80	410	600	1000	1300	72	5
6356		280	580	108	560	840	1000	1200	141	6
61860	M	300	380	38	163	206	1400	1700	10,4	2,1
61960		300	420	56	267	370	1300	1600	20,7	3

Deep Groove Ball Bearings

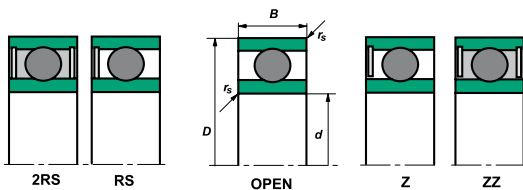

Bearing		ISO dimensions			Load ratings		Speed limits		Weight kg	Dim. rs min
Type	Version	d mm	D	B	C kN	Co kN	Grease r/min	Oil r/min		
6060		300	460	74	340	480	1200	1500	48,4	4
6260		300	540	85	450	665	950	1200	88	5
61864	M	320	400	38	164	220	1300	1600	11,4	2,1
60964		320	440	37	210	305	1200	1400	15,5	2,1
61964		320	440	56	278	395	1300	1600	24,9	3
16064		320	480	50	275	400	1100	1300	34	4
6064		320	480	74	355	510	1100	1400	50,3	4
6264		320	580	92	515	780	1000	1200	111	5
61868		340	420	38	169	227	1200	1500	11,6	2,1
61968		340	460	56	282	420	1100	1400	27	3
16068		340	520	57	335	520	950	1200	46	4
6068		340	520	82	403	620	1000	1300	63,4	5
6268		340	620	92	545	890	900	1000	112	6
6072	M	360	530	82	355	620	1000	1300	59,8	5
60872		360	440	25	118	210	1130	1450	6,5	1,5
61872	M	360	440	38	182	290	1100	1400	12,2	2,1
61972	M	360	480	56	282	425	1100	1400	30,2	3
16072		360	540	57	340	540	1000	1200	50	4
61876	MA	380	480	46	240	390	1000	1300	19	2,1
61976		380	520	65	345	550	1000	1300	39,8	4
16076		380	560	57	368	615	940	1100	50	4
60880		400	500	31	159	277	1000	1200	15	2
61880		400	500	46	242	403	1000	1200	21	2,1
60980		400	540	44	258	435	980	1250	27,5	3

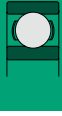

Bearing		ISO dimensions			Load ratings		Speed limits		Weight kg	Dim. rs min
Type	Version	d mm	D	B	C kN	Co kN	Grease r/min	Oil r/min		
61980	M	400	540	65	355	585	950	1200	43,6	4
6080		400	600	90	495	780	900	1100	87,9	5
61884		420	520	46	245	420	980	1250	21,5	2,1
61984	M	420	560	65	320	520	900	1100	46,2	4
6084		420	620	90	495	875	910	1110	90,5	5
60888		440	540	31	155	285	870	1000	16,5	2
61888		440	540	46	245	445	870	1000	22	2,1
60988		440	600	50	305	550	870	1000	41	4
6088		440	650	94	525	880	850	1000	108	6
61892	M	460	580	56	310	550	900	1100	34,3	3
61992		460	620	72	410	765	870	1100	63	4
61896		480	600	56	315	610	870	1100	36	3
6096	M	480	700	100	605	1130	740	900	126	6
608/500		500	620	37	220	445	800	950	20	2,1
618/500		500	620	56	330	620	800	950	37,3	3
619/500		500	670	78	450	860	760	900	79	5
60/500		500	720	100	575	1020	750	900	135	6
609/530		530	710	57	410	810	690	840	60	4
60/530	M	530	780	112	635	1260	670	810	188	6
608/560		560	680	37	220	460	710	860	30	2,1
618/560		560	680	56	328	525	700	850	42,7	3
608/600		600	730	42	260	550	670	800	41	3
618/600		600	730	60	345	710	670	800	52,7	3
608/630		630	780	48	355	765	640	760	41	3

Deep Groove Ball Bearings

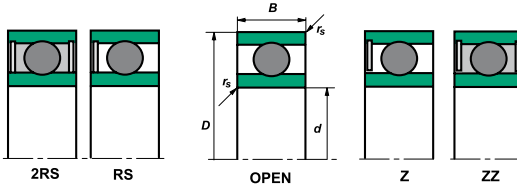

Bearing		ISO dimensions			Load ratings		Speed limits		Weight kg	Dim. rs min
Type	Version	d mm	D	B	C kN	Co kN	Grease r/min	Oil r/min		
609/630		630	850	71	475	1050	600	710	112	5
619/630		630	850	100	610	1330	600	710	163	6
60/630		630	920	128	800	1750	550	660	280	7,5
618/670		670	820	69	420	780	560	670	82,2	4
609/670		670	900	73	540	1210	580	700	143	5
619/670	M	670	900	103	670	1450	530	630	194	6
618/710		710	870	74	451	905	530	630	98,1	4
609/710		710	950	78	545	1280	500	610	148	5
619/710		710	950	106	645	1510	500	610	218	6
60/710		710	1030	140	935	2180	490	560	375	7,5
618/750		750	920	78	515	1240	480	610	110	5
619/750		750	1000	112	745	1790	490	570	260	6
60/750		750	1090	150	975	2370	450	530	490	7,5
608/800		800	980	57	390	990	430	510	100	4
618/800		800	980	82	545	1360	430	510	132	5
619/800		800	1060	115	815	2100	430	500	280	6
60/800		800	1150	155	985	2530	400	480	540	7,5
608/850		850	1030	57	385	1000	450	500	75	4
618/850		850	1030	82	555	1310	450	530	144	5
619/850		850	1120	118	815	2150	400	480	315	6
60/850		850	1220	165	1090	2980	370	430	640	7,5
618/900	CA	900	1090	85	600	1430	380	450	155	5
619/900		900	1180	122	830	2270	360	440	355	6
60/900		900	1280	170	1080	3120	330	410	725	7,5

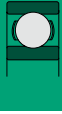

Bearing		ISO dimensions			Load ratings		Speed limits		Weight kg	Dim. rs min
Type	Version	d mm	D	B	C kN	Co kN	Grease r/min	Oil r/min		
619/950		950	1250	132	985	2850	330	410	395	7,5
60/950		950	1360	180	1145	3315	310	380	850	7,5
608/1000		1000	1220	71	540	1550	350	400	175	5
609/1000		1000	1320	103	800	2340	330	380	405	6
619/1000		1000	1320	140	985	2880	330	380	525	7,5
60/1000		1000	1420	185	1320	3900	280	340	925	7,5
618/1060		1060	1280	100	710	2140	310	350	265	6
619/1060		1060	1400	150	985	3030	290	330	615	7,5
60/1060		1060	1500	195	1320	3860	250	330	1090	9,5
618/1120		1120	1360	106	725	2180	290	350	310	6
619/1120		1120	1460	150	1010	3070	270	330	640	7,5
60/1120		1120	1580	200	1430	4480	250	300	1245	9,5
619/1180		1180	1540	160	1115	3630	210	270	765	7,5
618/1250		1250	1500	112	830	2740	210	270	390	6
609/1320		1320	1720	128	1180	4060	190	230	835	7,5
618/1400		1400	1700	132	1070	3980	190	230	620	7,5
619/1400		1400	1820	185	1550	5520	180	230	1260	9,5
618/1500		1500	1820	140	1190	4310	170	210	695	7,5
619/1500		1500	1950	195	1680	6220	160	190	1515	9,5
618/1600		1600	1950	155	1240	4750	150	180	975	7,5
619/1600		1600	2060	200	1820	6880	140	170	1660	9,5
618/1700		1700	2060	160	1240	4950	130	160	1110	7,5
619/1700		1700	2180	212	1950	7680	120	150	1930	9,5

Deep Groove Ball Bearings Stainless Steel

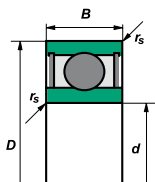

Bearing		ISO dimensions			Load ratings		Speed limits	Weight	Dim.
Type	Version	d mm	D	B	C kN	Co kN	Grease r/min	kg	rs min
S685	2RS	5	11	3	0,72	0,28	43000	0,0011	0,15
S695	2RS	5	13	4	1,08	0,43	40000	0,0024	0,20
S605	2RS	5	14	5	1,33	0,51	39000	0,0035	0,20
S625	2RS	5	16	5	1,76	0,68	37000	0,0048	0,30
S635	2RS	5	19	6	2,34	0,89	34000	0,0080	0,30
S686	2RS	6	13	4	1,08	0,44	39000	0,0019	0,15
S696	2RS	6	15	5	1,35	0,53	37000	0,0038	0,20
S606	2RS	6	17	6	2,19	0,87	35000	0,0060	0,30
S626	2RS	6	19	6	2,34	0,89	34000	0,0080	0,30
S636	2RS	6	22	7	3,30	1,35	31000	0,0130	0,30
S687	2RS	7	14	4	1,17	0,51	37000	0,0021	0,15
S697	2RS	7	17	5	1,61	0,72	35000	0,0052	0,30
S607	2RS	7	19	6	2,24	0,91	34000	0,0080	0,30
S627	2RS	7	22	7	3,35	1,40	32000	0,0130	0,30
S637	2RS	7	26	9	4,55	1,95	26000	0,0240	0,30
S688	2RS	8	16	4	1,26	0,59	35000	0,0031	0,20
S698	2RS	8	19	6	1,99	0,87	33000	0,0073	0,30
S608	2RS	8	22	7	3,35	1,40	32000	0,0120	0,30
S628	2RS	8	24	8	4,00	1,59	31000	0,0170	0,30
S638	2RS	8	28	9	4,55	1,95	26000	0,0290	0,30
S689	2RS	9	17	4	1,72	0,82	33000	0,0032	0,20
S699	2RS	9	20	6	2,48	1,09	32000	0,0082	0,30
S609	2RS	9	24	7	3,40	1,45	31000	0,0140	0,30
S629	2RS	9	26	8	4,55	1,96	30000	0,0200	0,30

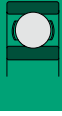

Bearing		ISO dimensions			Load ratings		Speed limits	Weight	Dim.
Type	Version	d mm	D	B	C kN	Co kN	Grease r/min	kg	rs min
S639	2RS	9	30	10	6,00	2,65	24000	0,0350	0,30
S6000	2RS	10	26	8	4,55	1,96	29000	0,0190	0,30
S6200	2RS	10	30	9	5,10	2,39	25000	0,0320	0,60
S6300	2RS	10	35	11	8,20	3,50	23000	0,0530	0,60
S6800	2RS	10	19	5	1,83	0,93	32000	0,0050	0,30
S6900	2RS	10	22	6	2,70	1,27	30000	0,0090	0,30
S6001	2RS	12	28	8	5,10	2,39	26000	0,0210	0,30
S6201	2RS	12	32	10	6,10	2,75	22000	0,0370	0,60
S6301	2RS	12	37	12	9,70	4,20	20000	0,0600	1,00
S6801	2RS	12	21	5	1,92	1,04	29000	0,0060	0,30
S6901	2RS	12	24	6	2,89	1,46	27000	0,0110	0,30
S6002	2RS	15	32	9	5,60	2,84	22000	0,0300	0,30
S6202	2RS	15	35	11	7,75	3,60	19000	0,0450	0,60
S6302	2RS	15	42	13	11,40	5,45	17000	0,0820	1,00
S6802	2RS	15	24	5	2,08	1,26	26000	0,0070	0,30
S6902	2RS	15	28	7	4,10	2,06	24000	0,0160	0,30
S6003	2RS	17	35	10	6,80	3,35	20000	0,0390	0,30
S6203	2RS	17	40	12	9,60	4,60	18000	0,0660	0,60
S6303	2RS	17	47	14	13,50	6,55	16000	0,1150	1,00
S6803	2RS	17	26	5	2,81	1,72	24000	0,0080	0,30
S6903	2RS	17	30	7	4,65	2,58	22000	0,0180	0,30
S6004	2RS	20	42	12	9,40	5,05	18000	0,0690	0,60
S6204	2RS	20	47	14	12,80	6,65	16000	1,1060	1,00
S6304	2RS	20	52	15	15,90	7,90	14000	0,1440	1,10

Deep Groove Ball Bearings Stainless Steel

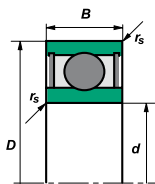

Bearing		ISO dimensions			Load ratings		Speed limits	Weight	Dim. rs
Type	Version	d mm	D	B	C kN	Co kN	Grease r/min	kg	rs min
S6804	2RS	20	32	7	4,00	2,47	21000	0,0190	0,30
S6904	2RS	20	37	9	6,40	3,70	19000	0,0360	0,30
S6005	2RS	25	47	12	10,10	5,85	15000	0,0800	0,60
S6205	2RS	25	52	15	14,00	7,85	13000	0,1280	1,00
S6305	2RS	25	62	17	21,20	10,90	12000	0,2320	1,10
S6805	2RS	25	37	7	4,30	2,95	18000	0,0220	0,30
S6905	2RS	25	42	9	7,05	4,55	16000	0,0420	0,30
S6006	2RS	30	55	13	13,20	8,30	13000	0,1160	1,00
S6206	2RS	30	62	16	19,50	11,30	11000	1,1990	1,00
S6306	2RS	30	72	19	26,70	15,00	10000	0,3500	1,10
S6806	2RS	30	42	7	4,70	3,65	15000	0,0260	0,30
S6906	2RS	30	47	9	7,25	5,00	14000	0,0480	0,30
S6007	2RS	35	62	14	16,00	10,30	12000	0,1550	1,00
S6207	2RS	35	72	17	25,70	15,30	9800	0,2880	1,10
S6307	2RS	35	80	21	33,50	19,10	8800	0,4570	1,50
S6807	2RS	35	47	7	4,90	4,05	13000	0,0290	0,30
S6907	2RS	35	55	10	11,20	7,45	12000	0,0740	0,60
S6008	2RS	40	68	15	16,80	11,50	10000	0,1900	1,00
S6208	2RS	40	80	18	29,10	17,80	8700	3,3660	1,10
S6308	2RS	40	90	23	40,50	24,00	7800	0,6300	1,50
S6808	2RS	40	52	7	5,10	4,40	12000	0,0330	0,30
S6908	2RS	40	62	12	14,60	10,20	11000	0,1100	0,60
S6009	2RS	45	75	16	21,00	15,10	9200	0,2370	1,00
S6209	2RS	45	85	19	32,50	20,40	7800	0,3980	1,10

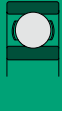

Bearing		ISO dimensions			Load ratings		Speed limits	Weight	Dim.
Type	Version	d mm	D	B	C kN	Co kN	Grease r/min	kg	rs min
S6309	2RS	45	100	25	53,00	32,00	7000	0,8140	1,50
S6809	2RS	45	58	7	6,40	5,65	11000	0,0400	0,30
S6909	2RS	45	68	12	15,10	11,20	9800	0,1280	0,60
S6010	2RS	50	80	16	21,80	16,60	8400	0,2610	1,00
S6210	2RS	50	90	20	35,00	23,20	7100	0,4540	1,10
S6310	2RS	50	110	27	62,00	38,50	6400	1,0700	2,00
S6810	2RS	50	65	7	6,60	6,10	9600	0,0520	0,30
S6910	2RS	50	72	12	15,60	12,20	8900	0,1320	0,60
S6011	2RS	55	90	18	28,30	21,20	7700	0,3880	1,10
S6211	2RS	55	100	21	43,50	29,20	6400	0,6010	1,50
S6311	2RS	55	120	29	71,50	45,00	5800	1,3700	2,00
S6811	2RS	55	72	9	8,80	8,10	8700	0,0830	0,30
S6911	2RS	55	80	13	16,00	13,30	8200	0,1800	1,00
S6012	2RS	60	95	18	29,50	23,20	7000	0,4140	1,10
S6212	2RS	60	110	22	52,50	36,00	6000	0,7830	1,50
S6812	2RS	60	78	10	11,50	10,60	8000	0,1060	0,30
S6912	2RS	60	85	13	16,40	14,30	7600	0,1930	1,00
S6013	2RS	65	100	18	30,50	25,20	6500	0,4210	1,10
S6213	2RS	65	120	23	57,50	40,00	5500	0,9900	1,50
S6813	2RS	65	95	10	11,60	11,00	7400	0,1280	0,60
S6913	2RS	65	90	13	17,40	16,10	7000	0,2060	1,00
S6014	2RS	70	110	20	38,00	31,00	6100	0,6040	1,10
S6814	2RS	70	90	10	12,10	11,90	6900	0,1370	0,60
S6914	2RS	70	100	16	23,70	21,20	6500	0,3340	1,00

Deep Groove Ball Bearings Stainless Steel

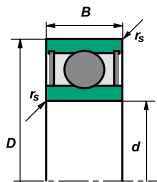

Bearing		ISO dimensions			Load ratings		Speed limits	Weight	Dim.
Type	Version	d mm	D	B	C kN	Co kN	Grease r/min	kg	rs min
S6815	2RS	75	95	10	12,50	12,90	6400	0,1450	0,60
S6915	2RS	75	105	16	24,40	22,60	6100	0,3530	1,00
S6816	2RS	80	100	10	12,70	13,30	6000	0,1540	0,60
S6916	2RS	80	110	16	24,90	24,00	5700	0,3730	1,00

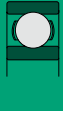



SELF-ALIGNING BALL BEARINGS

Dimensions in accordance with ISO 15-2008

Self-aligning ball bearings have two rows of balls, located on the inner ring and a spherical outer track. This design permits misalignment of the inner and outer races caused, for example, by shaft deflection or variation in housing alignment.

These bearings are also manufactured with tapered bore for use with adapter sleeves.

Misalignment

Maximum permitted misalignment in degrees.

Bearing series	Maximum inclination in degrees
108, 126, 127, 129, 135	3°
Series 12	2.5°
Series 13	3°
Series 22	2.5°
Series 22-2RS	1.5°
Series 23	3°
Series 23-2RS	1.5°

Self-aligning ball bearings with cylindrical and tapered bore

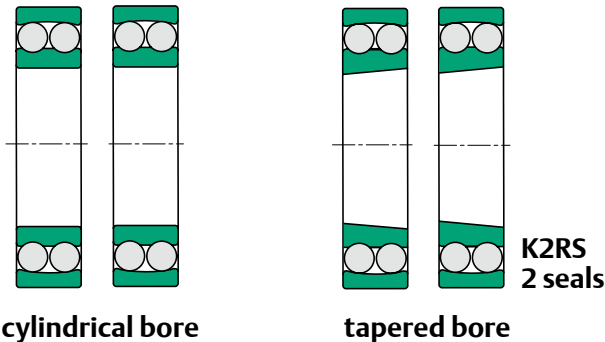

Self-aligning ball bearings with adapter sleeve tapered bore

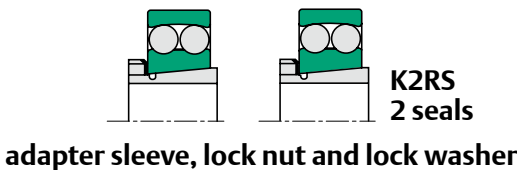

Self Aligning Ball Bearings

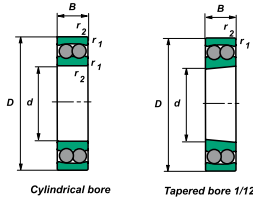

Bearing		ISO dimensions			Load ratings		Speed limits		Weight	Dim.	Calculation factors			
Type	Version	d mm	D	B	C kN	Co kN	Grease r/min	Oil r/min	kg	r _{1,2} min	e	Y1	Y2	Y0
135		5	19	6	2,55	0,48	30000	36000	0,01	0,3	0,33	1,9	3	2
126		6	19	6	2,5	0,48	30000	36000	0,01	0,3	0,33	1,9	3	2
127		7	22	7	2,65	0,56	30000	36000	0,01	0,3	0,33	1,9	3	2
108		8	22	7	2,65	0,56	30000	36000	0,01	0,3	0,33	1,9	3	2
129		9	26	8	3,8	0,8	26000	32000	0,02	0,6	0,33	1,9	3	2
1200		10	30	9	5,5	1,2	24000	30000	0,03	0,6	0,33	1,9	3	2
1300		10	35	11	7,2	1,6	20000	26000	0,62	0,6	0,34	1,9	2,9	1,9
2200		10	30	14	7,2	1,6	22000	28000	0,04	0,6	0,54	1,2	1,8	1,2
1201		12	32	10	5,6	1,25	22000	28000	0,04	0,6	0,37	1,7	2,6	1,8
1301		12	37	12	9,4	2,15	18000	22000	0,06	1	0,35	1,8	2,8	1,9
2201		12	32	14	7,6	1,75	20000	26000	0,05	0,6	0,53	1,2	1,8	1,2
2301		12	37	17	9,4	2,3	17000	20000	0,09	1	0,54	1,2	1,8	1,2
1202		15	35	11	7,5	1,75	19000	24000	0,04	0,6	0,36	1,8	2,7	1,9
1302		15	42	13	9,55	2,3	17000	20000	0,09	1	0,35	1,8	2,8	1,9
2202		15	35	14	7,7	1,85	18000	22000	0,06	0,6	0,5	1,3	2	1,3
2302		15	42	17	12,1	2,9	15000	18000	0,11	1	0,5	1,3	2	1,3
1203		17	40	12	7,9	2,05	18000	22000	0,07	0,6	0,32	1,9	3	2
1303		17	47	14	12,5	3,15	14000	17000	0,13	1	0,34	1,8	2,9	2
2203		17	40	16	9,8	2,4	17000	20000	0,08	0,6	0,5	1,3	2	1,3
2303		17	47	19	14,5	3,6	13000	16000	0,16	1	0,49	1,3	2	1,3
1204		20	47	14	9,9	2,65	15000	18000	0,120	1,0	0,28	2,2	3,5	2,4
1304		20	52	15	12,4	3,35	12000	15000	0,160	1,1	0,30	2,1	3,3	2,2
2204		20	47	18	12,6	3,30	14000	17000	0,140	1,0	0,28	2,2	3,5	2,4
2304		20	52	21	18,2	4,70	11000	14000	0,210	1,1	0,52	1,2	1,9	1,3



Bearing		ISO dimensions			Load ratings		Speed limits		Weight	Dim.	Calculation factors			
Type	Version	d mm	D	B	C kN	Co kN	Grease r/min	Oil r/min	kg	r _{1,2} min	e	Y1	Y2	Y0
1205		25	52	15	12,2	3,30	13000	16000	0,140	1,0	0,29	2,2	3,4	2,3
1305		25	62	17	17,8	4,90	9500	12000	0,260	1,1	0,28	2,2	3,5	2,4
2205	2RS	25	52	18	12,2	3,30	7000		0,160	1,0	0,29	2,2	3,4	2,3
2205		25	52	18	12,5	3,45	11000	14000	0,160	1,0	0,43	1,5	2,3	1,6
2305	2RS	25	62	24	17,8	4,90	6300		0,330	1,1	0,28	2,2	3,5	2,4
2305		25	62	24	24,5	6,55	9500	12000	0,340	1,1	0,44	1,4	2,2	1,5
1206		30	62	16	15,7	4,70	10000	13000	0,220	1,0	0,25	2,5	3,9	2,7
1306		30	72	19	21,4	6,35	9000	11000	0,380	1,1	0,24	2,6	4,1	2,8
2206	2RS	30	62	20	15,7	4,70	5300		0,260	1,0	0,25	2,5	3,9	2,7
2206		30	62	20	15,3	4,60	9500	12000	0,260	1,0	0,40	1,6	2,5	1,7
2306	2RS	30	72	27	21,4	6,35	5600		0,500	1,1	0,24	2,6	4,1	2,8
2306		30	72	27	31,4	8,70	8500	10000	0,500	1,1	0,40	1,6	2,5	1,7
1207		35	72	17	15,8	5,15	9000	11000	0,320	1,1	0,23	2,8	4,2	2,9
1307		35	80	21	25,1	7,95	7500	9000	0,510	1,5	0,25	2,5	3,9	2,7
2207	2RS	35	72	23	15,8	5,15	5600		0,400	1,1	0,23	2,8	4,2	2,9
2207		35	72	23	21,7	6,70	8500	10000	0,400	1,1	0,37	1,7	2,6	1,8
2307	2RS	35	80	31	25,1	7,95	4500		0,670	1,5	0,25	2,5	3,9	2,7
2307		35	80	31	39,7	12,90	7000	8500	0,670	1,5	0,43	1,5	2,3	1,6
1208		40	80	18	19,2	6,50	8500	10000	0,410	1,1	0,22	2,9	4,5	3,0
1308		40	90	23	29,5	9,75	6700	8000	0,710	1,5	0,24	2,6	4,1	2,8
2208	2RS	40	80	23	19,2	6,50	4800		0,500	1,1	0,22	2,9	4,5	3,0
2208		40	80	23	22,4	7,40	7500	9000	0,500	1,1	0,33	1,9	3,0	2,0
2308	2RS	40	90	33	29,5	9,75	4000		0,920	1,5	0,24	2,6	4,1	2,8
2308		40	90	33	44,9	15,10	6300	7500	0,920	1,5	0,39	1,6	2,5	1,7

Self Aligning Ball Bearings

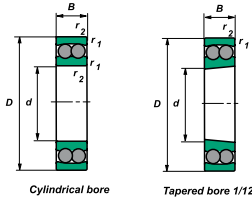

Bearing		ISO dimensions			Load ratings		Speed limits		Weight	Dim.	Calculation factors			
Type	Version	d mm	D	B	C kN	Co kN	Grease r/min	Oil r/min	kg	r _{1,2} min	e	Y1	Y2	Y0
1209		45	85	19	21,8	7,40	7500	9000	0,460	1,1	0,21	3,0	4,7	3,2
1309		45	100	25	37,7	12,90	6300	7500	0,950	1,5	0,24	2,6	4,1	2,8
2209	2RS	45	85	23	21,8	7,40	4500		0,540	1,1	0,21	3,0	4,7	3,2
2209		45	85	23	23,3	8,15	7000	8500	0,540	1,1	0,31	2,0	3,1	2,1
2309	2RS	45	100	36	37,7	12,90	3600		1,230	1,5	0,24	2,6	4,1	2,8
2309		45	100	36	54,1	16,50	5600	6700	1,230	1,5	0,31	2,0	3,1	2,1
1210		50	90	20	22,9	8,10	7000	8500	0,520	1,1	0,21	3,0	4,7	3,2
1310		50	110	27	43,4	14,20	5600	6700	1,210	2,0	0,24	2,6	4,1	2,8
2210	2RS	50	90	23	22,9	8,10	4000		0,590	1,1	0,21	3,0	4,6	3,2
2210		50	90	23	23,3	8,50	6300	7500	0,590	1,1	0,29	2,2	3,4	2,3
2310	2RS	50	110	40	43,4	14,20	3400		1,640	2,0	0,24	2,6	4,1	2,8
2310		50	110	40	64,4	20,00	5300	6300	1,230	2,0	0,42	1,5	2,3	1,6
1211		55	100	21	26,6	10,10	6300	7500	0,700	1,5	0,20	3,2	4,9	3,3
1311		55	120	29	51,3	18,10	5000	6000	1,580	2,0	0,23	2,3	4,2	2,9
2211		55	100	25	26,5	9,90	6000	7000	0,810	1,5	0,27	2,3	3,6	2,5
2311		55	120	43	75,3	23,80	4800	5600	2,100	2,0	0,41	1,5	2,4	1,6
1212		60	110	22	30,2	11,60	5600	6700	0,900	1,5	0,19	3,4	5,2	3,5
1312		60	130	31	57,1	20,80	4500	5300	1,960	2,1	0,23	2,8	4,2	2,9
2212		60	110	28	33,8	12,60	5300	6300	1,100	1,5	0,28	2,2	3,5	2,4
2312		60	130	46	87,1	28,00	4300	5000	2,600	2,1	0,41	1,5	2,4	1,6
1213		65	120	23	31,0	12,40	5300	6300	1,150	1,5	0,17	3,7	5,7	3,9
1313		65	140	33	62,0	22,90	4300	5000	2,450	2,1	0,23	2,8	4,2	2,8
2213		65	120	31	43,6	16,40	5000	6000	1,450	1,5	0,28	2,2	3,5	2,4
2313		65	140	48	95,6	32,50	4000	4800	3,250	2,1	0,38	1,7	2,6	1,7



Bearing		ISO dimensions			Load ratings		Speed limits		Weight	Dim.	Calculation factors			
Type	Version	d mm	D	B	C kN	Co kN	Grease r/min	Oil r/min	kg	r1,2 min	e	Y1	Y2	Y0
1214		70	125	24	34,6	13,70	5000	6000	1,250	1,5	0,18	3,5	5,4	3,7
1314		70	150	35	74,1	27,70	4000	4800	3,000	2,1	0,22	2,9	4,5	3,0
2214		70	125	31	44,2	17,10	4800	5600	1,500	1,5	0,27	2,3	3,6	2,5
2314		70	150	51	111,0	31,70	3600	4300	3,900	2,1	0,35	1,8	2,8	1,9
1215		75	130	25	38,9	15,60	4800	5600	1,350	1,5	0,18	3,5	5,4	3,7
1315		75	160	37	79,2	30,00	3600	4300	3,550	2,1	0,22	2,9	4,5	3,0
2215		75	130	31	44,0	17,80	4500	5300	1,600	1,5	0,25	2,5	3,9	2,7
2315		75	160	55	123,0	42,80	3400	4000	4,700	2,1	0,38	1,7	2,6	1,7
1216		80	140	26	39,8	17,00	4300	5000	1,650	2,0	0,16	3,9	6,1	4,1
1316		80	170	39	88,4	33,00	3400	4000	4,200	2,1	0,22	2,9	4,5	3,0
2216		80	140	33	48,8	19,90	4000	4800	2,000	2,0	0,26	2,4	3,7	2,5
2316		80	170	58	136,0	48,50	3200	3800	6,100	2,1	0,34	1,9	2,9	2,0
1217		85	150	28	48,2	20,80	4000	4800	2,050	2,0	0,17	3,7	5,7	3,9
1317		85	180	41	97,5	37,90	3200	4800	5,000	3,0	0,22	2,9	4,5	3,0
2217		85	150	36	58,5	23,80	3800	4800	2,500	2,0	0,25	2,5	3,9	2,7
2317		85	180	60	140,0	51,50	3000	3600	7,050	3,0	0,37	1,7	2,6	1,8
1218		90	160	30	57,0	23,10	3800	4500	2,500	2,0	0,17	3,7	5,7	3,9
1318		90	190	43	117,0	44,50	3000	3600	5,800	3,0	0,22	2,9	4,5	3,0
2218		90	160	40	70,2	27,20	3600	4300	3,400	2,0	0,27	2,3	3,6	2,5
2318		90	190	64	153,0	57,70	2800	3400	8,450	3,0	0,38	1,7	2,6	1,7
1219		95	170	32	63,7	24,30	3400	4000	3,100	2,1	0,17	3,7	5,7	3,9
1319		95	200	45	133,0	50,80	2800	3400	6,700	3,0	0,23	2,8	4,2	2,9
1220		100	180	34	68,9	29,70	3200	3800	3,700	2,1	0,17	3,7	5,7	3,9
1320		100	215	47	143,0	57,30	2600	3200	8,300	3,0	0,24	2,6	4,1	2,8

Self Aligning Ball Bearings

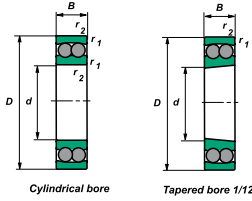

Bearing		ISO dimensions			Load ratings		Speed limits		Weight	Dim.	Calculation factors			
Type	Version	d mm	D	B	C kN	Co kN	Grease r/min	Oil r/min	kg	r _{1,2} min	e	Y1	Y2	Y0
2220		100	180	46	97,5	34,00	3200	3800	5,000	2,1	0,24	2,6	4,1	2,8
2320		100	215	73	193,0	73,40	2400	3000	12,200	3,0	0,34	1,9	2,9	2,0
1222		110	200	38	88,0	35,20	2800	3400	5,150	2,1	0,17	3,7	5,7	3,9
1322		110	240	50	163,0	67,50	2400	3000	12,000	3,0	0,22	2,9	4,5	3,0
2222		110	200	53	124,0	48,90	2800	3400	7,100	2,1	0,26	2,4	3,7	2,5





ANGULAR CONTACT BEARINGS

Dimensions in accordance with ISO 15-2008

Single row angular contact ball bearings are designed especially to carry combination radial and single direction thrust loads. To carry thrust loads from opposing directions, these bearings are frequently mounted in duplex pairs with the contact angles opposed. Angular contact bearings can be mounted in a variety of ways, for example “face to face” and “tandem”, as illustrated below.

Bearings are also available with universally flush ground side surfaces of the inner and outer rings for duplex mountings. Flush ground bearings are available in different preloads to give axial rigidity. Angular contact bearings are offered in extra light, light, and medium series. Each series is available in 15, 25, and 40 contact angles to fulfill a wide variety of applications. A higher contact angle increases thrust capacity and axial rigidity, but reduces radial capacity and radial rigidity. Pressed steel, machined bronze, and phenolic cages are available to meet a variety of speed and duty requirements.



SINGLE ROW ANGULAR CONTACT BALL BEARINGS

Series 72 B, 73 B
Contact angle

$\alpha = 40^\circ$



Series 70 A, 72 A
Contact angle

$\alpha = 25^\circ$



Series 70 C, 72 C
Contact angle

$\alpha = 15^\circ$



DT arrangement
(tandem)

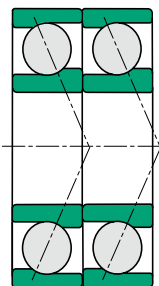

DB arrangement
(back to back)

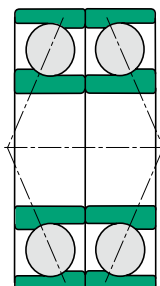

DF arrangement
(face to face)

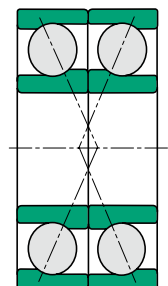

Single Row Angular Contact Ball Bearings

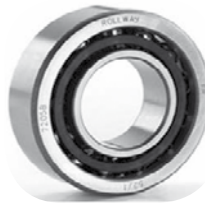
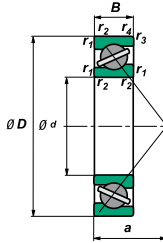

Bearing		Type			Load ratings		Speed limits		Weight	Dimensions		
Type	Version	d mm	D	B	C kN	Co kN	Grease r/min	Oil r/min	kg	r1,2 min	r3,4 min	a
7200	B	10	30	9	4,95	2,5	19000	28000	0,031	0,6	0,3	13
7201	B	12	32	10	7,4	3,75	17000	24000	0,045	0,6	0,3	14
7202	B	15	35	11	7,45	3,9	16000	22000	0,048	0,6	0,3	16
7302	B	15	42	13	12,90	6,5	14000	19000	0,090	1,0	0,6	19
7203	B	17	40	12	9,9	5,5	14000	19000	0,065	0,6	0,3	18
7203	B TN	17	40	12	9,9	5,5	14000	19000	0,065	0,6	0,3	18
7303	B	17	47	14	14,8	8,1	12000	17000	0,120	1,0	0,6	21
7204	B	20	47	14	14,1	8,4	11000	16000	0,110	1,0	0,6	21
7304	B	20	52	15	17,3	9,7	10000	15000	0,150	1,1	0,6	23
7205	B	25	52	15	15,5	10,1	9500	14000	0,130	1,0	0,6	24
7305	B	25	62	17	24,4	14,6	8500	12000	0,250	1,1	0,6	27
7206	B	30	62	16	20,5	13,6	8500	12000	0,210	1,0	0,6	27
7306	B	30	72	19	29,3	19,0	7500	10000	0,370	1,1	0,6	31
7207	B	35	72	17	28,5	19,8	7500	10000	0,300	1,1	0,6	31
7307	B	35	80	21	36,7	24,3	7000	9500	0,510	1,5	1,0	35
7208	B	40	80	18	32,1	23,0	6700	9000	0,390	1,1	0,6	34
7308	B	40	90	23	44,8	30,3	6300	8500	0,670	1,5	1,0	39
7209	B	45	85	19	36,1	26,2	6300	8500	0,440	1,1	0,6	37
7309	B	45	100	25	58,3	40,1	5600	7500	0,900	1,5	1,0	43
7210	B	50	90	20	37,4	28,6	5600	7500	0,490	1,1	0,6	39
7310	B	50	110	27	68,2	47,9	5000	6700	1,150	2,0	1,0	47
7211	B	55	100	21	46,2	36,2	5300	7000	0,650	1,5	1,0	43
7311	B	55	120	29	78,8	56,4	4500	6000	1,450	2,0	1,0	52
7212	B	60	110	22	56,3	44,7	4800	6300	0,840	1,5	1,0	47
7312	B	60	130	31	90,0	65,5	4300	5600	1,850	2,1	1,1	56



Bearing		Type			Load ratings		Speed limits		Weight	Dimensions		
Type	Version	d mm	D	B	C kN	Co kN	Grease r/min	Oil r/min	kg	r1,2 min	r3,4 min	a
7213	B	65	120	23	63,6	52,5	4300	5600	1,050	1,5	1,0	50
7313	B	65	140	33	101,0	75,3	4000	5300	2,250	2,1	1,1	60
7214	B	70	125	24	69,1	57,8	4300	5600	1,150	1,5	1,0	53
7314	B	70	150	35	114,0	86,0	3800	5000	2,750	2,1	1,1	64
7215	B	75	130	25	74,8	63,2	4000	5300	1,300	1,5	1,0	56
7315	B	75	160	37	125,0	97,5	3400	4500	3,300	2,1	1,1	68
7216	B	80	140	26	80,5	69,3	3800	5000	1,550	2,0	1,0	59
7316	B	80	170	39	135,0	109,0	3200	4300	3,900	2,1	1,1	72
7217	B	85	150	28	93,1	81,1	3400	4500	1,950	2,0	1,0	64
7317	B	85	180	41	145,0	122,0	3000	4000	4,600	3,0	1,1	76
7218	B	90	160	30	107,0	93,8	3200	4300	2,400	2,0	1,0	67
7318	B	90	190	43	156,0	135,0	2800	3800	5,400	3,0	1,1	80
7219	B	95	170	32	116,0	101,0	3000	4000	2,900	2,1	1,1	71
7319	B	95	200	45	168,0	150,0	2600	3600	6,250	3,0	1,1	84
7220	B	100	180	34	129,0	116,0	2800	3800	3,450	2,1	1,1	76
7320	B	100	215	47	190,0	178,0	2400	3400	7,750	3,0	1,1	90
7222	B	110	200	38	153,0	145,0	2400	3400	4,800	2,1	1,1	84
7322	B	110	240	50	248,0	229,0	2000	3000	10,500	3,0	1,1	99
7328	B	140	300	62	290,0	334,0	1700	2400	21,600	4,0	1,5	123

Double Rows Angular Contact Ball Bearings

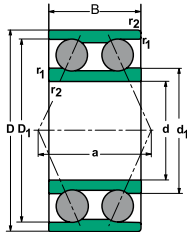

Bearing		ISO dimensions			Load ratings		Speed limits		Weight	Dimensions	
Type	Version	d mm	D	B	C kN	Co kN	Grease r/min	Oil r/min	kg	r1,2 min	a
3200		10	30	14,3	7,8	3,9	16000	22000	0,05	0,6	19
3201		12	32	15,9	10,6	5,1	15000	20000	0,06	0,6	22
3202		15	35	15,9	11,8	6,1	13000	18000	0,07	0,6	23
3302		15	42	19	16,3	8,7	10000	15000	0,13	1	27
3203		17	40	17,5	14,6	7,8	10000	15000	0,1	0,6	27
3303		17	47	22,2	20,8	10,6	9500	14000	0,19	1	31
3204		20	47	20,6	19,6	10,8	9000	13000	0,170	1,0	31
3304		20	52	22,2	23,2	12,9	8500	12000	0,230	1,1	34
3205		25	52	20,6	21,2	12,7	8000	11000	0,190	1,0	35
3305		25	62	25,4	29,2	17,3	7500	10000	0,370	1,1	40
3206		30	62	23,8	28,1	18,3	7000	9500	0,310	1,0	41
3306		30	72	30,2	38,0	24,5	6300	8500	0,580	1,1	47
3207		35	72	27,0	39,0	25,0	6000	8000	0,480	1,1	47
3307		35	80	34,9	51,0	30,0	5600	7500	0,780	1,5	54
3208		40	80	30,2	48,0	31,5	5600	7500	0,650	1,1	52
3308		40	90	36,5	62,0	39,0	5000	6700	1,050	1,5	58
3209		45	85	30,2	49,0	32,5	5000	6700	0,700	1,1	56
3309		45	100	39,7	71,0	57,0	4500	6000	1,410	1,5	64
3210		50	90	30,2	51,0	36,0	4800	6300	0,740	1,1	59
3310		50	110	44,4	85,0	75,0	4000	5300	1,900	2,0	73
3211		55	100	33,3	54,0	55,0	4300	5600	1,050	1,5	64
3311		55	120	49,2	98,0	88,0	3600	4800	2,480	2,0	80
3212		60	110	36,5	69,5	72,0	3800	5000	1,360	1,5	71



Bearing		ISO dimensions			Load ratings		Speed limits		Weight	Dimensions	
Type	Version	d mm	D	B	C kN	Co kN	Grease r/min	Oil r/min	kg	r1,2 min	a
3312		60	130	54,0	114,0	112,0	3400	4500	3,170	2,1	86
3213		65	120	38,1	73,5	83,0	3600	4800	1,760	1,5	76
3313		65	140	58,7	129,0	130,0	3200	4300	4,010	2,1	94
3214		70	125	39,7	81,5	91,5	3200	4300	1,930	1,5	81
3314		70	150	63,5	143,0	146,0	2800	3800	5,040	2,1	101
3215		75	130	41,3	85,0	98,0	3200	4300	2,080	1,5	84
3315		75	160	68,3	163,0	166,0	2600	3600	6,160	2,1	107
3216		80	140	44,4	95,0	110,0	2800	3800	2,640	2,0	91
3316		80	170	68,3	176,0	186,0	2400	3400	6,930	2,1	112
3217		85	150	49,2	112,0	132,0	2600	3600	3,390	2,0	97
3317		85	180	73,0	190,0	200,0	2200	3200	8,300	3,0	119
3218		90	160	52,4	125,0	146,0	2400	3400	4,140	2,0	104
3318		90	190	73,0	216,0	240,0	2000	3000	9,230	3,0	125
3219		95	170	55,6	140,0	163,0	2200	3200	5,000	2,1	111
3319		95	200	77,8	220,0	245,0	1900	2800	11,400	3,0	133
3220		100	180	60,3	160,0	196,0	2000	3000	6,100	2,1	118
3320		100	215	82,6	240,0	280,0	1800	2600	14,200	3,0	139
3222		110	200	69,8	190,0	228,0	1900	2800	8,790	2,1	132
3322		110	240	92,1	280,0	400,0	1800	2600	19,000	3,0	153



ROLLWAY

NUJP 222 EM C3

NUJP 222 EM C3

ROLLWAY

CYLINDRICAL ROLLER BEARINGS

Dimensions in accordance with ISO 15-2008

Cylindrical roller bearings are manufactured in a number of designs as indicated on the following page, the predominant type being the single row roller. The roller and cage assembly are guided axially by the integral flanges (ribs) on one of the bearing rings. This design facilitates ease of mounting and dismounting, particularly where both races are an interference fit on their seatings. Roller bearings with flanges (ribs) on one race only do not provide any end location. Various roller bearings with ribs on both races provide axial location, and are capable of carrying light or intermittent axial loading. These patterns are of the NJ, NUP and NJ+HJ types. If used for axial location and light axial loads, the contact between the flanges (ribs) and the roller ends is that of a sliding bearing, not rolling bearing; therefore lubrication is of paramount importance.

Alignment is much more critical than that of a ball bearing; as a general guide, this is limited to approximately .003 radians.

Double and multi-row bearings are also manufactured - see NN and NNU series.

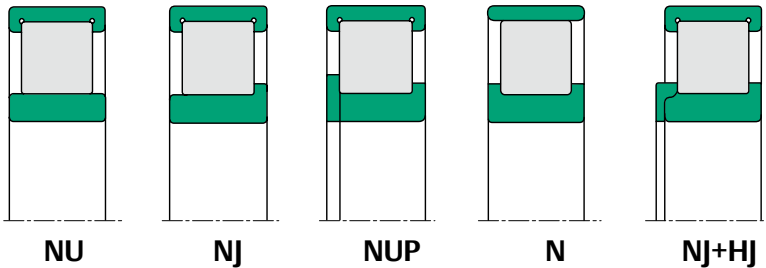

Of these bearings, the NJ, NUP and NJH types can also carry light or intermittent thrust loads between the guide rib and the end of the rollers. Several arrangements of locating ribs are available, as illustrated. The choice between these types is usually decided by consideration of assembly procedure or machine clearances. The bearings utilizing machined bronze cages are suitable for high speed operation. The NN 30 and NN 30 K series are available in high precision tolerances and, due to their extreme rigidity, are particularly suited for use in machine tool spindles.

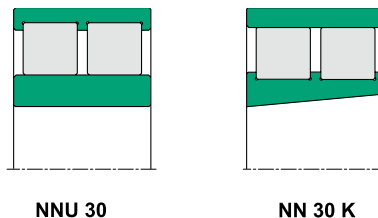

Single Row Cylindrical Roller Bearings

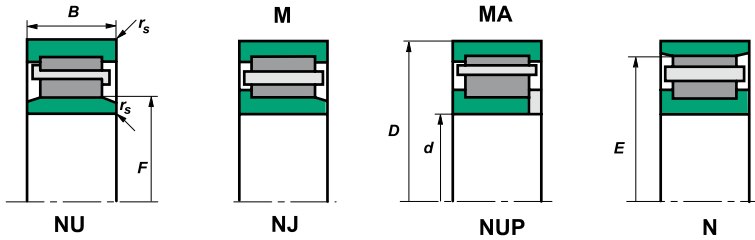

Bearing		ISO dimensions			Load ratings		Speed limits		Weight kg	Dimensions			
Type	Version	d mm	D	B	C kN	Co kN	Grease r/min	Oil r/min		F	E	r _s min	r _{1s} min
NU 202	E	15	35	11	13,5	11,2	18000	22000	0,052	19,3		0,6	0,3
NJ 202	EM6	15	35	11	13,5	11,2	18000	22000	0,055	19,3		0,6	0,3
NJ 203		17	40	12	11,2	9	17000	20000	0,091	22,1		0,6	0,3
NU 203	.	17	40	12	19,7	17	18000	20000	0,064	22,9		0,6	0,3
NU 203	M.	17	40	12	19,7	17	18000	20000	0,08	22,1		0,6	0,3
NU 203	EM.	17	40	12	17,6	14,6	18000	18000	0,01	22,1		0,6	0,3
NU 2203		17	40	16	17,5	15	16000	19000	0,067	22,9		0,6	0,3
NU 2203	E	17	40	16	22,4	19,8	16000	19000	0,097	22,1		0,6	0,3
NU303		17	47	14	16,4	13	13000	16000	0,12	25,1		1	0,6
NUP2203		17	40	16	17,5	15	16000	19000	0,089	22,9		0,6	0,3
NUP2203	E	17	40	16	22,4	19,8	16000	19000	0,089	22,1		0,6	0,3
N 204		20	47	14	15,2	12,5	15000	18000	0,11		40,0	1	0,6
NJ 204		20	47	14	15,2	12,5	15000	18000	0,11	27,0		1	0,6
NJ 204	E	20	47	14	25,7	22,6	15000	18000	0,11	26,5		1	0,6
NJ 204	EM	20	47	14	25,7	22,6	15000	18000	0,11	26,5		1	0,6
NJ 2204		20	47	18	20,7	18,5	13000	16000	0,142	26,5		1	0,6
NJ 2204	E	20	47	18	30,6	28,3	13000	16000	0,142	26,5		1	0,6
NJ 2204	EM	20	47	18	30,6	28,3	13000	16000	0,142	26,5		1	0,6
NJ 2304	EM	20	52	21	42	38,8	11000	14000	0,207	27,5		1,1	0,6
NJ 2304	E	20	52	21	42	38,8	11000	14000	0,207	27,5		1,1	0,6
NJ 304		20	52	15	21,1	17,1	12000	15000	0,152	27,5		1,1	0,6
NJ 304	EM	20	52	15	31,7	26,9	12000	15000	0,14	28,5		1,1	0,6
NU 204		20	47	14	15,2	12,5	15000	18000	0,11	27,0		1	0,6
NU 204	E	20	47	14	25,7	22,6	15000	18000	0,11	26,5		1	0,6
NU 204	EM.	20	47	14	17	14,4	17000	20000	0,124	27,0		1	0,6



Bearing		ISO dimensions			Load ratings		Speed limits		Weight kg	Dimensions			
Type	Version	d mm	D	B	C kN	Co kN	Grease r/min	Oil r/min		F	E	r _s min	r _{1s} min
NU 2204		20	47	18	20,7	18,5	13000	16000	0,14	27,0		1	0,6
NU 2204	E	20	47	18	30,6	28,3	13000	16000	0,14	27,0		1	0,6
NU 2204	EM	20	47	18	30,5	28,2	13000	16000	0,137	26,5		1	0,6
NU 2304	EM	20	52	21	42	38,8	11000	14000	0,22	27,5		1,1	0,6
NU 2304	E	20	52	21	42	38,8	11000	14000	0,207	27,5		1,1	0,6
NU 304		20	52	15	21,1	17,1	12000	15000	0,152	27,5		1,1	0,6
NU 304	EM	20	52	15	31,7	26,9	12000	15000	0,14	28,5		1,1	0,6
NUP 204	EM	20	47	14	25,7	22,6	15000	18000	0,11	26,5		1	0,6
NUP 204	E	20	47	14	25,7	22,6	15000	18000	0,11	26,5		1	0,6
NUP 2204	E	20	47	18	30,6	28,3	13000	16000	0,14	28,5		1	0,6
NUP 304		20	52	15	21,1	17,1	12000	15000	0,152	27,5		1,1	0,6
NUP 304	EM	20	52	15	31,7	26,9	12000	15000	0,22	27,5		1,1	0,6
NUP 2304	EM	20	52	21	42	38,8	11000	14000	0,084	30,5		1,1	0,6
N 205		25	52	15	17,7	15,7	12000	15000	0,16		31,5	1	0,6
N 305		25	62	17	29,3	25,2	10000	13000	0,24		53,0	1,1	1,1
N 305	EM	25	62	17	41,2	37	10000	13000	0,243		54,0	1,1	1,1
NJ 205		25	52	15	17,7	15,7	12000	15000	0,14	32,0		1	0,6
NJ 205	E	25	52	15	28,5	26,7	12000	15000	0,14	31,5		1	0,6
NJ 205	EM	25	52	15	28,5	26,7	12000	15000	0,14	31,5		1	0,6
NJ 205	E	25	52	15	28,5	26,7	12000	15000	0,14	31,5		1	0,6
NJ 2205	E	25	52	18	34,6	34,3	11000	14000	0,16	31,5		1	0,6
NJ 2205	EM	25	52	18	34,6	34,3	11000	14000	0,17	31,5		1	0,6
NJ 305		25	62	17	29,3	25,2	10000	13000	0,24	35,0		1,1	1,1
NJ 305	E	25	62	17	41,2	37	10000	13000	0,24	34,0		1,1	1,1
NJ 305	M.	25	62	17	37,3	35,9	9000	12000	0,28	35,0		1,1	1,1

Single Row Cylindrical Roller Bearings

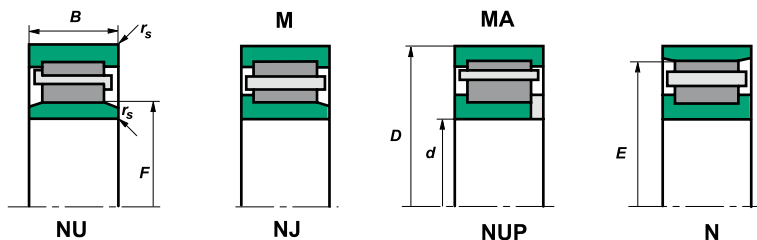

Bearing		ISO dimensions			Load ratings		Speed limits		Weight kg	Dimensions			
Type	Version	d mm	D	B	C kN	Co kN	Grease r/min	Oil r/min		F	E	r _s min	r _{1s} min
NJ 305	EM	25	62	17	41,2	37	10000	13000	0,243	34,0		1,1	1,1
NJ 2305	E	25	62	24	56,7	55,7	9500	12000	0,348	34,0		1,1	1,1
NJ 2305	EM	25	62	24	56,7	55,7	9500	12000	0,348	34,0		1,1	1,1
NU 1005		25	47	12	13,4	20,5	15000	18000	0,14	32,0		0,6	0,3
NU 205		25	52	15	17,7	15,7	12000	15000	0,14	31,5		1	0,6
NU 205	E	25	52	15	28,5	26,7	12000	15000	0,14	31,5		1	0,6
NU 205	EM	25	52	15	28,5	26,7	12000	15000	0,14	31,5		1	0,6
NU 205	E	25	52	15	28,5	26,7	12000	15000	0,14	31,5		1	0,6
NU 2205	E	25	52	18	34,6	34,3	11000	14000	0,17	31,5		1	0,6
NU 2205	EM	25	52	18	34,6	34,3	11000	14000	0,17	31,5		1	0,6
NU 305	E	25	62	17	29,3	25,2	10000	13000	0,243	34,0		1,1	1,1
NU 305	EM	25	62	17	29,3	25,2	10000	13000	0,243	34,0		1,1	1,1
NU 305	M	25	62	17	29,3	25,2	10000	13000	0,243	35,0		1,1	1,1
NU 2305	EM	25	62	24	56,7	55,7	8500	12000	0,348	34,0		1,1	1,1
NU 2305	E	25	62	24	56,7	55,7	9500	12000	0,34	34,0		1,1	1,1
NU 405		25	80	24	48	41,5	8500	11000	0,629	38,8		1,1	1,1
NU 405	M	25	80	24	50,6	44,4	8500	10000	0,61	38,8		1,5	1,5
NUP 205	E	25	52	15	28,5	26,7	12000	15000	0,14	31,5		1	0,6
NUP 2205	E	25	52	18	34,6	34,3	11000	14000	0,16	31,5		1	0,6
NUP 2205	EM	25	52	18	34,6	34,3	11000	14000	0,17	31,5		1	0,6
NUP 2305	E	25	62	24	56,7	55,7	9500	12000	0,352	34,0		1,1	1,1
NUP 305	M	25	62	17	31,7	31,2	10000	13000	0,3	34,0		1,1	1,1
NUP 305	EM	25	62	17	41,2	37	10000	13000	0,3	34,0		1,1	1,1
NUP 405	M	25	80	24	50,6	44,4	8500	10000	0,65	38,8		1,5	1,5
N 206		30	62	16	23,4	21,5	10000	13000	0,206		55,5	1	0,6



Bearing		ISO dimensions			Load ratings		Speed limits		Weight kg	Dimensions			
Type	Version	d mm	D	B	C kN	Co kN	Grease r/min	Oil r/min		F	E	r _s min	r _{1s} min
N 206	EM	30	62	16	39,7	37,9	10000	13000	0,26		55,5	1	0,6
N 306		30	72	19	38,7	35,2	8500	10000	0,35		62,0	1,1	1,1
N 2306		30	72	27	51,4	50,8	8500	10000	0,53		62,0	1,1	1,1
NJ 206		30	62	16	23,4	21,5	10000	13000	0,2	38,5		1	0,6
NJ 206	E	30	62	16	39,7	37,9	10000	13000	0,2	37,5		1	0,6
NJ 206	EM	30	62	16	39,7	37,9	10000	13000	0,2	37,5		1	0,6
NJ 206	E	30	62	16	39,7	37,9	10000	13000	0,2	37,5		1	0,6
NJ 2206		30	62	20	32,8	33,1	9000	11000	0,26	38,5		1	0,6
NJ 2206	EM	30	62	20	48,9	49,9	9000	11000	0,251	37,5		1	0,6
NJ 2206	E	30	62	20	48,9	49,9	9000	11000	0,255	37,5		1	0,6
NJ 306	E	30	72	19	50,5	47	8500	10000	0,35	40,5		1,1	1,1
NJ 306	EM	30	72	19	50,5	47	8500	10000	0,37	40,5		1,1	1,1
NJ 2306		30	72	27	51,4	50,8	8500	10000	0,53	42,0		1,1	1,1
NJ 2306	EM	30	72	27	71,9	74	8500	10000	0,52	40,5		1,1	1,1
NJ 2306	E	30	72	27	71,9	74	8500	10000	0,52	40,5		1,1	1,1
NJ 406	M	30	90	23	65	57,8	7500	9000	0,867	45,0		1,5	1,5
NJ 406	M	30	90	23	65	57,8	7500	9000	0,867	45,0		1,5	1,5
NU 206		30	62	16	23,4	21,5	10000	13000	0,2	38,5		1	0,6
NU 206	E	30	62	16	39,7	37,9	10000	13000	0,206	37,5		1	0,6
NU 206	EM	30	62	16	39,7	37,9	10000	13000	0,206	37,5		1	0,6
NU 2206		30	62	20	32,8	33,1	9000	11000	0,26	38,5		1	0,6
NU 2206	E	30	62	20	48,9	49,9	9000	11000	0,26	37,5		1	0,6
NU 2206	M.	30	62	20	48	53,9	7500	11000	0,3	37,5		1	0,6
NU 2206	EM	30	62	20	48,9	49,9	9000	11000	0,26	37,5		1	0,6
NU 2206	E	30	62	20	48,9	49,9	9000	11000	0,255	37,5		1	0,6

Single Row Cylindrical Roller Bearings

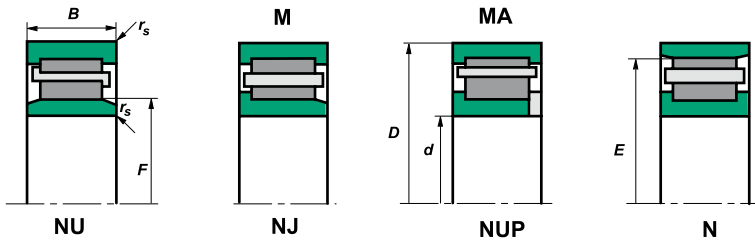

Bearing		ISO dimensions			Load ratings		Speed limits		Weight kg	Dimensions			
Type	Version	d mm	D	B	C kN	Co kN	Grease r/min	Oil r/min		F	E	r _s min	r _{1s} min
NU 306	E	30	72	19	50,5	47	8500	10000	0,37	40,5		1,1	1,1
NU 306	EM	30	72	19	50,5	47	8500	10000	0,37	40,5		1,1	1,1
NU 306	E	30	72	19	50,5	47	8500	10000	0,35	40,5		1,1	1,1
NU 306	M	30	72	19	38,7	35,2	8500	10000	0,37	42,0		1,1	1,1
NU 406		30	90	23	65	57,8	7500	9000	0,75	45,0		1,5	1,5
NU 406	M	30	90	23	65	57,8	7500	9000	0,867	45,0		1,5	1,5
NU 2306		30	72	27	51,4	50,8	8500	10000	0,53	42,0		1,1	1,1
NU 2306	E	30	72	27	71,9	74	8500	10000	0,5	40,5		1,1	1,1
NUP 206	E	30	62	16	39,7	37,9	10000	13000	0,2	37,5		1	0,6
NUP 206	EM	30	62	16	39,7	37,9	10000	13000	0,2	37,5		1	0,6
NUP 206	E	30	62	16	39,7	37,9	10000	13000	0,2	37,5		1	0,6
NUP 206	M	30	62	16	23,4	21,5	10000	13000	0,2	38,5		1	0,6
NUP 2206		30	62	20	32,8	33,1	9000	11000	0,255	38,5		1	0,6
NUP 2206	E	30	62	20	48,9	49,9	9000	11000	0,255	37,5		1	0,6
NUP 306		30	72	19	38,7	35,2	8500	10000	0,37	42,0		1,1	1,1
NUP 306	E	30	72	19	50,5	47	8500	10000	0,38	40,5		1,1	1,1
NUP 2306		30	72	27	51,4	50,8	8500	10000	0,53	42,0		1,1	1,1
NUP 2306	E	30	72	27	71,9	74	8500	10000	0,53	40,5		1,1	1,1
NUP 2306	EM	30	72	27	71,9	74	8500	10000	0,53	40,5		1,1	1,1
NUP 2306	E	30	72	27	71,9	74	8500	10000	0,53	40,5		1,1	1,1
NUP 2306	M	30	72	27	51,4	50,8	8500	10000	0,53	42,0		1,1	1,1
N 207		35	72	17	33,6	31,5	9000	11000	0,303		61,8	1,1	0,6
N 307		35	80	21	47,3	44,1	8500	10000	0,485		68,2	1,5	1,1
N 307	E	35	80	21	63,8	61,6	8500	10000	0,47		70,2	1,5	1,1
N 307	EM	35	80	21	63,8	61,6	8500	10000	0,47		70,2	1,5	1,1



Bearing		ISO dimensions			Load ratings		Speed limits		Weight kg	Dimensions			
Type	Version	d mm	D	B	C kN	Co kN	Grease r/min	Oil r/min		F	E	r _s min	r _{1s} min
NJ 207		35	72	17	33,6	31,5	9000	11000	0,303	43,8		1,1	0,6
NJ 207	E	35	72	17	49,9	49,7	9000	11000	0,303	44,0		1,1	0,6
NJ 207	EM	35	72	17	49,9	49,7	9000	11000	0,303	44,0		1,1	0,6
NJ 207	M	35	72	17	33,6	31,5	9000	11000	0,303	43,8		1,1	0,6
NJ 2207		35	72	23	49	51,3	8000	9500	0,395	43,8		1,1	0,6
NJ 2207	E	35	72	23	64,9	69,8	8000	9500	0,395	44,0		1,1	0,6
NJ 2207	EM	35	72	23	64,9	69,8	8000	9500	0,395	44,0		1,1	0,6
NJ 2207	M	35	72	23	49	51,3	8000	9500	0,395	43,8		1,1	0,6
NJ 307	E	35	80	21	63,8	61,6	8500	10000	0,49	46,2		1,5	1,1
NJ 307	EM	35	80	21	63,8	61,6	8500	10000	0,485	46,2		1,5	1,1
NJ 307	EM.	35	80	21	62	63,3	7000	9000	0,55	46,2		1,5	1,1
NJ 307	M	35	80	21	47,3	44,1	8500	10000	0,485	46,2		1,5	1,1
NJ 307	M.	35	80	21	60,1	63,3	7000	9000	0,48	46,2		1,5	1,1
NJ 2307		35	80	31	58,3	57,6	7500	9000	0,72	46,2		1,5	1,1
NJ 2307	E	35	80	31	85,5	89,9	7500	9000	0,727	46,2		1,5	1,1
NJ 2307	M	35	80	31	58,3	57,6	7500	9000	0,72	46,2		1,5	1,1
NJ 407	M	35	100	25	75,7	69,4	6700	8000	1,03	53,0		1,5	1,5
NU 1007		35	62	14	21,6	21,8	10000	13000	0,18	42,0		1	0,5
NU 207		35	72	17	33,6	31,5	9000	11000	0,303	43,8		1,1	0,6
NU 207	E	35	72	17	49,9	49,7	9000	11000	0,303	44,0		1,1	0,6
NU 207	EM	35	72	17	49,9	49,7	9000	11000	0,303	44,0		1,1	0,6
NU 2207		35	72	23	49	51,3	8000	9500	0,395	43,8		1,1	0,6
NU 2207	E	35	72	23	64,9	69,8	8000	9500	0,395	44,0		1,1	0,6
NU 2207	EM	35	72	23	64,9	69,8	8000	9500	0,395	44,0		1,1	0,6

Single Row Cylindrical Roller Bearings

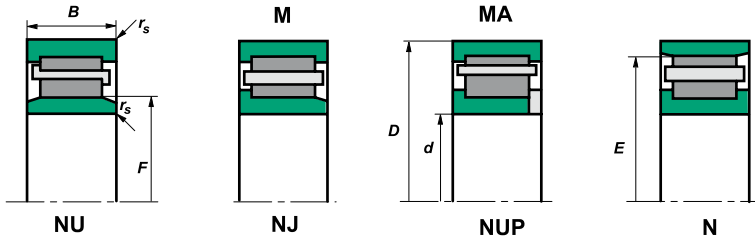

Bearing		ISO dimensions			Load ratings		Speed limits		Weight kg	Dimensions			
Type	Version	d mm	D	B	C kN	Co kN	Grease r/min	Oil r/min		F	E	r _s min	r _{1s} min
NU 307	E	35	80	21	63,8	61,6	8500	10000	0,485	46,2		1,5	1,1
NU 307	EM	35	80	21	63,8	61,6	8500	10000	0,485	46,2		1,5	1,1
NU 307	M	35	80	21	47,3	44,1	8500	10000	0,485	46,2		1,5	1,1
NU 2307		35	80	31	58,3	57,6	7500	9000	0,72	46,2		1,5	1,1
NU 2307	E	35	80	31	85,5	89,9	7500	9000	0,696	46,2		1,5	1,1
NU 2307	M	35	80	31	58,3	57,6	7500	9000	0,72	46,2		1,5	1,1
NU 407		35	100	25	75,7	69,4	6700	8000	1,02	53,0		1,5	1,5
NU 407	M	35	100	25	75,7	69,4	6700	8000	1,03	53,0		1,5	1,5
NUP 207		35	72	17	33,6	31,5	9000	11000	0,303	43,8		1,1	0,6
NUP 207	E	35	72	17	49,9	49,7	9000	11000	0,303	44,0		1,1	0,6
NUP 2207		35	72	23	49	51,3	8000	9500	0,95	43,8		1,1	0,6
NUP 2207	E	35	72	23	65,3	70,3	8000	9500	0,43	44,0		1,1	0,6
NUP 307	E	35	80	21	63,8	61,6	8500	10000	0,485	46,2		1,5	1,1
NUP 307	EM	35	80	21	63,8	61,6	8500	10000	0,485	46,2		1,5	1,1
NUP 2307		35	80	31	58,3	57,6	7500	9000	0,72	46,2		1,5	1,1
NUP 2307	E	35	80	31	85,5	89,9	7500	9000	0,696	46,2		1,5	1,1
N 208		40	80	18	43,7	42,9	8000	9500	0,38		70,0	1,1	1,1
N 208	EM	40	80	18	51,5	53	7000	9000	0,44		70,0	1,1	1,1
N 308		40	90	23	56,2	53,8	7000	8500	0,66		77,5	1,5	1,5
N 408	M	40	110	27	93,8	86,8	6000	7000	1,31		92,0	2	2
NJ 208		40	80	18	43,7	42,9	8000	9500	0,38	50,0		1,1	1,1
NJ 208	E	40	80	18	52,6	51,6	8000	9500	0,38	49,5		1,1	1,1
NJ 208	EM	40	80	18	52,6	51,6	8000	9500	0,38	49,5		1,1	1,1
NJ 208	M	40	80	18	43,7	42,9	8000	9500	0,38	50,0		1,1	1,1



Bearing		ISO dimensions			Load ratings		Speed limits		Weight kg	Dimensions			
Type	Version	d mm	D	B	C kN	Co kN	Grease r/min	Oil r/min		F	E	r _s min	r _{1s} min
NJ 2208		40	80	23	58,1	62	7500	9000	0,49	50,0		1,1	1,1
NJ 2208	E	40	80	23	70,3	74,8	7500	9000	0,5	49,5		1,1	1,1
NJ 2208	EM	40	80	23	70,3	74,8	7500	9000	0,5	49,5		1,1	1,1
NJ 308		40	90	23	56,2	53,8	7000	8500	0,66	53,5		1,5	1,5
NJ 308	E	40	90	23	79,9	77,5	7000	8500	0,68	52,0		1,5	1,5
NJ 308	EM	40	90	23	79,9	77,5	7000	8500	0,68	52,0		1,5	1,5
NJ 308	M	40	90	23	56,2	53,8	7000	8500	0,66	53,5		1,5	1,5
NJ 2308		40	90	33	80	84,9	6700	8000	0,95	53,5		1,5	1,5
NJ 2308	E	40	90	33	111	118	6700	8000	0,95	52,0		1,5	1,5
NJ 2308	EM	40	90	33	111	118	6700	8000	0,95	52,0		1,5	1,5
NJ 408		40	110	27	93,8	86,8	6000	7000	1,3	58,0		2	2
NJ 408	M	40	110	27	93,8	86,8	6000	7000	1,31	58,0		2	2
NU 1008	M	40	68	15	24	25,7	9500	12000	0,223	47,0		1	0,6
NU 208		40	80	18	43,7	42,9	8000	9500	0,38	50,0		1,1	1,1
NU 208	E	40	80	18	52,6	51,6	8000	9500	0,38	49,5		1,1	1,1
NU 208	EM	40	80	18	52,6	51,6	8000	9500	0,38	49,5		1,1	1,1
NU 208	E	40	80	18	52,6	51,6	8000	9500	0,366	49,5		1,1	1,1
NU 208	M	40	80	18	43,7	42,9	8000	9500	0,38	50,0		1,1	1,1
NU 2208		40	80	23	58,1	62	7500	9000	0,49	50,0		1,1	1,1
NU 2208	EMA	40	80	23	70,3	74,8	7500	9000	0,56	49,5		1,1	1,1
NU 308		40	90	23	56,2	53,8	7000	8500	0,66	53,5		1,5	1,5
NU 308	E	40	90	23	79,9	77,5	7000	8500	0,65	52,0		1,5	1,5
NU 308	EM	40	90	23	79,9	77,5	7000	8500	0,65	52,0		1,5	1,5
NU 308	M	40	90	23	56,2	53,8	7000	8500	0,66	53,5		1,5	1,5

Single Row Cylindrical Roller Bearings

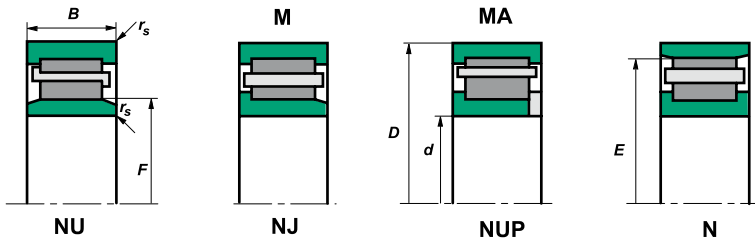

Bearing		ISO dimensions			Load ratings		Speed limits		Weight kg	Dimensions			
Type	Version	d mm	D	B	C kN	Co kN	Grease r/min	Oil r/min		F	E	r _s mm	r _{1s} mm
NU 2308	E	40	90	33	111	118	6700	8000	0,95	52,0		1,5	1,5
NU 2308	EM	40	90	33	111	118	6700	8000	0,95	52,0		1,5	1,5
NU 2308	M	40	90	33	80	84,9	6700	8000	0,95	53,5		1,5	1,5
NU 408		40	110	27	93,8	66,8	6000	7000	1,3	58,0		2	2
NU 408	M	40	110	27	93,8	86,8	6000	7000	1,31	58,0		2	2
NUP 208		40	80	18	43,7	42,9	8000	9500	0,38	50,0		1,1	1,1
NUP 208	EM	40	80	18	52,6	51,6	8000	9500	0,391	49,5		1,1	1,1
NUP 208	E	40	80	18	52,6	51,6	8000	9500	0,38	49,5		1,1	1,1
NUP 208	EM	40	80	18	52,6	51,6	8000	9500	0,38	49,5		1,1	1,1
NUP 2208		40	80	23	58,1	62	7500	9000	0,49	50,0		1,1	1,1
NUP 2208	E	40	80	23	70,3	74,8	7500	9000	0,49	49,5		1,1	1,1
NUP 2208	EM	40	80	23	70,3	74,8	7500	9000	0,49	49,5		1,1	1,1
NUP 308	E	40	90	23	81,5	87,3	7000	8500	0,83	52,0		1,5	1,5
NUP 308	EM	40	90	23	81,5	87,3	7000	8500	0,83	52,0		1,5	1,5
NUP 2308		40	90	33	80	84,9	6700	8000	0,95	53,5		1,5	1,5
NUP 2308	E	40	90	33	111	118	6700	8000	0,95	52,0		1,5	1,5
NUP 2308	EM	40	90	33	111	118	6700	8000	0,95	52,0		1,5	1,5
NUP 408		40	110	27	93,8	86,8	6000	7000	1,3	58,0		2	2
NUP 408	M	40	110	27	93,8	86,8	6000	7000	1,31	58,0		2	2
N 209	M	45	85	19	46	46,9	7500	9000	0,445		75,0	1,1	1,1
N 309		45	100	25	71,2	67,8	6000	7000	0,895		86,5	1,5	1,5
N 409	M	45	120	29	104	97,8	5600	6700	1,66		100,5	2	2
NJ 209		45	85	19	46	46,9	7500	9000	0,445	55,0		1,1	1,1
NJ 209	EM	45	85	19	63	66,4	8000	6300	0,519				



Bearing		ISO dimensions			Load ratings		Speed limits		Weight kg	Dimensions			
Type	Version	d mm	D	B	C kN	Co kN	Grease r/min	Oil r/min		F	E	r _s min	r _{1s} min
NJ 209	E	45	85	19	60,2	62,8	7500	9000	0,445	54,5		1,1	1,1
NJ 2209		45	85	23	61,2	67,8	7500	9000	0,53	55,0		1,1	1,1
NJ 2209	E	45	85	23	76,1	84,6	5500	8000	0,55	54,5		1,1	1,1
NJ 2209	EM	45	85	23	76,1	84,6	5500	8000	0,55	54,5		1,1	1,1
NJ 2209	M	45	85	23	61,2	67,8	7500	9000	0,53	55,0		1,1	1,1
NJ 309	E	45	100	25	96,9	97,7	6000	7000	0,895	58,5		1,5	1,5
NJ 309	EM	45	100	25	96,9	97,7	6000	7000	0,895	58,5		1,5	1,5
NJ 309	M	45	100	25	71,2	67,8	6000	7000	0,895	58,5		1,5	1,5
NJ 2309		45	100	36	103	110	6000	7000	1,29	58,5		1,5	1,5
NJ 2309	EM	45	100	36	129,4	141,2	6000	7000	1,29	58,5		1,5	1,5
NJ 2309	M	45	100	36	103	110	6000	7000	1,29	58,5		1,5	1,5
NJ 409		45	120	29	121,2	111,5	5600	6700	1,7	64,5		1,5	1,5
NJ 409	M	45	120	29	121,2	111,5	5600	6700	1,87	64,5		1,5	1,5
NU 1009	M	45	75	16	31,4	34,8	9000	11000	0,289	52,5		1	0,6
NU 209		45	85	19	46	46,9	7500	9000	0,445	55,0		1,1	1,1
NU 209	E	45	85	19	60,2	62,8	7500	9000	0,427	54,5		1,1	1,1
NU 2209		45	85	23	61,2	67,8	7500	9000	0,53	55,0		1,1	1,1
NU 2209	E	45	85	23	76,1	84,6	5500	8000	0,55	54,5		1,1	1,1
NU 2209	EM	45	85	23	76,1	84,6	5500	8000	0,55	54,5		1,1	1,1
NU 2209	M	45	85	23	61,2	67,8	7500	9000	0,53	55,0		1,1	1,1
NU 309	E	45	100	25	96,9	97,7	6000	7000	0,87	58,5		1,5	1,5
NU 309	EM	45	100	25	96,9	97,7	6000	7000	0,895	58,5		1,5	1,5
NU 309	M	45	100	25	71,2	67,8	6000	7000	0,895	58,5		1,5	1,5
NU 2309		45	100	36	103	110	6000	7000	1,29	58,5		1,5	1,5

Single Row Cylindrical Roller Bearings

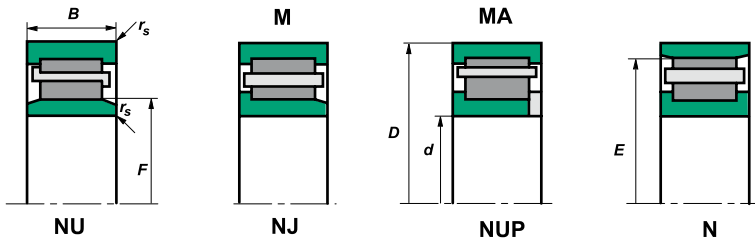

Bearing		ISO dimensions			Load ratings		Speed limits		Weight kg	Dimensions			
Type	Version	d mm	D	B	C kN	Co kN	Grease r/min	Oil r/min		F	E	r _s min	r _{1s} min
NU 2309	M	45	100	36	103	110	6000	7000	1,29	58,5		1,5	1,5
NU 2309	EM	45	100	36	129,4	141,2	6000	7000	1,29	58,5		1,5	1,5
NU 409		45	120	29	104	97,8	5600	6700	1,66	64,5		2	2
NU 409	M	45	120	29	104	97,8	5600	6700	1,66	64,5		2	2
NUP 209		45	85	19	46	46,9	7500	9000	0,445	55,0		1,1	1,1
NUP 209	E	45	85	19	60,2	62,8	7500	9000	0,445	54,5		1,1	1,1
NUP 209	EM	45	85	19	63	66,4	8000	6300	0,519	54,5		1,1	1,1
NUP 2209		45	85	23	61,2	67,8	7500	9000	0,53	55,0		1,1	1,1
NUP 2209	E	45	85	23	73,9	81,6	7500	9000	0,53	54,5		1,1	1,1
NUP 309	E	45	100	25	96,9	97,7	6000	7000	0,895	58,5		1,5	1,5
NUP 309	EM	45	100	25	96,9	97,7	6000	7000	0,895	58,5		1,5	1,5
NUP 2309	E	45	100	36	130	142	6000	7000	1,25	58,5		1,5	1,5
NUP 2309	EM	45	100	36	129,4	141,2	6000	7000	1,29	58,5		1,5	1,5
NUP 2309	M	45	100	36	103	110	6000	7000	1,29	58,5		1,5	1,5
NUP 409		45	120	29	104	97,8	5600	6700	1,64	64,5		2	2
NUP 409	M	45	120	29	104	97,8	5600	6700	1,66	64,5		2	2
N 210		50	90	20	48,2	51	6700	8000	0,49		60,4	1,1	1,1
N 310		50	110	27	86,9	86,2	8500	6500	1,14		95,0	2	2
N 410	M	50	130	31	139	136	4800	5600	2,01		110,8	2,1	2,1
NJ 1010	M	50	80	16	32,1	36,1	8500	10000	0,32	57,5		1	0,6
NJ 210	EM	50	90	20	61,2	69,2	6000	7500	0,59				
NJ 210		50	90	20	48,2	51	6700	8000	0,49	60,4		1,1	1,1
NJ 210	E	50	90	20	63,7	68,3	6700	8000	0,499	59,5		1,1	1,1
NJ 210	M	50	90	20	48,2	51	6700	8000	0,49	60,4		1,1	1,1



Bearing		ISO dimensions			Load ratings		Speed limits		Weight kg	Dimensions			
Type	Version	d mm	D	B	C kN	Co kN	Grease r/min	Oil r/min		F	E	r _s min	r _{1s} min
NJ 2210		50	90	23	61,8	70,2	6900	8300	0,575	60,4		1,1	1,1
NJ 2210	E	50	90	23	76,8	87,6	6900	8300	0,6	59,5		1,1	1,1
NJ 2210	EM	50	90	23	76,8	87,6	6900	8300	0,6	59,5		1,1	1,1
NJ 2210	M	50	90	23	61,8	70,2	6900	8300	0,575	60,4		1,1	1,1
NJ 310	E	50	110	27	110	112	6000	7000	1,14	65		2	2
NJ 310	EM	50	110	27	119	125	5300	6700	1,34	65		2	2
NJ 310	M	50	110	27	86,9	86,2	6000	7000	1,14	65		2	2
NJ 2310	E	50	110	40	163	187	5300	6200	1,74	65		2	2
NJ 2310	EM	50	110	40	163	187	5300	6200	1,74	65,0		2	2
NJ 410	M	50	130	31	139	136	4800	5600	2,08	70,8		2,1	2,1
NU 1010	M	50	80	16	32,1	36,1	8500	10000	0,31	57,5		1	0,6
NU 210		50	90	20	48,2	51	6700	8000	0,49	60,4		1,1	1,1
NU 210	EM	50	90	20	63,7	68,3	6700	8000	0,48	59,5		1,1	1,1
NU 210	E	50	90	20	63,7	68,3	6700	8000	0,49	59,5		1,1	1,1
NU 2210		50	90	23	61,8	70,2	6900	8300	0,575	60,4		1,1	1,1
NU 2210	EM	50	90	23	76,8	87,6	6900	8300	0,58	59,5		1,1	1,1
NU 2210	E	50	90	23	76,8	87,6	6900	8300	0,58	59,5		1,1	1,1
NU 2210	M	50	90	23	61,8	70,2	6900	8300	0,575	60,4		1,1	1,1
NU 310	E	50	110	27	110	112	6000	7000	1,14	65,0		2	2
NU 310	EM	50	110	27	110	112	6000	7000	1,14	65,0		2	2
NU 2310	E	50	110	40	162	187	5300	6200	1,74	65,0		2	2
NU 2310	EM	50	110	40	162	187	5300	6200	1,74	65,0		2	2
NU 410	M	50	130	31	139	136	4800	5600	2,01	70,8		2,1	2,1
NUP 210		50	90	20	48,2	51	6700	8000	0,49	60,4		1,1	1,1

Single Row Cylindrical Roller Bearings

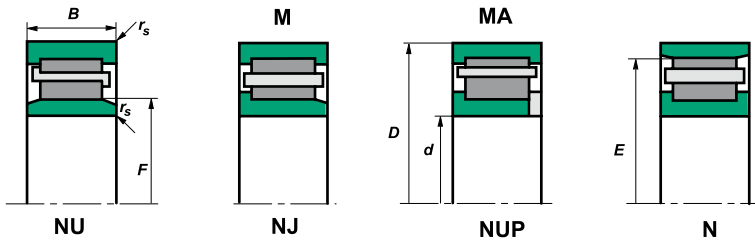

Bearing		ISO dimensions			Load ratings		Speed limits		Weight kg	Dimensions			
Type	Version	d mm	D	B	C kN	Co kN	Grease r/min	Oil r/min		F	E	r _s min	r _{1s} min
NUP 210	E	50	90	20	63,7	68,3	6700	8000	0,52	59,5		1,1	1,1
NUP 2210		50	90	23	61,8	70,2	6900	8300	0,575	60,4		1,1	1,1
NUP 2210	E	50	90	23	76,8	87,6	6900	8300	0,6	59,5		1,1	1,1
NUP 2210	EM	50	90	23	76,8	87,6	6900	8300	0,6	59,5		1,1	1,1
NUP 310	EM	50	110	27	110	112	6000	7000	1,14	65,0		2	2
NUP 310	E	50	110	27	110	112	6000	7000	1,21	65,0		2	2
NUP 2310	E	50	110	40	163	186	5300	6200	1,74	65,0		2	2
N 211		55	100	21	57,9	62,5	6300	7500	0,665		88,5	1,5	1,1
N 211	M	55	100	21	57,9	62,5	6300	7500	0,665		88,5	1,5	1,1
N 311		55	120	29	109	109	5000	6000	1,47		104,5	2	2
N 411		55	140	33	139	138	4300	5000	2,54		117,2	2,1	2,1
NJ 211		55	100	21	57,9	62,5	6300	7500	0,665	66,5		1,5	1,1
NJ 211	E	55	100	21	82,6	93,4	6300	7500	0,66	66,0		1,5	1,1
NJ 211	EM	55	100	21	82,6	93,4	6300	7500	0,66	66,0		1,5	1,1
NJ 2211	E	55	110	25	98,9	118	6300	7500	0,78	66,0		1,1	2
NJ 2211	EM	55	110	25	98,9	118	6300	7500	0,78	66,0		1,1	2
NJ 2211	M	55	100	25	76,3	89	6300	7500	0,78	66,5		1,5	1,1
NJ 311	E	55	120	29	134	138	5000	6000	1,44	70,5		2	2
NJ 311	EM	55	120	29	134	138	5000	6000	1,47	70,5		2	2
NJ 311	M	55	120	29	109	109	5000	6000	1,47	70,5		2	2
NJ 2311		55	120	43	146	159	4800	5700	2,5	70,5		2	2
NJ 2311	EM	55	120	43	148	162	4800	6000	2,86	70,5		2	2
NJ 2311	M	55	120	43	146	159	4800	5700	2,23	70,5		2	2
NJ 411		55	140	33	139	138	4300	5000	2,51	77,2		2,1	2,1



Bearing		ISO dimensions			Load ratings		Speed limits		Weight kg	Dimensions			
Type	Version	d mm	D	B	C kN	Co kN	Grease r/min	Oil r/min		F	E	r _s min	r _{1s} min
NJ 411	M	55	140	33	139	138	4300	5000	2,54	77,2		2,1	2,1
NU 1011	M	55	90	18	37,7	43,4	7800	9200	0,464	64,5		1,1	1
NU 211		55	100	21	57,9	62,5	6300	7500	0,665	66,5		1,5	1,1
NU 211	E	55	100	21	82,6	93,4	6300	7500	0,665	66,0		1,5	1,1
NU 211	EM	55	100	21	82,6	93,4	6300	7500	0,665	66,0		1,5	1,1
NU 211	EM	55	100	21	82,6	93,4	6300	7500	0,665	66,0		1,5	1,1
NU 2211	E	55	100	25	98,9	118	6300	7500	0,78	66,0		1,5	1,1
NU 2211	M	55	100	25	76,3	89	6300	7500	0,78	66,5		1,5	1,1
NU 2311		55	120	43	146	159	4800	5700	2,23	70,5		2	2
NU 2311	EM	55	120	43	187,3	213	4800	5600	2,5	70,5		2	2
NU 2311	M	55	120	43	146	159	4800	5700	2,5	70,5		2	2
NU 311	EM	55	120	29	134	138	5000	6000	1,47	70,5		2	2
NU 311	EMA	55	120	29	134	138	5000	6000	1,47	70,5		2	2
NU 411		55	140	33	139	138	4300	5000	2,51	77,2		2,1	2,1
NU 411	M	55	140	33	139	138	4300	5000	2,54	77,2		2,1	2,1
NUP 211	E	55	100	21	82,6	93,4	6300	7500	0,665	66,0		1,5	1,1
NUP 211	EM	55	100	21	82,6	93,4	6300	7500	0,665	66,0		1,5	1,1
NUP 2211	EM	55	100	25	101	121,5	6300	7500	0,85	66,0		1,5	1,5
NUP 2211	E	55	100	25	101	121,5	6300	7500	0,85	66,0		1,5	1,5
NUP 311		55	120	29	109	109	5000	6000	1,44	70,5		2	2
NUP 311	E	55	120	29	134	138	5000	6000	1,47	70,5		2	2
NUP 311	EM	55	120	29	134	138	5000	6000	1,47	70,5		2	2
NUP 2311		55	120	43	146	159	4800	5700	2,54	70,5		2	2
NUP 2311	EM	55	120	43	187,3	213	4800	5600	2,5	70,5		2	2

Single Row Cylindrical Roller Bearings

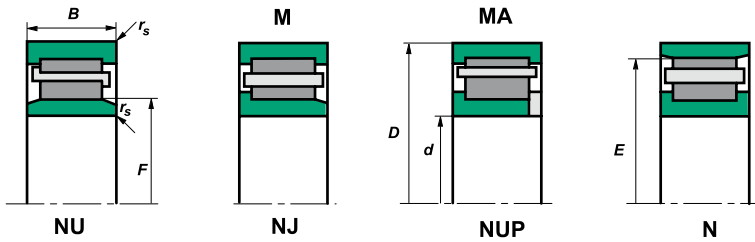

Bearing		ISO dimensions			Load ratings		Speed limits		Weight kg	Dimensions			
Type	Version	d mm	D	B	C kN	Co kN	Grease r/min	Oil r/min		F	E	r _s min	r _{1s} min
NUP 411		55	140	33	139	138	4300	5000	2,51	77,2		2,1	2,1
N 212		60	110	22	68,8	75,5	5600	6700	0,825		97,5	1,5	1,5
N 212	EM	60	110	22	93,4	101	5600	6700	0,825		100,0	1,5	1,5
N 312		60	130	31	121	123	4500	5300	1,85		113,0	2,1	2,1
N 312	M	60	130	31	121	123	4500	5300	1,85		113,0	2,1	2,1
N 2312		60	130	46	166	185	4300	5000	2,78		223,0	2,1	2,1
NJ 212		60	110	22	68,8	75,5	5600	6700	0,825	73,5		1,5	1,5
NJ 212	E	60	110	22	93,4	101	5600	6700	0,825	72,0		1,5	1,5
NJ 212	EM	60	110	22	93,4	101	5600	6700	0,825	72,0		1,5	1,5
NJ 2212		60	110	28	103	127	5000	6000	1,08	73,5		1,5	1,5
NJ 2212	E	60	110	28	128	153	5000	6000	1,08	72,0		1,5	1,5
NJ 312		60	130	31	121	123	4500	5300	1,88	77,0		2,1	2,1
NJ 312	E	60	130	31	148	155	4500	5300	1,88	77,0		2,1	2,1
NJ 312	EM	60	130	31	148	155	4500	5300	1,88	77,0		2,1	2,1
NJ 312	E	60	130	31	148	155	4500	5300	1,88	77,0		2,1	2,1
NJ 312	M	60	130	31	121	123	4500	5300	1,85	77,0		2,1	2,1
NJ 2312		60	130	46	166	185	4300	5000	2,78	77,0		2,1	2,1
NJ 2312	E	60	130	46	222	262	4300	5000	2,77	77,0		2,1	2,1
NJ 2312	EM	60	130	46	222	262	4300	5000	2,77	77,0		2,1	2,1
NJ 2312	EMA	60	130	46	222	262	4300	5000	2,77	77,0		2,1	2,1
NJ 412		60	150	35	178	184	4000	4800	3,07	83,0		2,1	2,1
NJ 412	M	60	150	35	178	184	4000	4800	3,07	83,0		2,1	2,1
NU 1012	EM	60	95	18	35,8	43,2	6700	8000	0,47	68,5		1,1	1
NU 1012	M	60	95	18	35,8	43,2	6700	8000	0,48	69,5		1,1	1



Bearing		ISO dimensions			Load ratings		Speed limits		Weight kg	Dimensions			
Type	Version	d mm	D	B	C kN	Co kN	Grease r/min	Oil r/min		F	E	r _s min	r _{1s} min
NU 212		60	110	22	68,8	75,5	5600	6700	0,825	73,5		1,5	1,5
NU 212	E	60	110	22	93,4	101	5600	6700	0,825	72,0		1,5	1,5
NU 212	EM	60	110	22	93,4	101	5600	6700	0,825	72,0		1,5	1,5
NU 2212		60	110	28	103	127	5000	6000	1,08	73,5		1,5	1,5
NU 2212	E	60	110	28	128	153	5000	6000	1,08	72,0		1,5	1,5
NU 2212	EM	60	110	28	128	153	5000	6000	1,08	72,0		1,5	1,5
NU 312		60	130	31	121	123	4500	5300	1,85	77,0		2,1	2,1
NU 312	E	60	130	31	148	155	4500	5300	1,83	77,0		2,1	2,1
NU 312	EM	60	130	31	148	155	4500	5300	1,83	77,0		2,1	2,1
NU 312	E	60	130	31	148	155	4500	5300	1,83	77,0		2,1	2,1
NU 312	M	60	130	31	121	123	4500	5300	1,85	77,0		2,1	2,1
NU 2312		60	130	46	166	185	4300	5000	1,85	77,0		2,1	2,1
NU 2312	E	60	130	46	222	262	4300	5000	2,78	77,0		2,1	2,1
NU 2312	EM	60	130	46	222	262	4300	5000	2,69	77,0		2,1	2,1
NU 2312	M	60	130	46	166	185	4300	5000	2,78	77,0		2,1	2,1
NU 412		60	150	35	178	184	4000	4800	2,78	83,0		2,1	2,1
NU 412	M	60	150	35	178	184	4000	4800	2,78	83,0		2,1	2,1
NUP 212	E	60	110	22	93,4	101	5600	6700	0,87	72,0		1,5	1,5
NUP 2212		60	110	28	103	127	5000	6000	1,08	73,5		1,5	2,1
NUP 2212	EM	60	110	28	136	165	5000	6000	1,08	72,0		1,5	2,1
NUP 2212	E	60	110	28	136	165	5000	6000	1,08	72,0		1,5	2,1
NUP 312	EM	60	130	31	148	155	4500	5300	1,85	77,0		2,1	2,1
NUP 312	E	60	130	31	148	155	4500	5300	1,93	77,0		2,1	2,1
NUP 312	M	60	130	31	121	123	4500	5300	1,85	77,0		2,1	2,1

Single Row Cylindrical Roller Bearings

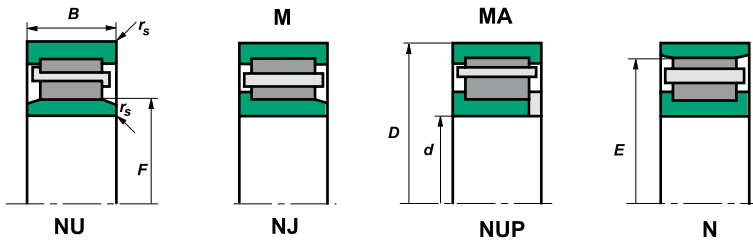

Bearing		ISO dimensions			Load ratings		Speed limits		Weight kg	Dimensions			
Type	Version	d mm	D	B	C kN	Co kN	Grease r/min	Oil r/min		F	E	r _s min	r _{1s} min
NUP 2312		60	130	46	166	185	4300	5000	2,77	77,0		2,1	2,1
NUP 2312	E	60	130	46	222	262	4300	5000	2,78	77,0		2,1	2,1
NUP 2312	EM	60	130	46	222	262	4300	5000	2,78	77,0		2,1	2,1
NUP 2312	EMA	60	130	46	222	262	4300	5000	2,78	77,0		2,1	2,1
NUP 412		60	150	35	178	184	4000	4800	3,02	83,0		2,1	2,1
NUP 412	M	60	150	35	178	184	4000	4800	3,07	83,0		2,1	2,1
N 213		65	120	23	80,5	89,7	5300	6300	1,05		105,6	1,5	1,5
N 313		65	140	33	143	151	4300	5000	2,24		121,5	2,1	2,1
N 313	EM	65	140	33	179	190	4300	5000	2,24		124,5	2,1	2,1
N 313	M	65	140	33	143	151	4300	5000	2,24		121,5	2,1	2,1
NJ 213		65	120	23	80,5	89,7	5300	6300	1,05	79,6		1,5	1,5
NJ 213	E	65	120	23	107	118	5300	6300	1,07	78,5		1,5	1,5
NJ 213	EM	65	120	23	107	118	5300	6300	1,07	78,5		1,5	1,5
NJ 2213		65	120	31	117	146	4800	5600	1,45	79,6		1,5	1,5
NJ 2213	EM	65	120	31	145	178	4800	5600	1,65	78,5		1,5	1,5
NJ 313		65	140	33	143	151	4300	5000	2,24	83,5		2,1	2,1
NJ 313	E	65	140	33	179	190	4300	5000	2,3	82,5		2,1	2,1
NJ 313	EM	65	140	33	179	190	4300	5000	2,24	82,5		2,1	2,1
NJ 313	EM.	65	140	33	165	189	4000	5000	3,3	82,5		2,1	2,1
NJ 313	M	65	140	33	143	151	4300	5000	2,24	83,5		2,1	2,1
NJ 2313	EM	65	140	48	245	285	4000	4800	3,35	82,5		2,1	2,1
NJ 413	M	65	160	37	195	203	3700	4500	3,68	89,3		2,1	2,1
NU 1013	M	65	100	18	39,2	49	6600	7800	3,07	74,5		1,1	1
NU 213		65	120	23	80,5	89,7	5300	6300	3,07	79,6		1,5	1,5



Bearing		ISO dimensions			Load ratings		Speed limits		Weight kg	Dimensions			
Type	Version	d mm	D	B	C kN	Co kN	Grease r/min	Oil r/min		F	E	r _s min	r _{1s} min
NU 213	E	65	120	23	107	118	5300	6300	1,05	78,5		1,5	1,5
NU 213	EM	65	120	23	107	118	5300	6300	1,05	78,5		1,5	1,5
NU 213	E	65	120	23	107	118	5300	6300	0,523	78,5		1,5	1,5
NU 213	M	65	120	23	80,5	89,7	5300	6300	1,05	79,6		1,5	1,5
NU 2213		65	120	31	117	146	4800	5600	1,45	79,6		1,5	1,5
NU 2213	EM	65	120	31	145	178	4800	5600	1,65	78,5		1,5	1,5
NU 313	E	65	140	33	179	190	4300	5000	1,65	78,5		2,1	2,1
NU 313	EM	65	140	33	179	190	4300	5000	2,24	82,5		2,1	2,1
NU 313	M	65	140	33	143	151	4300	5000	2,24	83,5		2,1	2,1
NU 2313	E	65	140	48	245	285	4000	4800	3,31	82,5		2,1	2,1
NU 2313	EM	65	140	48	245	285	4000	4800	3,31	82,5		2,1	2,1
NU 413		65	160	37	195	203	3700	4500	3,68	89,3		2,1	2,1
NU 413	M	65	160	37	195	203	3700	4500	3,68	89,3		2,1	2,1
NUP 213	EM	65	120	23	107	118	5300	6300	1,1	78,5		1,5	1,5
NUP 213	E	65	120	23	107	118	5300	6300	1,05	78,5		1,5	1,5
NUP 213	M	65	120	23	80,5	89,7	5300	6300	1,05	79,6		1,5	1,5
NUP 2213		65	120	31	117	146	4800	5600	1,42	79,6		1,5	1,5
NUP 2213	EM	65	120	31	145	178	4800	5600	2,24	82,5		1,5	2,1
NUP 313	E	65	140	33	179	190	4300	5000	2,37	82,5		2,1	2,1
NUP 313	EM	65	140	33	179	190	4300	5000	2,37	82,5		2,1	2,1
NUP 2313	EM	65	140	48	245	285	4000	4800	3,35	82,5		2,1	2,1
NUP 413		65	160	37	178,1	125,7	3700	4500	3,68	89,3		2,1	1,5
NUP 413	M	65	160	37	178,1	125,7	3700	4500	3,68	89,3		2,1	1,5
N 214	E	70	125	24	118	136	5000	6000	1,15		133,5	1,5	1,5

Single Row Cylindrical Roller Bearings

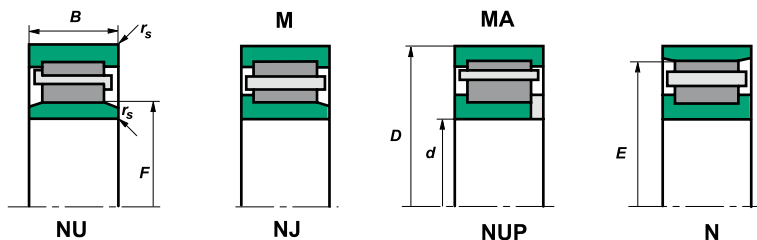

Bearing		ISO dimensions			Load ratings		Speed limits		Weight kg	Dimensions			
Type	Version	d mm	D	B	C kN	Co kN	Grease r/min	Oil r/min		F	E	r _s min	r _{1s} min
N 214	EM	70	125	24	118	136	5000	6000	1,17		133,5	1,5	1,5
N 314		70	150	35	149	156	4000	4800	2,8		130,0	2,1	2,1
N 314	M	70	150	35	149	156	4000	4800	2,8		130,0	2,1	2,1
N 414	M	70	180	42	240	253	3400	4000	5,46	152,0		3	3
NJ 214		70	125	24	83,7	96,1	5000	6000	1,17	84,5		1,5	1,5
NJ 214	E	70	125	24	118	136	5000	6000	1,18	83,5		1,5	1,5
NJ 214	EM	70	125	24	118	136	5000	6000	1,18	83,5		1,5	1,5
NJ 214	E	70	125	24	118	136	5000	6000	1,18	83,5		1,5	1,5
NJ 2214	E	70	125	31	143	174	4800	5600	1,55	83,5		1,5	1,5
NJ 2214	EM	70	125	31	143	174	4800	5600	1,52	83,5		1,5	1,5
NJ 2214	M	70	125	31	122	155	4800	5600	1,52	84,5		1,5	1,5
NJ 314		70	150	35	149	156	4000	4800	2,8	90,0		2,1	2,1
NJ 314	E	70	150	35	203	220	4000	4800	2,8	89,0		2,1	2,1
NJ 314	EM	70	150	35	203	220	4000	4800	2,8	89,0		2,1	2,1
NJ 314	M	70	150	35	149	156	4000	4800	2,8	90,0		2,1	2,1
NJ 2314	E	70	150	51	274	323	3800	4500	3,95	89,0		2,1	2,1
NJ 2314	EM	70	150	51	274	323	3800	4500	4	89,0		2,1	2,1
NJ 2314	M	70	150	51	210	242	3800	4500	4	90,0		2,1	2,1
NJ 414	M	70	180	42	240	253	3400	4000	5,28	100,0		3	3
NU 1014		70	110	20	57,8	69,6	6000	7000	0,732	80,0		1,1	1
NU 1014	M	70	110	20	57,8	69,6	6000	7000	0,732	80,0		1,1	1
NU 214		70	125	24	83,7	96,1	5000	6000	1,17	84,5		1,5	1,5
NU 214	E	70	125	24	118	136	5000	6000	1,17	83,5		1,5	1,5
NU 214	EM	70	125	24	118	136	5000	6000	1,17	83,5		1,5	1,5



Bearing		ISO dimensions			Load ratings		Speed limits		Weight kg	Dimensions			
Type	Version	d mm	D	B	C kN	Co kN	Grease r/min	Oil r/min		F	E	r _s min	r _{1s} min
NU 214	M	70	125	24	83,7	96,1	5000	6000	1,17	84,5		1,5	1,5
NU 2214	E	70	125	31	143	174	4800	5600	1,52	83,5		1,5	1,5
NU 2214	EM	70	125	31	143	174	4800	5600	1,52	83,5		1,5	1,5
NU 314		70	150	35	149	156	4000	4800	2,8	90,0		2,1	2,1
NU 314	EM	70	150	35	203	220	4000	4800	2,8	89,0		2,1	2,1
NU 314	E	70	150	35	204	222	4000	4800	2,73	89,0		2,1	1,5
NU 314	M	70	150	35	149	156	4000	4800	2,8	90,0		2,1	2,1
NU 2314	E	70	150	51	274	323	3800	4500	3,95	89,0		2,1	2,1
NU 2314	EM	70	150	51	274	323	3800	4500	4	89,0		2,1	2,1
NU 2314	M	70	150	51	210	242	3800	4500	4	90,0		2,1	2,1
NU 414	M	70	150	42	240	253	3400	4000	5,26	100,0		3	3
NUP 214	E	70	125	24	118	136	5000	6000	1,18	83,5		1,5	1,5
NUP 214	EM	70	125	24	118	136	5000	6000	1,18	83,5		1,5	1,5
NUP 2214	E	70	125	31	143	174	4800	5600	1,57	83,5		1,5	1,5
NUP 2214	EM	70	125	31	143	174	4800	5600	1,57	83,5		1,5	1,5
NUP 2214	EM.	70	125	31	157	197	4400	5300	1,7	83,5		1,5	1,5
NUP 314	EM	70	150	35	203	220	4000	4800	2,8	89,0		2,1	2,1
NUP 314	ENM	70	150	35	203	220	4000	4800	2,8	89,0		2,1	2,1
NUP 314	E	70	150	35	204	222	4000	4800	2,73	89,0		2,1	1,5
NUP 2314	E	70	150	51	274	323	3800	4500	3,95	89,0		2,1	2,1
NUP 414	M	70	180	42	240	253	3400	4000	5,46	100,0		3	3
N 215		75	130	25	92,5	106	4800	5600	1,28		116,5	1,5	1,5
N 215	EM	75	130	25	129	155	4800	5600	1,24		118,5	1,5	1,5
N 315		75	160	37	190	205	4000	4800	3,3		139,5	2,1	2,1

Single Row Cylindrical Roller Bearings

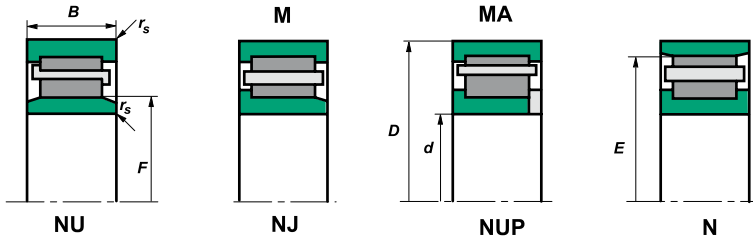

Bearing		ISO dimensions			Load ratings		Speed limits		Weight kg	Dimensions			
Type	Version	d mm	D	B	C kN	Co kN	Grease r/min	Oil r/min		F	E	r _s min	r _{1s} min
N 315	M	75	160	37	190	205	4000	4800	3,3		139,5	2,1	2,1
NJ 215		75	130	25	92,5	106	4800	5600	1,28	88,5		1,5	1,5
NJ 215	E	75	130	25	129	155	4800	5600	1,28	88,5		1,5	1,5
NJ 215	EM	75	130	25	129	155	4800	5600	1,28	88,5		1,5	1,5
NJ 215	EM.	75	130	25	125	155	4000	5000	1,27	88,5		1,5	1,5
NJ 2215		75	130	31	133	167	4000	4800	1,55	88,5		1,5	1,5
NJ 315	E	75	160	37	239	261	4000	4800	3,32	95,0		2,1	2,1
NJ 315	EM	75	160	37	239	261	4000	4800	3,3	95,0		2,1	2,1
NJ 315	M	75	160	37	190	205	4000	4800	3,3	95,5		2,1	2,1
NJ 2315	EM	75	160	55	329	395	4000	4800	4,95	95,0		2,1	2,1
NJ 2315	E	75	160	55	329	395	4000	4800	4,95	95,0		2,1	2,1
NJ 2315	M	75	160	55	258	302	4000	4800	4,95	95,5		2,1	2,1
NJ 415		75	190	45	277	294	4000	4800	6,44	104,5		3	3
NJ 415	M	75	190	45	277	294	4000	4800	6,44	104,5		3	3
NU 215		75	130	25	92,5	106	4800	5600	1,28	88,5		1,5	1,5
NU 215	E	75	130	25	129	155	4800	5600	1,28	88,5		1,5	1,5
NU 215	EM	75	130	25	129	155	4800	5600	1,28	88,5		1,5	1,5
NU 2215		75	130	31	133	167	4000	4800	1,55	88,5		1,5	1,5
NU 2215	EM	75	130	31	151	190	4000	4800	1,8	88,5		1,5	1,5
NU 2215	M	75	130	31	133	167	4000	4800	1,6	88,5		1,5	1,5
NU 315	E	75	160	37	239	261	4000	4800	3,24	95,0		2,1	2,1
NU 315	EM	75	160	37	239	261	4000	4800	3,24	95,0		2,1	2,1
NU 315	M	75	160	37	190	205	4000	4800	3,3	95,5		2,1	2,1
NU 2315	E	75	160	55	329	302	4000	4800	4,95	95,0		2,1	2,1



Bearing		ISO dimensions			Load ratings		Speed limits		Weight kg	Dimensions			
Type	Version	d mm	D	B	C kN	Co kN	Grease r/min	Oil r/min		F	E	r _s min	r _{1s} min
NU 2315	M	75	160	55	258	302	4000	4800	4,95	95,5		2,1	2,1
NU 415		75	190	45	277	294	4000	4800	6,44	104,5		3	3
NU 415	M	75	190	45	277	294	4000	4800	6,44	104,5		3	3
NUP 215	E	75	130	25	129	155	4800	5600	1,31	88,5		1,5	1,5
NUP 2215		75	130	31	133	167	4000	4800	1,55	88,5		1,5	1,5
NUP 2215	EM	75	130	31	151	190	4000	4800	1,8	88,5		1,5	2,1
NUP 315	E	75	160	37	239	261	4000	4800	3,3	95,0		2,1	2,1
NUP 315	EM	75	160	37	239	261	4000	4800	3,3	95,0		2,1	2,1
NUP 415		75	190	45	277	294	4000	4800	6,44	104,5		3	3
N 216		80	140	26	106	122	4300	5000	1,54		125,3	2	2
N 216	E	80	140	26	139	166	4300	5000	1,51		127,3	2	2
N 216	EM	80	140	26	139	166	4300	5000	1,51		127,3	2	2
N 316		80	170	39	190	207	3600	4300	3,93		147,0	2,1	2,1
N 316	M	80	170	39	190	207	3600	4300	3,93		147,0	2,1	2,1
N 2316		80	170	58	274	332	3600	4300	5,89		147,0	2,1	2,1
NJ 216		80	140	26	106	122	4300	5000	1,54	95,3		2	2
NJ 216	E	80	140	26	139	166	4300	5000	1,54	95,3		2	2
NJ 2216	E	80	140	33	179	231	4300	5000	2	95,3		2	2
NJ 2216	EM	80	140	33	179	231	4300	5000	2	95,3		2	2
NJ 2216	M	80	140	33	147	186	4300	5000	2	95,3		2	2
NJ 316		80	170	39	190	207	3600	4300	3,93	103,0		2,1	2,1
NJ 316	E	80	170	39	253	277	3600	4300	4,02	101,0		2,1	2,1
NJ 316	M	80	170	39	190	207	3600	4300	3,93	103,0		2,1	2,1
NJ 2316	E	80	170	58	353	426	3600	4300	5,89	101,0		2,1	2,1

Single Row Cylindrical Roller Bearings

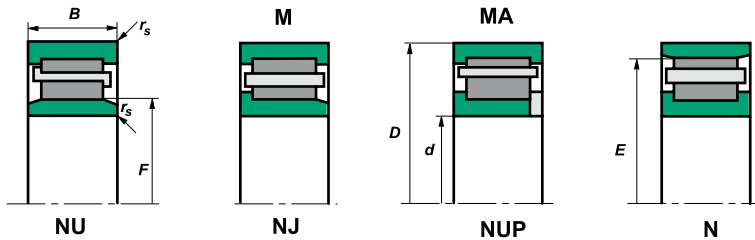

Bearing		ISO dimensions			Load ratings		Speed limits		Weight kg	Dimensions			
Type	Version	d mm	D	B	C kN	Co kN	Grease r/min	Oil r/min		F	E	r _s min	r _{1s} min
NJ 2316	M	80	170	58	274	332	3400	4200	5,89	103,0		2,1	2,1
NJ 416	M	80	200	48	316	339	3000	3600	8,23	110,0		3	3
NU 1016	M	80	125	22	68,2	85,3	5200	6200	1,03	68,2		1,1	1
NU 216		80	140	26	106	122	4300	5000	1,54	95,3		2	2
NU 216	E	80	140	26	139	166	4300	5000	1,51	95,3		2	2
NU 216	EM	80	140	26	139	166	4300	5000	1,51	95,3		2	2
NU 216	M	80	140	26	106	122	4300	5000	1,54	95,3		2	2
NU 2216	EM	80	140	33	179	231	4300	5000	2	95,3		2	2
NU 2216	M	80	140	33	147	186	4300	5000	2	95,3		2	2
NU 316		80	170	39	190	207	3600	4300	3,93	103,0		2,1	2,1
NU 316	E	80	170	39	253	277	3600	4300	3,93	101,0		2,1	2,1
NU 316	EM	80	170	39	253	277	3600	4300	3,93	101,0		2,1	2,1
NU 316	M	80	170	39	190	207	3600	4300	3,93	103,0		2,1	2,1
NU 2316	M	80	170	58	274	332	3400	4200	5,89	103,0		2,1	2,1
NU 2316	EM	80	170	58	275	332	3400	4300	6,6	103,0		2,1	2,1
NU 2316	EMA	80	170	58	353	426	3400	4300	6,7	103,0		2,1	2,1
NU 416		80	200	48	316	339	3000	3600	8,23	110,0		3	3
NU 416	M	80	200	48	316	339	3000	3600	8,23	110,0		3	3
NUP 216	E	80	140	26	139	166	4300	5000	1,6	95,3		2	2
NUP 216	M	80	140	26	119	141	3800	4800	1,78	95,3		2	2
NUP 2216	EM	80	140	33	179	231	4300	5000	2	95,3		2	2,1
NUP 2216	M	80	140	33	147	186	4300	5000	2	95,3		2	2
NUP 316		80	170	39	190	207	3600	4300	3,93	103,0		2,1	2,1
NUP 316	M	80	170	39	190	207	3600	4300	3,93	103,0		2,1	2,1



Bearing		ISO dimensions			Load ratings		Speed limits		Weight kg	Dimensions			
Type	Version	d mm	D	B	C kN	Co kN	Grease r/min	Oil r/min		F	E	r _s min	r _{1s} min
NUP 2316	M	80	170	58	274	332	3400	4200	5,89	103,0		2,1	2,1
NUP 416		80	200	48	316	339	3000	3600	8,23	110,0		3	3
NUP 416	M	80	200	48	316	339	3000	3600	8,23	110,0		3	3
N 217		85	150	28	121	141	4300	5000	1,89		133,8	2	2
N 217	M	85	150	28	121	141	4300	5000	1,9		133,8	2	2
N 317		85	180	41	210	226	3400	4000	4,41		156,0	3	3
N 317	M	85	180	41	210	226	3400	4000	4,68		156,0	3	3
N 1017	M	85	130	22	70,6	89,8	4800	5700	1,89		96,5	1,1	1
NJ 217		85	150	28	121	141	4300	5000	1,89	101,8		2	2
NJ 217	E	85	150	28	164	194	4300	5000	1,95	100,5		2	2
NJ 217	EM	85	150	28	164	194	4300	5000	1,95	100,5		2	2
NJ 217	EM.	85	150	28	168	200	3600	4500	2,19	100,5		2	2
NJ 217	M	85	150	28	121	141	4300	5000	1,89	101,8		2	2
NJ 2217	E	85	150	36	215	274	3600	4300	2,55	100,5		2	2
NJ 2217	EM	85	150	36	215	274	3600	4300	2,48	100,5		2	2
NJ 317		85	180	41	210	226	3400	4000	4,68	108,0		3	3
NJ 317	E	85	180	41	288	325	3400	4000	4,64	108,0		3	3
NJ 317	EM	85	180	41	288	325	3400	4000	4,68	108,0		3	3
NJ 317	M	85	180	41	210	226	3400	4000	4,68	108,0		3	3
NJ 2317	E	85	180	60	368	446	3400	4000	6,88	108,0		3	3
NJ 2317	EM	85	180	60	368	446	3400	4000	6,85	108,0		3	3
NJ 2317	M	85	180	60	318	386	3200	4000	7,56	108,0		3	3
NJ 417	M	85	210	52	357	384	2800	3400	9,81	113,0		4	4
NU 1017	M	85	130	22	70,6	89,8	4800	5700	1,066	96,5		1,1	1

Single Row Cylindrical Roller Bearings

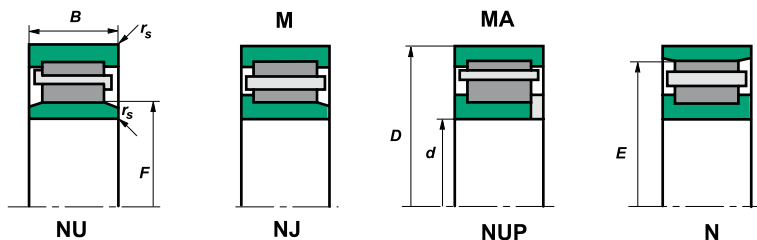

Bearing		ISO dimensions			Load ratings		Speed limits		Weight kg	Dimensions			
Type	Version	d mm	D	B	C kN	Co kN	Grease r/min	Oil r/min		F	E	r _s min	r _{1s} min
NU 217		85	150	28	121	141	4300	5000	1,89	101,8		2	2
NU 217	E	85	150	28	164	194	4300	5000	1,89	100,5		2	2
NU 217	EM	85	150	28	164	194	4300	5000	1,89	100,5		2	2
NU 217	M	85	150	28	121	141	4300	5000	1,89	101,8		2	2
NU 2217	EM	85	150	36	215	274	3600	4300	2,48	100,5		2	2
NU 317		85	180	41	210	226	3400	4000	4,52	108,0		3	3
NU 317	EM	85	180	41	288	325	3400	4000	4,68	108,0		3	3
NU 317	M	85	180	41	210	226	3400	4000	4,52	108,0		3	3
NU 2317	E	85	180	60	368	446	3400	4000	6,88	108,0		3	3
NU 2317	EM	85	180	60	368	446	3400	4000	6,85	108,0		3	3
NU 417	M	85	210	52	357	384	2800	3400	8,5	113,0		4	4
NUP 217		85	150	28	121	141	4300	5000	1,89	101,8		2	2
NUP 217	E	85	150	28	164	194	4300	5000	1,89	100,5		2	2
NUP 217	EM	85	150	28	164	194	4300	5000	1,89	100,5		2	2
NUP 217	M	85	150	28	121	141	4300	5000	1,89	101,8		2	2
NUP 2217	EM	85	150	36	219	281	3600	4300	2,9	100,5		2	2
NUP 317	EM	85	180	41	388	325	3400	4000	4,68	108,0		3	3
NUP 2317		85	180	60	297	353	3400	4000	6,88	108,0		3	3
NUP 2317	EM	85	180	60	368	446	3400	4000	6,85	108,0		3	3
N 218		90	160	30	149	174	3800	4500	2,36		143,0	2	2
N 218	EM	90	160	30	180	215	3800	4500	2,28		145,0	2	2
N 218	M	90	160	30	149	174	3800	4500	2,36		143,0	2	2
N 318		90	190	43	237	261	3200	3800	5,42		165,0	3	3
N 318	EM	90	190	43	322	261	3200	3800	5,38		169,5	3	3



Bearing		ISO dimensions			Load ratings		Speed limits		Weight kg	Dimensions			
Type	Version	d mm	D	B	C kN	Co kN	Grease r/min	Oil r/min		F	E	r ₁₅ min	r ₁₅ min
N 318	M	90	190	43	237	261	3200	3800	5,38		165,0	3	3
NJ 218		90	160	30	149	174	3800	4500	2,36	107,0		2	2
NJ 218	E	90	160	30	180	215	3800	4500	2,34	107,0		2	2
NJ 218	EM	90	160	30	180	215	3800	4500	2,36	107,0		2	2
NJ 218	EM.	90	160	30	170	203	3400	4300	2,63	107,0		2	2
NJ 2218		90	160	40	214	277	3200	3800	3,18	107,0		2	2
NJ 2218	M	90	160	40	214	277	3200	3800	3,18	107,0		2	2
NJ 318		90	190	43	237	261	3200	3800	5,51	115,0		3	3
NJ 318	E	90	190	43	322	349	3200	3800	5,42	113,5		3	3
NJ 318	EM	90	190	43	322	349	3200	3800	5,42	113,5		3	3
NJ 318	M	90	190	43	237	261	3200	3800	5,51	115,0		3	3
NJ 2318		90	190	64	342	420	3000	3600	8,15	115,0		3	3
NJ 2318	E	90	190	64	405	486	3000	3600	8,01	113,5		3	3
NJ 2318	EM	90	190	64	405	486	3000	3600	8,01	113,5		3	3
NJ 2318	EM.	90	190	64	289	349	3000	3800	8,7	113,5		3	3
NJ 2318	M	90	190	64	342	420	3000	3600	8,01	115,0		3	3
NJ 418		90	225	54	393	427	2200	2800	11,7	123,5		4	4
NJ 418	M	90	225	54	393	427	2200	2800	11,7	123,5		4	4
NU 1018	M	90	140	24	83,8	107	4500	5300	1,4	103,0		1,5	1,1
NU 218		90	160	30	149	174	3800	4500	2,36	107,0		2	2
NU 218	E	90	160	30	180	215	3800	4500	2,28	107,0		2	2
NU 218	EM	90	160	30	180	215	3800	4500	2,28	107,0		2	2
NU 218	M	90	160	30	149	174	3800	4500	2,28	107,0		2	2
NU 2218		90	160	40	214	277	3200	3800	3,18	107,0		2	2

Single Row Cylindrical Roller Bearings

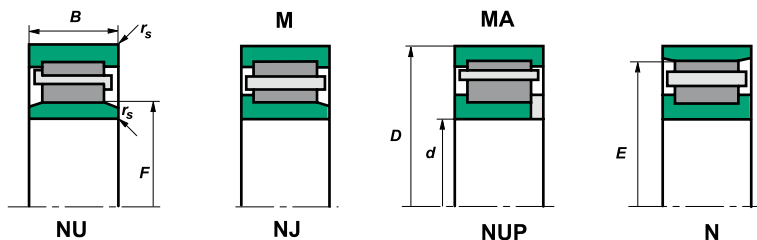

Bearing		ISO dimensions			Load ratings		Speed limits		Weight kg	Dimensions			
Type	Version	d mm	D	B	C kN	Co kN	Grease r/min	Oil r/min		F	E	r _s min	r _{1s} min
NU 2218	M	90	160	40	214	277	3200	3800	3,18	107,0		2	2
NU 318	E	90	190	43	322	349	3200	3800	5,38	113,5		3	3
NU 318	EM	90	190	43	322	349	3200	3800	5,38	113,5		3	3
NU 318	M	90	190	43	237	261	3200	3800	5,42	115,0		3	3
NU 2318	E	90	190	43	405	486	3000	3600	8,01	113,5		3	3
NU 2318	EM	90	190	43	405	486	3000	3600	8,01	113,5		3	3
NU 2318	M	90	190	64	342	420	3000	3600	7,9	115,0		3	3
NU 418		90	225	54	393	427	2800	3400	11,7	123,5		4	4
NU 418	M	90	225	54	393	427	2800	3400	11,7	123,5		4	4
NUP 218		90	160	30	149	174	3800	4500	2,36	107,0		2	2
NUP 218	E	90	160	30	180	215	3800	4500	2,41	107,0		2	2
NUP 218	EM	90	160	30	180	215	3800	4500	2,36	107,0		2	2
NUP 2218		90	160	40	214	277	3200	3800	3,18	107,0		2	2
NUP 2218	M	90	160	40	214	277	3200	3800	3,18	107,0		2	2
NUP 318	E	90	190	43	322	349	3200	3800	5,42	113,5		3	3
NUP 318	EM	90	190	43	322	349	3200	3800	5,42	113,5		3	3
NUP 2318	E	90	190	64	405	486	3000	3600	8,01	115,0		3	3
NUP 2318	M	90	190	64	342	420	3000	3600	8,25	115,0		3	3
NUP 418		90	225	54	393	427	2200	2800	11,7	115,0		4	4
N 219		95	170	32	166	195	3800	4500	2,83		113,5	2,1	2,1
N 319		95	200	45	255	284	3000	3600	6,28		173,5	3	3
N 319	M	95	200	45	255	284	3000	3600	6,28		173,5	3	3
N 2319	M	95	200	67	390	491	2800	3400	9,3		173,5	3	3
N 419	M	95	240	55	416	465	2500	3000	13,8		133,5	4	4



Bearing		ISO dimensions			Load ratings		Speed limits		Weight kg	Dimensions			
Type	Version	d mm	D	B	C kN	Co kN	Grease r/min	Oil r/min		F	E	r _s min	r _{1s} min
NJ 219		95	170	32	210	249	3800	4500	2,83	113,5		2,1	2,1
NJ 219	M	95	170	32	166	195	3800	4500	2,83	113,5		2,1	2,1
NJ 2219	EM	95	170	43	272,7	348,8	3200	3800	3,93	113,5		2,1	2,1
NJ 2219	M	95	170	43	241	317	3200	3800	3,83	113,5		2,1	2,1
NJ 319		95	200	45	255	284	3000	3600	6,28	121,5		3	3
NJ 319	E	95	200	45	331	381	3000	3600	6,28	121,5		3	3
NJ 319	M	95	200	45	255	284	3000	3600	6,28	121,5		3	3
NJ 2319		95	200	67	390	491	2800	3400	3,93	121,5		3	3
NJ 2319	M	95	200	67	390	491	2800	3400	3,93	121,5		3	3
NJ 2319	EM	95	200	67	394	496	2800	3600	11,02	121,5		3	3
NU 1019	M	95	145	24	85,3	114	4400	5200	1,44	108,0		1,5	1,1
NU 219		95	170	32	166	195	3800	4500	2,83	113,5		2,1	2,1
NU 219	E	95	170	32	210	249	3800	4500	2,83	112,5		2,1	2,1
NU 219	EM	95	170	32	210	249	3800	4500	2,83	112,5		2,1	2,1
NU 219	M	95	170	32	116	195	3800	4500	2,83	113,5		2,1	2,1
NU 2219	EM	95	170	43	272,7	348,8	3200	3800	3,93	113,5		2,1	2,1
NU 2219	M	95	170	43	241	317	3200	3800	3,93	113,5		2,1	2,1
NU 319		95	200	45	255	284	3000	3600	6,28	121,5		3	3
NU 319	M	95	200	45	255	284	3000	3600	6,28	121,5		3	3
NU 319	EM	95	200	45	311	351	3000	3600	7,76	121,5		3	3
NU 2319	M	95	200	67	390	491	2800	3400	3,93	121,5		3	3
NU 419	M	95	240	55	416	465	2500	3000	13,8	133,5		4	4
NUP 219		95	170	32	166	195	3800	4500	2,83	113,5		2,1	2,1
NUP 219	M	95	170	32	166	195	3800	4500	2,83	113,5		2,1	2,1

Single Row Cylindrical Roller Bearings

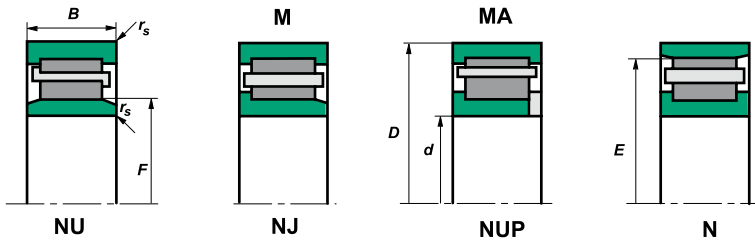

Bearing		ISO dimensions			Load ratings		Speed limits		Weight kg	Dimensions			
Type	Version	d mm	D	B	C kN	Co kN	Grease r/min	Oil r/min		F	E	r _s min	r _{1s} min
NUP 219	EM	95	170	32	210	249	3800	4500	2,83	113,5		2,1	2,1
NUP 2219	M	95	170	43	241	317	3200	3800	6,28	121,5		2,1	2,1
NUP 319		95	200	45	255	284	3000	3600	6,28	121,5		3	3
NUP 2319	M	95	200	67	390	491	2800	3400	9,3		121,5	3	3
N 220		100	180	34	181	215	3400	4000	3,32	160,0		2,1	2,1
N 220	EM	100	180	34	251	305	3200	3800	3,45				
N 220	M	100	180	34	181	215	3400	4000	3,38	160,0		2,1	2,1
N 2220		100	180	46	270	360	3000	3600	4,77	160,0		2,1	2,1
N 2220	EM	100	180	46	336	450	3200	3800	4,9				
N 320		100	215	47	295	332	3000	3600	7,66		185,5	3	3
N 320	EM	100	215	47	391	270	3000	3600	7,7		191,5	3	3
N 320	M	100	215	47	295	332	3000	3600	7,66		185,5	3	3
NJ 220		100	180	34	181	215	3400	4000	3,37	120,0		2,1	2,1
NJ 220	EM	100	180	34	248,6	305,5	3200	3800	3,79	119,0		2,1	2,1
NJ 220	E	100	180	34	248,6	305,5	3200	3800	5,55	119,0		2,1	2,1
NJ 220	M	100	180	34	181	215	3400	4000	3,44	120,0		2,1	2,1
NJ 2220		100	180	46	270	360	3000	3600	4,77	120,0		2,1	2,1
NJ 2220	EM	100	180	46	318	418,2	3000	3600	4,77	119,0		2,1	2,1
NJ 2220	EM.	100	180	46	326	472	3200	3800	5,43	119,0		2,1	2,1
NJ 2220	M	100	180	46	270	360	3000	3600	4,67	120,0		2,1	2,1
NJ 320		100	215	47	295	332	3000	3600	7,7	129,5		3	3
NJ 320	E	100	215	47	381	427	3000	3600	7,66	127,5		3	3
NJ 320	EM	100	215	47	381	427	3000	3600	7,66	127,5		3	3
NJ 320	M	100	215	47	295	332	3000	3600	7,7	129,5		3	3



Bearing		ISO dimensions			Load ratings		Speed limits		Weight kg	Dimensions			
Type	Version	d mm	D	B	C kN	Co kN	Grease r/min	Oil r/min		F	E	r ₁₅ min	r ₁₅ min
NJ 2320		100	215	73	457	584	3600	3200	12	129,5		3	3
NJ 2320	E	100	215	73	568	714	2600	3200	12	127,5		3	3
NJ 2320	EM	100	215	73	568	714	2600	3200	12	127,5		3	3
NJ 2320	M	100	215	73	457	584	2600	3200	12	129,5		3	3
NJ 420	EM	100	250	58	429	475	2400	3000	14				
NJ 420	M	100	250	58	440	488	2200	2800	1,88	119,5		4	4
NU 1020		100	150	24	89,6	120	4300	5000	1,46	113,0		1,5	1,1
NU 1020	M	100	150	24	89,6	120	4300	5000	1,46	113,0		1,5	1,1
NU 220		100	180	34	181	215	3400	4000	3,38	120,0		2,1	2,1
NU 220	E	100	180	34	248,6	305,5	3200	3800	3,49	119,0		2,1	2,1
NU 220	EM	100	180	34	248,6	305,5	3200	3800	3,49	119,0		2,1	2,1
NU 220	EM.	100	180	34	208	226	3000	3800	3,14	119,0		2,1	2,1
NU 220	E	100	180	34	248,6	305,5	3200	3800	3,49	119,0		2,1	2,1
NU 220	M	100	180	34	181	215	3400	4000	3,47	120,0		2,1	2,1
NU 2220		100	180	46	270	360	3000	3600	4,77	120,0		2,1	2,1
NU 2220	EM	100	180	46	336	450	3200	3800	4,75				
NU 2220	M	100	180	46	270	360	3000	3600	4,67	120,0		2,1	2,1
NU 320		100	215	47	295	332	3000	3600	7,7	129,5		2,1	2,1
NU 320	EM	100	215	47	381	427	3000	3600	7,66	127,5		3	3
NU 320	M	100	215	47	295	332	3000	3600	7,7	129,5		3	3
NU 2320		100	215	73	457	584	2600	3200	12	129,5		3	3
NU 2320	EM	100	215	73	568	714	2600	3200	12	127,5		3	3
NU 2320	M	100	215	73	457	584	2600	3200	11,9	129,5		3	3
NU 420	EM	100	250	58	429	475	2400	3000	14				

Single Row Cylindrical Roller Bearings

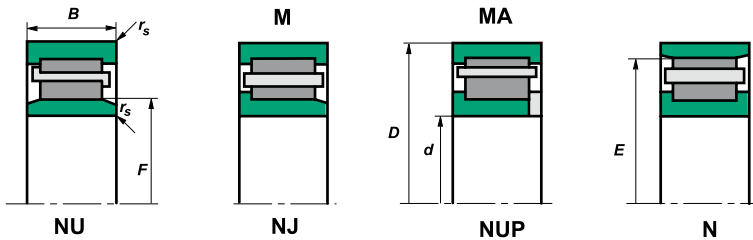

Bearing		ISO dimensions			Load ratings		Speed limits		Weight kg	Dimensions			
Type	Version	d mm	D	B	C kN	Co kN	Grease r/min	Oil r/min		F	E	r _s min	r _{1s} min
NU 420	M	100	250	58	440	488	2200	2800	14	139,0		4	4
NUP 220		100	180	34	181	215	3400	4000	3,56	120,0		2,1	2,1
NUP 220	E	100	180	34	248,6	305,5	3200	3800	3,44	120,0		2,1	2,1
NUP 220	M	100	180	34	181	215	3400	4000	3,44	120,0		2,1	2,1
NUP 2220		100	180	46	270	360	3000	3600	4,77	120,0		2,1	2,1
NUP 2220	M	100	180	46	270	360	3000	3600	4,77	120,0		2,1	2,1
NUP 320		100	215	47	295	332	3000	3600	7,66	129,5		3	3
NUP 320	M	100	215	47	295	332	3000	3600	7,66	129,5		3	3
NUP 2320		100	215	73	457	584	2600	3200	11,9	127,5		3	3
NUP 2320	M	100	215	73	457	584	2600	3200	14	139,0		3	3
N 221	M	105	190	36	210	256	3200	3800	4,04		126,8	2,1	2,1
N 321	M	105	225	49	354	408	2400	3000	9,09		195,0	3	3
NJ 221	M	105	190	36	210	256	3200	3800	4,04	168,8		2,1	2,1
NJ 321	M	105	225	49	354	408	2400	3000	9,09	135,0		3	3
NJ 421	M	105	260	60	488	545	2200	2800	17,4	144,5		4	4
NU 1021	M	105	160	26	101,5	135,3	3800	4500	4	126,8		2	1,1
NU 221	M	105	190	36	210	256	3200	3800	4,04	126,8		2,1	2,1
NU 321	EM	105	225	49	418	469	2400	3000	9,09	133,0		3	3
NU 421	M	105	260	60	488	545	2200	2800	17,4	144,5		4	4
NUP 421	M	105	260	60	488	545	2200	2800	2,31	144,5		4	4
N 222		110	200	38	238	287	3000	3600	4,65		178,5	2,1	2,1
N 222	M	110	200	38	238	287	3000	3600	4,65		178,5	2,1	2,1
N 2222	EM	110	200	53	348	513	2800	3400	7,1				
N 2322	EM	110	240	80	682	900	2000	2600	18,23				



Bearing		ISO dimensions			Load ratings		Speed limits		Weight kg	Dimensions			
Type	Version	d mm	D	B	C kN	Co kN	Grease r/min	Oil r/min		F	E	r ₁₅ min	r ₁₅ min
N 2322	M	110	240	80	603	789	2200	2800	16,9		207,0	3	3
N 322	EM	110	240	50	409,4	575,3	2000	2600	11,34				
NJ 222		110	200	38	238	287	3000	3600	4,65	132,5		2,1	2,1
NJ 222	E	110	200	38	279	343	3000	3600	4,77	132,5		2,1	2,1
NJ 222	EM	110	200	38	279	343	3000	3600	4,85	132,5		2,1	2,1
NJ 222	M	110	200	38	238	287	3000	3600	4,65	132,5		2,1	2,1
NJ 2222		110	200	53	350	471	2600	3200	6,68	132,5		2,1	2,1
NJ 2222	EM	110	200	53	383	516	2800	3200	6,68	132,5		2,1	2,1
NJ 2222	M	110	200	53	350	471	2600	3200	6,68	132,5		2,1	2,1
NJ 322	E	110	240	50	443	513	2400	3000	10,6	143,0		3	3
NJ 322	EM	110	240	50	443	513	2400	3000	10,6	143,0		3	3
NJ 322	M	110	240	50	382	437	2400	3000	10,6	143,0		3	3
NJ 2322	E	110	240	80	667	868	2200	2800	16,9	143,0		3	3
NJ 2322	EM	110	240	80	667	868	2200	2800	16,9	143,0		3	3
NJ 2322	M	110	240	80	603	789	2200	2800	16,9	143,0		3	3
NJ 422	EM	110	280	65	523	585	2000	2600	20				
NJ 422	M	110	280	65	583	672	2200	2800	20,8	155,0		4	4
NU 1022	M	110	170	28	127	167	3600	4500	2,31	125,0		2	1,1
NU 222		110	200	38	238	287	3000	3600	4,65	132,5		2,1	2,1
NU 222	EM	110	200	38	279	343	3000	3600	4,77	132,5		2,1	2,1
NU 222	M	110	200	38	238	287	3000	3600	4,65	132,5		2,1	2,1
NU 2222		110	200	53	350	471	2600	3200	7,22	132,5		2,1	2,1
NU 2222	EM	110	200	53	383	516	2800	3400	6,68	132,5		2,1	2,1
NU 2222	M	110	200	53	350	471	2600	3200	6,68	132,5		2,1	2,1

Single Row Cylindrical Roller Bearings

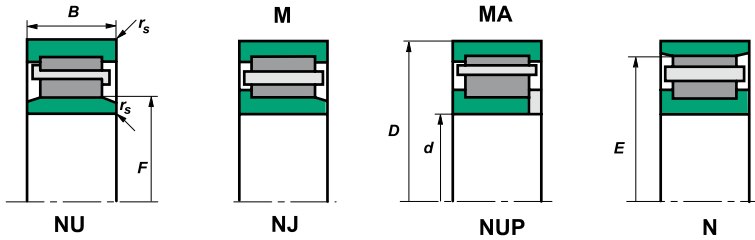

Bearing		ISO dimensions			Load ratings		Speed limits		Weight kg	Dimensions			
Type	Version	d mm	D	B	C kN	Co kN	Grease r/min	Oil r/min		F	E	r _s min	r _{1s} min
NU 322	E	110	240	50	443	513	2400	3000	10,6	143,0		3	3
NU 322	EM	110	240	50	443	513	2400	3000	10,6	143,0		3	3
NU 322	M	110	240	50	382	437	2400	3000	10,6	143,0		3	3
NU 2322	EM	110	240	80	667	868	2200	2800	19	143,0		3	3
NU 2322	M	110	240	80	603	789	2200	2800	16,9	143,0		3	3
NU 422	EM	110	280	65	523	585	2000	2600	20				
NU 422	M	110	280	65	583	672	2200	2800	20,8	155,0		4	4
NUP 222		110	200	38	238	287	3000	3600	4,84	132,5		2,1	2,1
NUP 222	E	110	200	38	279	343	3000	3600	4,85	132,5		2,1	2,1
NUP 222	EM	110	200	38	279	343	3000	3600	4,85	132,5		2,1	2,1
NUP 222	M	110	200	38	238	287	3000	3600	4,65	132,5		2,1	2,1
NUP 2222		110	200	53	350	471	2600	3200	6,68	132,5		2,1	2,1
NUP 2222	M	110	200	53	350	471	2600	3200	7,14	132,5		2,1	2,1
NUP 322	E	110	240	50	443	513	2400	3000	10,6	143,0		3	3
NUP 322	EM	110	240	50	485	577	2400	3000	10,6	143,0		3	3
NUP 322	M	110	240	50	382	437	2400	3000	10,6	143,0		3	3
NUP 2322	M	110	240	80	604	789	2200	2800	16,9	143,0		3	3
NUP 422	M	110	280	65	583	672	2200	2400	20,8	155,0		4	4
NJ 323	M	115	250	53	476	547	2700	3300	13,3	149,5		3	3
N 1024	M	120	180	28	139	192	3400	4000	2,55		165,0	2	1,1
N 224	EM	120	215	40	359,4	461	2400	3000	6,3				
N 224	M	120	215	40	258	361	2800	3400	5,65		191,5	2,1	2,1
N 324	EM	120	260	55	549	644	2200	2800	13,1		230,0	3	3
N 324	M	120	260	55	441	498	2200	2800	13,1		226,0	3	3



Bearing		ISO dimensions			Load ratings		Speed limits		Weight kg	Dimensions			
Type	Version	d mm	D	B	C kN	Co kN	Grease r/min	Oil r/min		F	E	r ₁₅ min	r ₁₅ min
N 424	M	120	310	72	677	776	1800	2200	30,6		260,0	5	5
NJ 224		120	215	40	258	361	2800	3400	5,8	143,5		2,1	2,1
NJ 224	E	120	215	40	331	415	2800	3400	5,8	143,5		2,1	2,1
NJ 224	EM	120	215	40	329	412	2800	3400	5,54	143,5		2,1	2,1
NJ 224	M	120	215	40	258	361	2800	3400	5,54	143,5		2,1	2,1
NJ 2224		120	215	58	382	523	2400	3000	8,29	143,5		2,1	2,1
NJ 2224	EM	120	215	58	413	622	2400	3000	9,14	143,5		2,1	2,1
NJ 2224	EM.	120	215	58	443	658	2400	3000	9,53	143,5		2,1	2,1
NJ 2224	M	120	215	58	382	523	2400	3000	8,29	143,5		2,1	2,1
NJ 324		120	260	55	441	498	2200	2800	13,3	154,0		3	3
NJ 324	EM	120	260	55	549	644	2200	2800	13,3	154,0		3	3
NJ 324	M	120	260	55	441	498	2200	2800	13,3	154,0		3	3
NJ 2324		120	260	86	702	907	2000	2600	23,6	154,0		3	3
NJ 2324	EM	120	260	86	765,7	1080,9	1900	2400	24,03				
NJ 2324	M	120	260	86	702	907	2000	2600	23,2	154,0		3	3
NJ 424		120	310	72	677	776	1800	2200	28	170,0		5	5
NJ 424	EM	120	310	72	644	735	1900	2400	28,5				
NJ 424	M	120	310	72	677	776	1800	2200	30,6	260,0		5	5
NU 1024	M	120	180	28	139	192	3400	4000	2,55	135,0		2	1,1
NU 224		120	215	40	258	361	2800	3400	5,65	143,5		2,1	2,1
NU 224	EM	120	215	40	359,4	461	2400	3000	6,35				
NU 224	M	120	215	40	258	361	2800	3400	5,65	143,5		2,1	2,1
NU 2224		120	215	58	382	523	2400	3000	8,29	143,5		2,1	2,1
NU 2224	EM	120	215	58	413	622	2400	3000	9				

Single Row Cylindrical Roller Bearings

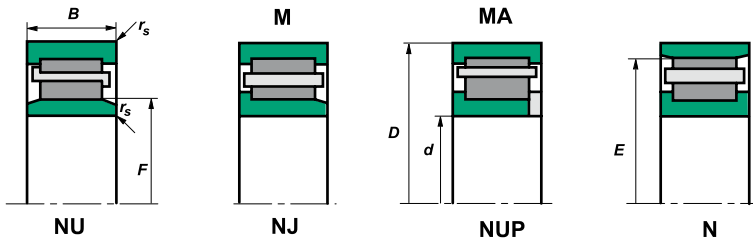

Bearing		ISO dimensions			Load ratings		Speed limits		Weight kg	Dimensions			
Type	Version	d mm	D	B	C kN	Co kN	Grease r/min	Oil r/min		F	E	r _s min	r _{1s} min
NU 2224	M	120	215	58	382	523	2400	3000	8,29	143,5		2,1	2,1
NU 324		120	260	55	441	498	2200	2800	13,3	154,0		3	3
NU 324	EM	120	260	55	549	644	2200	2800	13,3	154,0		3	3
NU 324	M	120	260	55	441	498	2200	2800	13,4	154,0		3	3
NU 2324	EM	120	260	86	765,7	1080,9	1900	2400	23,71				
NU 2324	M	120	260	86	702	907	2000	2600	23,2	154,0		3	3
NU 424	EM	120	310	72	644	735	1900	2400	28				
NU 424	M	120	310	72	677	776	1800	2200	30,6	260,0		5	5
NUP 224		120	215	40	258	361	2800	3400	5,65	143,5		2,1	2,1
NUP 224	M	120	215	40	258	361	2800	3400	5,65	143,5		2,1	2,1
NUP 2224		120	215	58	382	523	2400	3000	8,29	143,5		2,1	2,1
NUP 2224	M	120	215	58	382	523	2400	3000	8,29	143,5		2,1	2,1
NUP 324		120	260	55	441	498	2200	2800	13,7	154,0		3	3
NUP 324	EM	120	260	55	549	644	2200	2800	13,7	154,0		3	3
NUP 324	M	120	260	55	441	498	2200	2800	13,1	154,0		3	3
NUP 2324	M	120	260	86	702	907	2000	2600	30,6	154,0		3	3
WJ120/240	M	120	240	80	150	946	1484	2400	34,7	150,0		3	
WJP 120/240	M	120	240	80	150	946	1484	2400	34,7	150,0		3	
N 226	EM	130	230	40	326	446	2200	2800	7				
N 226	M	130	230	40	268	339	2400	3000	6,79		204,0	3	3
N 326	EM	130	280	58	607	722	2000	2600	16,4		247,0	4	4
N 326	M	130	280	58	520	607	2000	2600	16,5		243,0	4	4
NJ 1026	M	130	200	33	162	221	3000	3600	3,91	148,0		2	1,1
NJ 226		130	230	40	268	339	2400	3000	6,5	156,0		3	3



Bearing		ISO dimensions			Load ratings		Speed limits		Weight kg	Dimensions			
Type	Version	d mm	D	B	C kN	Co kN	Grease r/min	Oil r/min		F	E	r ₁₅ min	r ₁₅ min
NJ 226	E	130	230	40	356	443	2400	3000	6,79	153,5		3	3
NJ 226	EM	130	230	40	356	443	2400	3000	6,79	153,5		3	3
NJ 226	M	130	230	40	268	339	2400	3000	6,49	156,0		3	3
NJ 2226		130	230	64	395	560	2200	2800	10,3	156,0		3	3
NJ 2226	EM	130	230	64	523	726	2200	2800	10,3	153,5		3	3
NJ 2226	M	130	230	64	395	560	2200	2800	10,3	156,0		3	3
NJ 2226	MA	130	230	64	395	560	2200	2800	11,1	156,0		3	3
NJ 326		130	280	58	520	607	2000	2600	16,8	167,0		4	4
NJ 326	E	130	280	58	607	722	2000	2600	16,8	167,0		4	4
NJ 326	EM	130	280	58	607	722	2000	2600	16,5	167,0		4	4
NJ 326	M	130	280	58	520	607	2000	2600	16,5	167,0		4	4
NJ 326	M	130	280	58	520	607	2000	2600	16,5	167,0		4	4
NJ 2326		130	280	93	828	1106	1900	2400	29,9	167,0		4	4
NJ 2326	EM	130	280	93	791	1144	1800	2200	23,88				
NJ 2326	M	130	280	93	828	1106	1900	2400	29,44	167,0		4	4
NU 1026	M	130	200	33	163	221	3000	3600	3,91	148,0		2	1,1
NU 226		130	230	40	268	339	2400	3000	6,49	156,0		3	3
NU 226	EM	130	230	40	356	443	2400	3000	6,5	153,5		3	3
NU 226	M	130	230	40	268	339	2400	3000	6,64	156,0		3	3
NU 2226		130	230	64	395	560	2200	2800	10,3	156,0		3	3
NU 2226	EM	130	230	64	523	726	2200	2800	10,3	153,5		3	3
NU 2226	M	130	230	64	395	560	2200	2800	10,3	156,0		3	3
NU 326	E	130	280	58	607	722	2000	2600	16,5	167,0		4	4
NU 326	EM	130	280	58	607	722	2000	2600	16,5	167,0		4	4

Single Row Cylindrical Roller Bearings

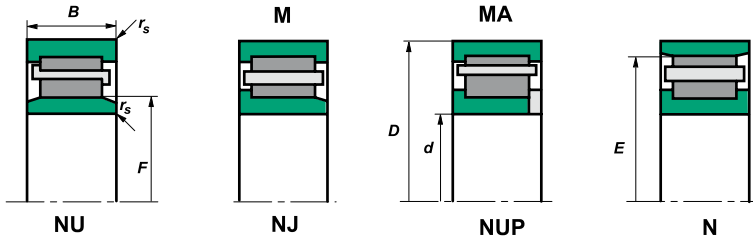

Bearing		ISO dimensions			Load ratings		Speed limits		Weight kg	Dimensions			
Type	Version	d mm	D	B	C kN	Co kN	Grease r/min	Oil r/min		F	E	r _s min	r _{1s} min
NU 326	M	130	280	58	520	607	2000	2600	16,5	167,0		4	4
NU 2326		130	280	93	828	1106	1900	2400	29,6	167,0		4	4
NU 2326	EM	130	280	93	909	1212	1900	2400	29,6	167,0		4	4
NU 2326	M	130	280	93	828	1106	1900	2400	29,6	167,0		4	4
NUP 226		130	230	40	268	339	2400	3000	6,49	156,0		3	3
NUP 226	M	130	230	40	268	339	2400	3000	6,79	156,0		3	3
NUP 2226		130	230	64	395	560	2200	2800	10,3	156,0		3	3
NUP 2226	M	130	230	64	395	560	2200	2800	10,3	156,0		3	3
NUP 2226	M	130	230	64	395	560	2200	2800	10,3	156,0		3	3
NUP 326	E	130	280	58	607	722	2000	2600	16,5	167,0		4	4
NUP 326	EM	130	280	58	607	722	2000	2600	16,4	167,0		4	4
NUP 326	M	130	280	58	520	607	2000	2600	16,9	167,0		4	4
NUP 2326		130	280	93	828	1106	1900	2400	29,6	167,0		4	4
N 228	EM	140	250	42	359	517	2000	2600	9,04				
N 328	EM	140	300	62	610	1214	1800	2200	22				
N 328	M	140	300	62	607	732	1900	2400	20,1		260,0	4	4
N 428	EM	140	360	82	868	1010	1300	1700	43,8				
NJ 1028	M	140	210	33	172	243	2800	3200	4,1	158,0		2	1,1
NJ 228	EM	140	250	42	372	479	2200	2800	8,55	169,0		3	3
NJ 228	M	140	250	42	307	391	2200	2800	8,55	169,0		3	3
NJ 2228	EM	140	250	68	572	830	2000	2600	13,7	169,0		3	3
NJ 2228	M	140	250	68	479	708	2000	2600	15,2	169,0		3	3
NJ 328	EM	140	300	62	610	1214	1800	2200	22,45				
NJ 328	M	140	300	62	607	732	1900	2400	22,5	180,0		4	4



Bearing		ISO dimensions			Load ratings		Speed limits		Weight kg	Dimensions			
Type	Version	d mm	D	B	C kN	Co kN	Grease r/min	Oil r/min		F	E	r _s min	r _{s15} min
NJ 2328	E	140	300	102	1130	1589	1800	2200	37,2	180,0		4	4
NJ 2328	EM	140	300	102	1130	1589	1800	2200	37,2	180,0		4	4
NJ 2328	M	140	300	102	913	1236	1800	2200	37,2	180,0		4	4
NJ 428	EM	140	360	82	868	1010	1300	1700	44,76				
NU 1028	M	140	210	33	172	243	2800	3200	4,1	158,0		2	1,1
NU 228	EM	140	250	42	372	479	2200	2800	8,35	169,0		3	3
NU 228	M	140	250	42	307	391	2200	2800	8,35	169,0		3	3
NU 2228	EM	140	250	68	543	780	2000	2600	15,2	169,0		3	3
NU 2228	M	140	250	68	479	708	2000	2600	15,2	169,0		3	3
NU 328	EM	140	300	62	703	861	1900	2400	20,2	180,0		4	4
NU 328	M	140	300	62	607	732	1900	2400	20,2	180,0		4	4
NU 2328	EM	140	300	102	1060	1500	1800	2200	36,1				
NU 2328	M	140	300	102	913	1236	1800	2200	37,2	180,0		4	4
NU 428	EM	140	360	82	868	1010	1300	1700	44,07				
NUP 228	EM	140	250	42	372	479	2200	2800	8,55	169,0		3	3
NUP 228	M	140	250	42	307	391	2200	2800	8,55	169,0		3	3
NUP 2228	M	140	250	68	479	708	2000	2600	15,2	169,0		3	3
NUP 328	EM	140	300	62	703	861	1900	2400	20,1	180,0		4	4
NUP 328	M	140	300	62	607	732	1900	2400	20,7	180,0		4	4
NUP 328	M	140	300	62	607	732	1900	2400	20,7	180,0		4	4
NUP 2328	M	140	300	102	913	1236	1800	2200	37,2	180,0		4	4
N 230	EM	150	270	45	386,6	554,8	1900	2400	11,2				
N 230	M	150	270	45	370	484	2000	2600	10,3		238,0	3	3
N 330	EM	150	320	65	688	921	1700	2000	25,78				

Single Row Cylindrical Roller Bearings

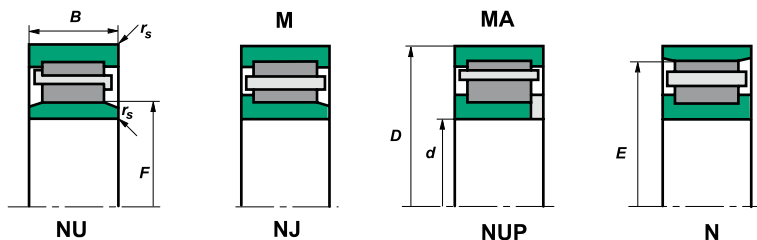

Bearing		ISO dimensions			Load ratings		Speed limits		Weight kg	Dimensions			
Type	Version	d mm	D	B	C kN	Co kN	Grease r/min	Oil r/min		F	E	r _s min	r _{1s} min
NJ 230	EM	150	270	45	422	550	2200	2800	10,6	182,0		3	3
NJ 230	M	150	270	45	370	484	2000	2600	10,6	182,0		3	3
NJ 2230	EM	150	270	73	573,7	922	1900	2400	18,61				
NJ 2230	M	150	270	73	565	836	1900	2400	19,2	182,0		3	3
NJ 330	EM	150	320	65	688	921	1700	2000	26,32				
NJ 330	M	150	320	65	667	813	1700	2000	27	193,0		4	4
NJ 2330	EM	150	320	108	1055	1607	1700	2000	43,5				
NJ 2330	M	150	320	108	1022	1409	1700	2000	44,7	193,0		4	4
NU 1030	M	150	225	35	190	271	2600	3200	4,83	169,5		2,1	1,5
NU 230	EM	150	270	45	422	550	2200	2800	11,68	182,0		3	3
NU 230	M	150	270	45	370	484	2000	2600	10,3	182,0		3	3
NU 230	MA	150	270	45	370	484	2000	2600	10,3	182,0		3	3
NU 2230	EM	150	270	73	573,7	922	1900	2400	18,25				
NU 2230	M	150	270	73	565	836	1900	2400	18,7	182,0		3	3
NU 330	EM	150	320	65	798	988	1700	2000	27	193,0		4	4
NU 330	M	150	320	65	667	813	1700	2000	27	193,0		4	4
NU 2330	EM	150	320	108	1055	1607	1700	2000	42,98				
NU 2330	M	150	320	108	1022	1409	1700	2000	44,7	193,0		4	4
NUP 230	M	150	270	45	370	484	2000	2600	10,9	182,0		3	3
NUP 2230	M	150	270	73	565	836	1900	2400	19,7	182,0		3	3
NUP 330	M	150	320	65	667	813	1700	2000	27,4	193,0		4	4
N 232	EM	160	290	48	351	479	1800	2200	14,02				
N 332	EM	160	340	68	738	978	1500	1800	30,3				
N 332	M	160	340	68	702	883	1500	1800	32	292,0		4	4



Bearing		ISO dimensions			Load ratings		Speed limits		Weight kg	Dimensions			
Type	Version	d mm	D	B	C kN	Co kN	Grease r/min	Oil r/min		F	E	r _s min	r _{1s} min
NJ 1032	M	160	240	38	230	331	2400	3000	6,2	180,0		2,1	1,5
NJ 232	EM	160	290	48	498	666	1900	2400	14,6	195,0		3	3
NJ 232	M	160	290	48	440	591	1900	2400	14,6	195,0		3	3
NJ 2232	EM	160	290	80	767	1109	1700	2000	24,3	193,0		3	3
NJ 2232	M	160	290	80	650	978	1700	2000	24,3	195,0		3	3
NJ 332	EM	160	340	68	738	978	1500	1800	31,01				
NJ 332	M	160	340	68	702	883	1600	1900	31,7	208,0		4	4
NJ 2332	EM	160	340	114	1128	1689	1500	1800	51,5				
NJ 2332	M	160	340	114	1069	1522	1600	1900	53,2	208,0		4	4
NU 1032	M	160	240	38	230	328	2400	3000	6,2	180,0		2,1	1,5
NU 232	EM	160	290	48	498	666	1900	2400	14,6	195,0		3	3
NU 232	M	160	290	48	440	591	1900	2400	14,6	195,0		3	3
NU 2232	EM	160	290	80	706	1128	1800	2200	23,3				
NU 2232	M	160	290	80	650	978	1700	2000	24,3	195,0		3	3
NU 332	EM	160	340	68	738	978	1500	1800	30,56				
NU 332	M	160	340	68	702	883	1600	1900	31,7	208,0		4	4
NU 2332	EM	160	340	114	1128	1689	1500	1800	50,98				
NU 2332	M	160	340	114	1069	1522	1600	1900	53,2	208,0		4	4
NUP 232	EM	160	290	48	498	666	1900	2400	14,6	195,0		3	3
NUP 232	M	160	290	48	440	591	1900	2400	14,6	195,0		3	3
NUP 2232	M	160	290	80	650	978	1700	2000	24,3	195,0		3	3
NUP 332	M	160	340	68	702	883	1600	1900	32	208,0		4	4
N 234	EM	170	310	52	618	828	1800	2200	17,6		272,0	4	4
N 2234	M	170	310	86	748	1141	1700	2000	29,8		272,0	4	4

Single Row Cylindrical Roller Bearings

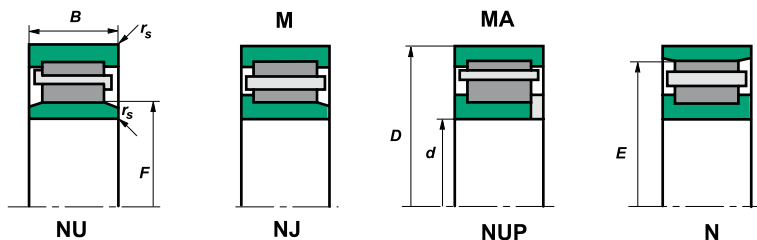

Bearing		ISO dimensions			Load ratings		Speed limits		Weight kg	Dimensions			
Type	Version	d mm	D	B	C kN	Co kN	Grease r/min	Oil r/min		F	E	r _s min	r _{1s} min
N 334	EM	170	360	72	809	1040	1400	1700	38,45				
NJ 1034	M	170	260	42	277	400	2200	2800	8,36	193,0		2,1	2,1
NJ 234	EM	170	310	52	520,4	747,8	1800	2200	17,96				
NJ 234	M	170	310	52	499	677	1800	2200	18,2	208,0		4	4
NJ 2234	EM	170	310	86	820	1340	1800	2200	30,1				
NJ 334	EM	170	360	72	928	1149	1500	1800	38	215,0		4	4
NJ 334	M	170	360	72	801	1018	1500	1800	38	220,0		4	4
NJ 2334	EM	170	360	10	1310	2030	1400	1700	62,28				
NJ 2334	M	170	360	120	1226	1758	1400	1700	62,7	220,0		4	4
NU 1034	M	170	260	42	277	400	2200	2800	7,9	193,0		2,1	2,1
NU 234	EM	170	310	52	618	828	1800	2200	17,6	207,0		4	4
NU 234	M	170	310	52	499	677	1800	2200	18,1	208,0		4	4
NU 2234	EM	170	310	86	914	1316	1700	2000	28,57	205,0		4	4
NU 2234	M	170	310	86	748	1141	1700	2000	29,8	208,0		4	4
NU 334	EM	170	360	72	809	1040	1400	1700	38,5				
NU 334	M	170	360	72	801	1018	1500	1800	38	220,0		4	4
NU 2334	EM	170	360	120	1310	2030	1400	1700	61,3				
NU 2334	M	170	360	120	1226	1758	1400	1700	62,7	220,0		4	4
NUP 234	M	170	310	52	499	677	1800	2200	18,2	208,0		4	4
NUP 2234	EM	170	310	86	914	1316	1700	2000	29,8	205,0		4	4
NUP 2234	M	170	310	86	748	1141	1700	2000	29,8	208,0		4	4
NUP 334		170	360	72	801	1018	1600	1900	38	220,0		4	4
N 1036	M	180	280	46	337	479	2000	2600	10,9	255,0		2,1	2,1
N 236	EM	180	320	52	541,4	797,2	1700	2000	18,17				



Bearing		ISO dimensions			Load ratings		Speed limits		Weight kg	Dimensions			
Type	Version	d mm	D	B	C kN	Co kN	Grease r/min	Oil r/min		F	E	r _s min	r _{1s} min
N 236	M	180	320	52	516	717	1800	2200	18,8		218,0	4	4
N 336	M	180	380	75	903	1155	1500	1800	43,4		328,0	4	4
NJ 1036	M	180	280	46	336	260	2000	2600	10,9	205,0		2,1	2,1
NJ 236	EM	180	320	52	541,4	797,2	1700	2000	18,45				
NJ 236	M	180	320	52	516	717	1800	2200	18,7	218,0		4	4
NJ 2236	E	180	320	86	955	1408	1600	1900	31,1	215,0		4	4
NJ 2236	EM	180	320	86	955	1408	1600	1900	31,1	215,0		4	4
NJ 2236	M	180	320	86	775	1208	1600	1900	31,1	218,0		4	4
NJ 336	M	180	380	75	903	1155	1500	1800	43,4	232,0		4	4
NU 1036	M	180	280	46	336	479	2000	2600	10,9	205,0		2,1	2,1
NU 236	EM	180	320	52	541,4	797,2	1700	2000	18,16				
NU 236	M	180	320	52	516	717	1800	2200	18,8	218,0		4	4
NU 2236	EM	180	320	86	955	1408	1600	1900	30,5	215,0		4	4
NU 2236	M	180	320	86	775	1208	1600	1900	31,1	218,0		4	4
NU 336	EM	180	380	75	913	1180	1500	1800	42,5				
NU 336	M	180	380	75	903	1155	1500	1800	43,4	232,0		4	4
NU 2336	EM	180	380	126	1400	2040	1300	1600	73				
NU 2336	M	180	380	126	1380	1995	1300	1600	73,9	232,0		4	4
NUP 236	M	180	320	52	516	717	1800	2200	18,8	218,0		4	4
NUP 2236	EM	180	320	86	955	1408	1600	1900	31,1	215,0		4	4
NUP 2236	M	180	320	86	775	1208	1600	1900	31,1	218,0		4	4
NUP 336	M	180	380	75	903	1155	1500	1800	43,4	232,0		4	4
N 238	EM	190	340	55	600,8	846,6	1600	1900	21,74				
N 238	M	190	340	55	567	790	1700	2000	22,5		299,0	4	4

Single Row Cylindrical Roller Bearings

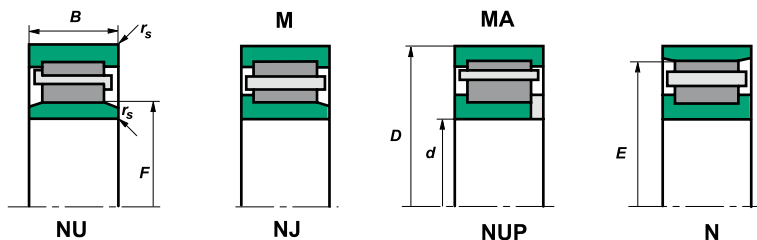

Bearing		ISO dimensions			Load ratings		Speed limits		Weight kg	Dimensions			
Type	Version	d mm	D	B	C kN	Co kN	Grease r/min	Oil r/min		F	E	r _s min	r _{1s} min
NJ 1038	M	190	290	46	357	525	1900	2200	11,4	215,0		2,1	2,1
NJ 1938	M.	190	260	33	251	400	1800	2340	5,5	209,0		1	2
NJ 238	EM	190	340	55	600,8	846,6	1600	1900	21,89				
NJ 238	M	190	340	55	567	790	1700	2000	22,7	231,0		4	4
NJ 2238	M	190	340	92	854	1338	1500	1800	37,8	231,0		4	4
NJ 338	M	190	400	78	1036	1329	1400	1700	50,5	243,0		5	5
NU 1038		190	290	46	357	525	1900	2200	11,4	215,0		2,1	2,1
NU 1038	M	190	290	46	357	525	1900	2200	11,4	215,0		2,1	2,1
NU 238	EM	190	340	55	651	878	1700	2000	22,5	230,0		4	4
NU 238	EM	190	340	55	651	878	1700	2000	22,5	230,0		4	4
NU 238	M	190	340	55	567	790	1700	2000	22,7	231,0		4	4
NU 2238	EM	190	340	92	1100	1660	1600	1900	39	231,0		4	4
NU 2238	M	190	340	92	854	1338	1500	1800	36,74	231,0		4	4
NU 338	EM	190	400	78	1150	1489	1400	1700	50,5	245,0		5	5
NU 338	M	190	400	78	1036	1329	1400	1700	50,5	243,0		5	5
NU 2338	EM	190	400	132	1789	2628	1300	1600	85,5	245,0		5	5
NUP 238	M	190	340	55	567	790	1700	2000	23,1	231,0		4	4
N 240	EM	200	360	58	663	996	1500	1800	26,56				
N 240	M	200	360	58	634	892	1600	1900	26,5		316,0	4	4
N 340	EM	200	420	80	1250	1678	1300	1600	56,2		368,0	5	5
NJ 1040	M	200	310	51	395	590	2000	2600	14,8	229,0		2,1	2,1
NJ 240	EM	200	360	58	720	979	1600	1900	26,9	243,0		4	4
NJ 240	M	200	360	58	634	892	1600	1900	26,9	244,0		4	4
NJ 2240	EM	200	360	98	1220	1860	1400	1700	45,5	241,0		4	4



Bearing		ISO dimensions			Load ratings		Speed limits		Weight kg	Dimensions			
Type	Version	d mm	D	B	C kN	Co kN	Grease r/min	Oil r/min		F	E	r _s min	r _{1s} min
NJ 340	EM	200	420	80	1250	1648	1300	1600	57,1	260,0		5	5
NJ 340	M	200	420	80	974	1273	1300	1600	57,1	260,0		5	5
NU 1040	M	200	310	51	395	590	2000	2600	14,8	229,0		2,1	2,1
NU 1940	EM	200	280	38	264	405	2200	2800	7,4	221,0		2,1	2,1
NJ 1940	MA	200	280	38	264	405	2200	2800	7,4	221		2,1	2,1
NU 240	EM	200	360	58	663	996	1500	1800	26,42				
NU 240	M	200	360	58	634	892	1600	1900	26,5	244,0		4	4
NU 2240	EM	200	360	98	1220	1860	1400	1700	45,5	241,0		4	4
NU 2240	M	200	360	98	1220	1860	1400	1700	45,5			4	4
NU 340	EM	200	420	80	1250	1648	1300	1600	56	260,0		5	5
NU 340	M	200	420	80	974	1273	1300	1600	57,1	260,0		5	5
NU 2340	EM	200	420	138	1740	2685	1200	1500	97			5	5
NU 2340	M	200	420	138	1740	2685	1200	1500	97	260,0		5	5
NUP 1040	M	200	310	51	395	590	2000	2600	14,8	229,0		2,1	2,1
NUP 240	M	200	360	58	634	892	1600	1900	27,5	244,0		4	4
N 244	EM	220	400	65	725	1110	1500	1800	36,45				
N 244	M	220	400	65	778	1113	1400	1700	38,5		350,0	4	4
N 344	EM	220	460	88	1130	1160	1200	1500	72,21				
NJ 1044	M	220	340	56	650	1047	1300	1600	19,3	250,0		3	3
NJ 244	EM	220	400	65	725	1110	1500	1800	37,1				
NJ 244	M	220	400	65	778	1113	1400	1700	38,1	270,0		4	4
NJ 344	EM	220	460	88	1130	1160	1200	1500	72,72				
NJ 2344	M	220	460	145	2425	3750	1400	1700	125			5	5
NU 1044	M	220	340	56	650	1047	1300	1600	18,5	250,0		3	3

Single Row Cylindrical Roller Bearings

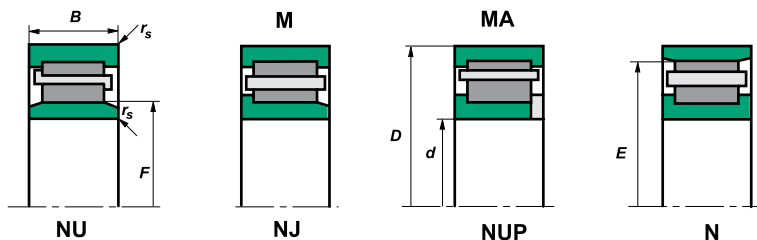

Bearing		ISO dimensions			Load ratings		Speed limits		Weight kg	Dimensions			
Type	Version	d mm	D	B	C kN	Co kN	Grease r/min	Oil r/min		F	E	r _s min	r _{1s} min
NU 244	EM	220	400	65	725	1110	1500	1800	36,4				
NU 244	M	220	400	65	778	1113	1400	1700	38	270,0		4	4
NU 2244	EM	220	400	108	1570	2280	1300	1600	62,5				
NU 2244	M	220	400	108	1370	2310	1400	1700	61,5	270,0		4	4
NU 344	EM	220	460	88	1130	1160	1200	1500	72,34				
NU 2344	EM	220	460	145	2425	3750	1400	1700	125			5	5
NU 2344	M	220	460	145	2425	3750	1400	1700	125			5	5
NUP 244	M	220	400	65	778	113	1400	1700	40,2	270,0		4	4
NUP 2244	M	220	400	108	1370	2310	1400	1700	61,5			4	4
NUP 2344	M	220	460	145	2425	3750	1400	1700				5	5
NJ 1944	M	220	300	38	336	560	2400	3000	8,3	250,0		2,1	2,1
NU 1948	M	240	320	38	308	540	1900	2400	8,5	260,0		2,5	1,8
NU 1048	M	240	360	56	520	820	1700	2000	20	270,0		3	3
NJ 1048	M	240	360	56	512	775	1700	2000	21,1	270,0		3	3
NU 248	M	240	440	72	1050	1540	1300	1600	46,9	295,0		4	4
NJ 248	M	240	440	72	1050	1540	1300	1600	49,6	295,0		4	4
NU 2248	M	240	440	120	1490	2450	1200	1500	84,8	295,0		4	4
N 348	M	240	500	95	1530	2120	1000	1300	96,3		430,0	5	5
NU 348	M	240	500	95	1530	2120	1000	1300	96,3	310,0		5	5
NU 2348	M	240	500	155	2190	3360	950	1200	155	310,0		5	5
NU 1052	M	260	400	65	688	1090	1500	1800	30,2	347,0		4	4
NUP 1052	M	260	400	65	688	1090	1500	1800	37,2	296,0		4	4
NJ 1052	M	260	400	65	688	1090	1500	1800	36,3	296,0		4	4
NU 2052	EM	260	400	82	1080	1880	1300	1700	40,1	294,0		4	4



Bearing		ISO dimensions			Load ratings		Speed limits		Weight kg	Dimensions			
Type	Version	d mm	D	B	C kN	Co kN	Grease r/min	Oil r/min		F	E	r _s min	r _{s15} min
NU 3052	M	260	400	104	1350	2340	1150	1450	49,5	290,5		4	4
NU 3152	M	260	440	144	2050	3450	950	1250	98	298,5		4	4
NU 252	M	260	480	80	1220	1800	1100	1400	67,1	320,0		5	5
NJ 252	M	260	480	80	1220	1800	1050	1350	68,5	320,0		5	5
NUP 252	M	260	480	80	1220	1800	1050	1350	70	320,0		5	5
NU 2252		260	480	130	1780	2910	1000	1300	106	320,0		5	5
NU 2252	M	260	480	130	1780	2910	1000	1300	107	320,0		5	5
N 2252	M	260	480	130	1780	2910	950	1250	105		420,0	5	5
NJ 2252	M	260	480	130	1780	2910	950	1250	108	320,0		5	5
NU 352	M	260	540	102	1880	2750	850	1050	126	337,0		6	6
NU 2352	M	260	540	165	3150	4500	850	1050	188	319,0		6	6
NJ 2856	M	280	350	42	363	790	1800	2200	9,15	299,0		2	2
NU 1956	M	280	380	46	473	865	1700	1900	15,5	306,0		2,1	2,1
NU 1056	M	280	420	65	704	1140	1400	1700	30,9	316,0		4	4
NJ 1056	M	280	420	65	704	1140	1400	1700	32,2	316,0		4	4
NU 2056	M	280	420	82	1190	2170	1050	1300	39,5	314,0		4	4
NU 3156	M	280	460	146	2250	3900	900	1150	106	321,0		5	5
NJ 256	M	280	500	80	1100	1750	1150	1450	71,5	340,0		5	5
NU 256	M	280	500	80	1100	1750	1150	1450	70	340,0		5	5
NU 356	M	280	580	108	1880	2660	850	1000	147	362,0		6	6
NU 2356	M	280	580	175	2560	4250	900	1100	232	362,0		6	6
NU 2256	EM	280	500	130									
NJ 2860	M	300	380	48	450	1000	1370	1650	15,5	321,0		2,1	2,1
NU 2860	M	300	380	48	450	1000	1370	1650	14,5	321,0		2,1	2,1

Single Row Cylindrical Roller Bearings

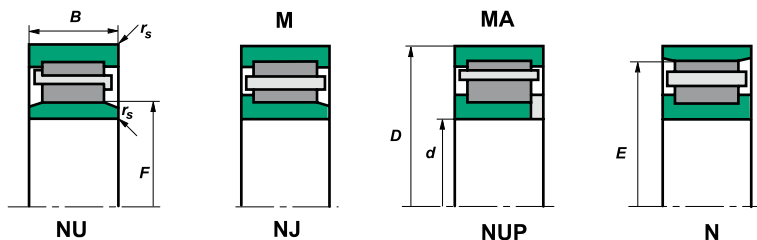

Bearing		ISO dimensions			Load ratings		Speed limits		Weight kg	Dimensions			
Type	Version	d mm	D	B	C kN	Co kN	Grease r/min	Oil r/min		F	E	r _s min	r _{1s} min
NJ 1060	M	300	460	74	935	1510	1200	1500	45,1	340,0		4	4
NU 1060	M	300	460	74	935	1510	1200	1500	44,1	340,0		4	4
NU 2060	M	300	460	95	1470	2800	980	1250	60	341,0		4	4
NU 3060	M	300	460	118	1470	2700	1200	1500	72,5	340,0		4	4
NU 260	M	300	540	85	1510	2270	1000	1300	86,9	364,0		5	5
NU 2260	M	300	540	140	2080	3450	1000	1200	146	364,0		5	5
NU 360	M	300	620	109	2310	3300	900	1100	166	385,0		7,5	7,5
NU 2360	M	300	620	185	3860	5850	830	1000	271	371,0		7,5	7,5
NU 1864	M	320	400	38	365	715	1270	1550	11,3	341,0		2,1	1,5
NU 2864	M	320	400	48	490	1050	1250	1550	15	341,0		2,1	1,5
NU 1964	M	320	440	56	638	1130	1100	1400	24,7	350,0		3	3
NJ 1064	M	320	480	74	957	1580	1100	1400	47,8	360,0		4	4
NU 1064	M	320	480	74	957	1580	1100	1400	48,2	360,0		4	4
NUP 1064	M	320	480	74	957	1580	1100	1400	49,1	360,0		4	4
NU 2064	M	320	480	95	1380	2650	970	1250	63	360,0		4	4
NU 3064	M	320	480	121	1540	2910	1100	1400	78,1	360,0		4	4
NU 3164	M	320	540	176	3050	5450	870	1050	176	368,0		5	5
NU 264	M	320	580	92	1530	2450	960	1200	116	390,0		5	5
NU 2264		320	580	150	2480	4150	900	1100	181	390,0		5	5
NJ 2868	M	340	420	48	490	1150	1150	1450	15,5	361,0		2,1	2,1
NU 1968	M	340	460	56	700	1400	1050	1350	28,3	370,0		3	3
NU 2968	M	340	460	72	785	1650	1050	1350	36,2	373,0		3	3
NU 1068	M	340	520	82	1160	1910	1000	1300	65	385,0		5	5
NU 2268	M	340	620	165	2600	4550	810	950	225	416,0		6	6



Bearing		ISO dimensions			Load ratings		Speed limits		Weight kg	Dimensions			
Type	Version	d mm	D	B	C kN	Co kN	Grease r/min	Oil r/min		F	E	r _s min	r _{1s} min
NU 1072	M	360	540	82	1080	2000	980	1280	65,9	405,0		5	5
NU 2072	M	360	540	106	1890	3560	870	1050	89,5	405,0		5	5
NU 3072	M	360	540	134	2060	4050	800	1000	112	405,0		5	5
NU 3172		360	600	192	3520	6500	900	1000	219	420,0		5	5
NU 2272	M	360	650	170	3150	5400	800	950	262	437,0		6	6
NU 2372		360	750	224	5390	8650	700	850	480	455,0		7,5	7,5
NU 1876	M	380	480	46	525	1050	950	1250	23,5	406,0		2,1	2,1
NUP 1876	M	380	480	46	525	1050	950	1250	24	406,0		2,1	2,1
NU 1076	M	380	560	82	1220	2090	950	1200	71	425,0		5	5
NU 2076	EM	380	560	106	1930	3750	800	950	93	425,0		5	5
NU 3076	EM	380	560	135	2250	4700	800	950	116	425,0		5	5
NU 2276	EM	380	680	175	3050	5500	730	860	276	462,0		6	6
NU 1880	M	400	500	46	565	1150	980	1250	21,2	423,0		2,1	2,1
NU 1980	M	400	540	65	900	1750	900	1150	42	435,0		4	4
NU 2980	EM	400	540	82	1350	2850	900	1150	57,8	435,0		4	4
NU 2980	M	400	540	82	1250	2510	900	1150	55,2	438,0		4	4
NJ 4980	M	400	540	140	5170	2220	1200	1500	84			3	3
NUP 1080	M	400	600	90	1330	2210	900	1100	93,6	450,0		5	5
NU 1080	M	400	600	90	1330	2210	900	1100	92,5	450,0		5	5
NJ 1080		400	600	90	1440	2470	900	1100	90,6	450,0		5	5
NU 2080	EM	400	600	118	2150	4800	750	900	122	449,0		5	5
NU 3080	M	400	600	148	2330	4550	900	1100	153	450,0		5	5
NU 2180	M	400	650	145	2920	5190	700	850	197	460,0		6	6
NU 3180	M	400	650	200	3760	7170	700	850	274	460,0		6	6

Single Row Cylindrical Roller Bearings

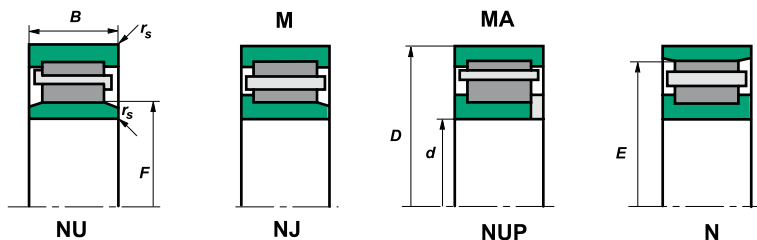

Bearing		ISO dimensions			Load ratings		Speed limits		Weight kg	Dimensions			
Type	Version	d mm	D	B	C kN	Co kN	Grease r/min	Oil r/min		F	E	r _s min	r _{1s} min
NU 1884		420	520	46	605	1270	900	1100	20,7	447,0		2,1	2,1
NJ 3884	M	420	520	75	900	2250	930	1150	33,3	447,0		2,1	2,1
NJ 1984	M	420	560	65	1080	1950	930	1150	46	449,0		4	4
NU 2984	M	420	560	82	1180	2600	930	1150	59,5	458,0		4	4
NU 1084	M	420	620	90	1440	2490	900	1100	98	470,0		5	5
NU 2084	EM	420	620	118	2400	4750	770	950	127	469,0		5	5
NU 3184	EM	420	700	224	4950	8950	650	780	368	485,0		6	6
NU 2888	EM	440	540	60	790	1900	870	1050	34,5	464,0		2,1	2,1
NU 1988	M	440	600	74	1010	1980	870	1050	65	482,0		4	4
NJ 2988	EM	440	600	95	1670	3550	870	1050	83,5	481,5		4	4
NUP 3988	EM	440	600	118	1940	4250	850	1000	106	481,5		4	4
NU 1088	M	440	650	94	1570	2430	850	1000	102	493,0		6	6
NU 2088	EM	440	650	122	2450	5000	670	820	146	487,0		6	6
N 1188		440	720	122	2850	4300	800	950	207		648,0	6	6
NU 3188		440	720	226	5230	9800	600	750	374	508,0		6	6
N 1892	M	460	580	56	795	1720	800	950	37,2		553,0	3	3
NJ 2892	EM	460	580	72	1030	2350	860	1050	48,7	489,0		3	3
NJ 2992		460	620	95	1640	3500	800	950	83,4	502,0		4	4
NUP 2992		460	620	95	1670	1600	800	950	85	502,0		4	4
NU 2992		460	620	95	1670	1600	800	950	98,3	502,0		4	4
NU 1092	M	460	680	100	1690	2630	800	950	111	516,0		6	6
NU 2092	EM	460	680	128	2700	5450	650	800	166	513,0		6	6
NU 3092	M	460	680	163	2970	6150	650	790	211	516,0		6	6
NU 3092	EM	460	680	163	3300	6340	650	790	211	499,0		6	6



Bearing		ISO dimensions			Load ratings		Speed limits		Weight kg	Dimensions			
Type	Version	d mm	D	B	C kN	Co kN	Grease r/min	Oil r/min		F	E	r _s min	r _{1s} min
NU 3192		460	760	240	5450	10400	400	480	467	531,0		7,5	7,5
NU 3192	M	460	760	240	5450	10400	400	480	481	531,0		7,5	7,5
NU 1292		460	830	165	4200	6800	600	720	405	554,0		7,5	7,5
NU 2292	M	460	830	212	4850	8000	580	670	515	554,0		7,5	7,5
NU 1896	M	480	600	56	750	1620	840	950	37,5	511,0		3	3
NJ 2896	EM	480	600	72	1050	2400	840	950	46,5	509,5		3	3
NU 1096	M	480	700	100	1600	2970	720	860	128	536,0		6	6
NU 2096	M	480	700	128	2600	5250	600	720	176	536,0		6	6
NU 3196	EM	480	790	248	5650	10700	500	600	495	547,0		7,5	7,5
NU 28/500	EM	500	620	72	1130	2670	780	940	48,5	530,0		3	3
NU 19/500	EM	500	670	78	1160	2350	720	880	80	544,0		5	5
NU 29/500		500	670	100	1940	4300	750	900	101	543,0		5	5
N 39/500	EM	500	670	128	2250	5150	670	840	128		633,0	5	5
NJ 10/500		500	720	100	1680	3050	720	880	136	556,0		6	6
NU 20/500	EM	500	720	128	2850	5900	620	720	175	553,0		6	6
NU 30/500		500	720	167	3210	6970	620	720	232	556,0		6	6
NU 31/500		500	830	264	6250	12200	480	580	602	581,0		7,5	7,5
NU 12/500	M	500	920	185	5050	8450	540	650	585	603,1		7,5	7,5
NU 60/500	M	500	720	100	2270	4270	750	900	136,9	555,0		6	6
NJ 19/530	EM	530	710	82	1500	2980	680	830	94,5	573,0		5	5
NUP 29/530		530	710	106	1990	4550	400	500	125	580,0		5	5
NU 10/530	M	530	780	112	2200	4050	650	780	187	593,0		6	6
NU 20/530	EM	530	780	145	3650	7360	550	650	252	591,0		6	6
NU 31/530	EM	530	870	272	7250	14500	460	550	663	612,0		7,5	7,5

Single Row Cylindrical Roller Bearings

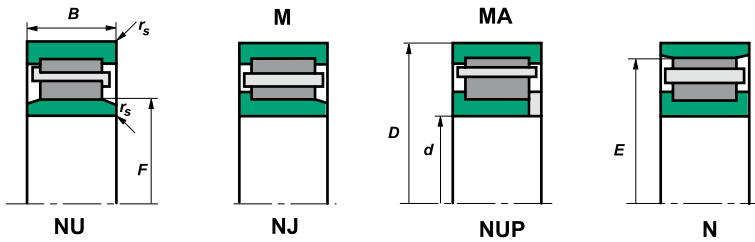

Bearing		ISO dimensions			Load ratings		Speed limits		Weight kg	Dimensions			
Type	Version	d mm	D	B	C kN	Co kN	Grease r/min	Oil r/min		F	E	r _s min	r _{1s} min
NJ 18/560	M	560	680	56	810	1830	670	820	42,5	591,0		3	3
NU 19/560	EM	560	750	85	1630	3200	650	780	108	608,0		5	5
NJ 29/560		560	750	112	2420	5450	650	780	153	607,0		5	5
N 29/560		560	750	112	2490	5600	650	780	138		703,0	5	5
NU 10/560	M	560	820	115	2250	4200	620	720	215	625,0		6	6
NU 20/560	EM	560	820	150	3650	7600	500	600	289	626,0		6	6
NU 12/560	M	560	1030	206	6850	11000	460	550	809	668,0		9,5	9,5
NU 18/600	EM	600	730	60	860	2000	650	780	49,3	632,0		3	3
NU 28/600	EM	600	730	78	1250	3350	620	730	68,5	632,0		3	3
NU 19/600	EM	600	800	90	1900	3800	620	750	128	649,0		5	5
NUP 19/600	EM	600	800	90	1900	3800	620	750	135	649,0		5	5
NU 10/600		600	870	118	2840	5250	590	680	234	667,0		6	6
NU 20/600	EM	600	870	155	4180	8000	500	600	320	661,0		6	6
NUP 19/600	M	600	800	90	1900	3800	630	750	140	649		5	5
NUP 29/600	M	600	800	118	2920	6550	630	750	145	649		5	5
NJ 18/630	EM	630	780	69	1050	2500	630	750	74,2	667,0		4	4
N 28/630	M	630	780	88	1800	4500	630	750	95,6		744,0	4	4
NU 28/630	M	630	780	88	1800	4500	630	750	96	668,0		4	4
N 38/630	M	630	780	112	2150	5750	550	650	118		745,0	4	4
NU 19/630	M	630	850	100	1980	4000	600	700	158	688,0		6	6
NJ 19/630		630	850	100	1980	4000	600	700	167	688,0		6	6
NU 19/630	EM	630	850	100	2150	4250	600	700	160	683,0		6	6
NU 29/630	EM	630	850	128	3250	7250	580	680	214	683,0		6	6
NJ 29/630	EM	630	850	128	3250	7250	580	680	222	683,0		6	6



Bearing		ISO dimensions			Load ratings		Speed limits		Weight kg	Dimensions			
Type	Version	d mm	D	B	C kN	Co kN	Grease r/min	Oil r/min		F	E	r _s min	r _{1s} min
NU 10/630	EM	630	920	128	3400	6250	450	530	284	702,0		7,5	7,5
NUP 10/630	EM	630	920	128	3400	6250	450	530	284	702,0		7,5	7,5
NU 20/630	EM	630	920	170	4700	9500	480	560	395	699,0		7,5	7,5
NU 30/630		630	920	212	6450	14500	450	530	485	699,0		7,5	7,5
NJ 18/670		670	820	69	1230	2800	550	650	83,8	708,0		4	4
NUP 19/670		670	900	103	2420	4900	530	630	193	731,0		6	6
NU 19/670		670	900	103	2420	4900	530	630	193	731,0		6	6
NU 10/670	M	670	980	136	3700	6800	430	500	344	747,0	914,0	7,5	7,5
N 30/670		670	980	230	6930	15000	430	500	594	744,0		7,5	7,5
NU 30/670		670	980	230	6500	14500	430	500	596	744,0		7,5	7,5
NU 6/700		700	930	160	3520	8500	500	600	306	760,0		6	6
NUP 6/700		700	930	160	3520	8500	500	600	316	760,0		6	6
N 28/710		EM	710	870	95	1880	4950	480	560	128		831,0	4
NU 19/710	EM	710	950	106	2590	5500	480	560	210	770,0		6	6
NU 29/710		710	950	140	3650	8250	480	560	294	766,0		6	6
NU 10/710		710	1030	140	4550	8400	420	490	420	778,0		7,5	7,5
NU 20/710	EM	710	1030	185	5800	12000	420	490	535	787,0		7,5	7,5
NU 18/750	M	750	920	78	1450	3500	480	590	105	794,0		5	5
N 28/750		750	920	100	2160	5500	480	590	145		880,0	5	5
NU 10/750	EM	750	1090	150	4500	8500	350	415	492	830,0		7,5	7,5
NU 20/750	EM	750	1090	195	6700	14500	350	415	634	832,0		7,5	7,5
NJ 18/800	EM	800	980	82	1700	4200	430	510	144	846,0		5	5
NU 10/800	EM	800	1150	155	5400	10500	320	380	565	883,0		7,5	7,5
NU 20/800	EM	800	1150	200	6900	14500	320	380	710	882,0		7,5	7,5

Single Row Cylindrical Roller Bearings

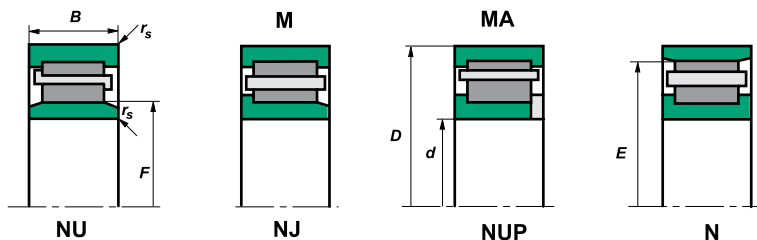

Bearing		ISO dimensions			Load ratings		Speed limits		Weight kg	Dimensions			
Type	Version	d mm	D	B	C kN	Co kN	Grease r/min	Oil r/min		F	E	r _s min	r _{1s} min
N 6/820		820	990	72	1180	2960	450	530	128	943,0	5	5	
NU 28/850	M	850	1030	106	2050	5900	410	480	192	902,0	5	5	
NU 19/850	EM	850	1120	118	3050	6900	390	460	325	919,0	6	6	
NJ 19/850		850	1120	118	2930	7000	390	460	326	919,0	6	6	
N 29/850	EM	850	1120	155	4500	11300	390	460	428	1059,0	6	6	
NU 18/900	M	900	1090	85	1900	4850	370	440	172	949,0	5	5	
NU 28/900	M	900	1090	112	2650	7150	370	440	234	949,0	5	5	
NU 19/900	EM	900	1180	122	4050	8700	350	420	378	966,5	6	6	
NU 29/900	EM	900	1180	165	5750	13500	350	420	565	969,0	6	6	
NU 29/950		950	1250	175	5560	13000	340	400	596	1024,0	7,5	7,5	
NUP 29/950		950	1250	175	5670	13400	140	170	616	1024,0	7,5	7,5	
NU 18/1000	M	1000	1220	100	2650	6550	350	420	264	1053,0	6	6	
NJ 28/1000	EM	1000	1220	128	3600	9500	350	420	345	1053,0	6	6	
N 28/1060	M	1060	1280	128	3550	10500	310	370	355	1225,0	6	6	
NU 29/1060	EM	1060	1400	195	7200	17000	290	350	875	1146,0	7,5	7,5	
NU 39/1060	EM	1060	1400	250	9000	23500	250	310	1060	1146,0	7,5	7,5	
N 30/1060		1060	1500	325	12500	32500	230	290	1880	1390,0	9,5	9,5	
NJ 18/1120	EM	1120	1360	106	3350	8600	270	330	330	1182,0	6	6	
NJ 18/1180	EM	1180	1420	106	2950	7750	250	320	354	1242,0	6	6	
NU 29/1180	M	1180	1540	206	8950	21500	180	220	1100	1258,0	7,5	7,5	
NU 29/1180	EM	1180	1540	206	8950	21500	180	220	1100	1258,0	7,5	7,5	
N 39/1180	M	1180	1540	272	11000	28500	190	250	1350	1466,0	7,5	7,5	
N 20/1250	M	1250	1750	290	12500	29500	165	190	2310	1635,0	9,5	9,5	
NU 18/1320	M	1320	1600	122	3650	9500	190	250	525	1395,0	6	6	



Bearing		ISO dimensions			Load ratings		Speed limits		Weight kg	Dimensions			
Type	Version	d mm	D	B	C kN	Co kN	Grease r/min	Oil r/min		F	E	r _s min	r _{1s} min
NU 19/1320		1320	1720	175	7920	19500	190	240	1110	1425,0		7,5	7,5
N 39/1320	M	1320	1720	300	12600	32500	175	210	1890		1640,0	7,5	7,5
N 28/1400	EM	1400	1700	175	6300	1750	175	210	858		1637,0	7,5	7,5
NU 18/1700	EM	1700	2060	160	6950	18500	125	155	1156	1784,0		7,5	7,5
N 18/1900		1900	2300	175	8150	23700	90	115	1480		2204,0	9,5	9,5



Double Rows Cylindrical Roller Bearings

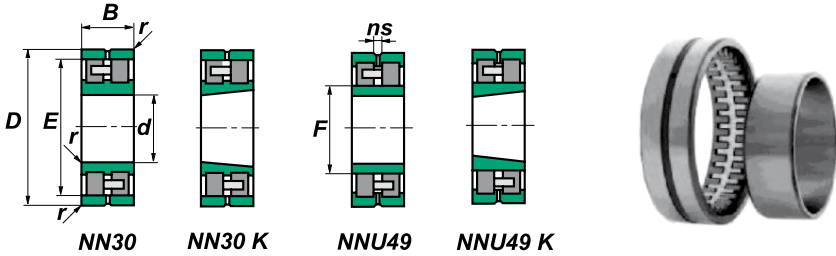

Bearing		ISO dimensions			Load ratings		Speed limits		Weight kg	Dimensions			
Type	Version	d mm	D	B	C kN	Co kN	Grease r/min	Oil r/min		F	E	rs min	ns
NN 3006	K M NA	30	55	19	29,0	38	11000	14000	0,192		48,5	1,0	4,5
NN 3007	K M NA	35	62	20	36,5	47	10000	12000	0,246		55,0	1,0	4,5
NN 3008	K M NA	40	68	21	42,5	58	9000	11000	0,298		61,0	1,0	4,5
NN 3009	K M NA	45	75	23	48,5	70	8000	9500	0,382		67,5	1,0	4,5
NN 3010	K M NA	50	80	23	51,5	80	7500	9000	0,415		72,5	1,0	4,5
NN 3011	K M NA	55	90	26	69,0	100	6700	8000	0,618		81,0	1,1	4,5
NN 3012	K M NA	60	95	26	72,0	110	6300	7500	0,664		86,1	1,1	4,5
NN 3013	K M NA	65	100	26	74,0	118	6000	7000	0,705		91,0	1,1	4,5
NN 3014	K M NA	70	110	30	96,0	151	5300	6300	1,020		100,0	1,1	6,5
NN 3015	K M NA	75	115	30	96,0	153	5000	6000	1,080		105,0	1,1	6,5
NN 3016	K M NA	80	125	34	118,0	184	4800	5600	1,500		113,0	1,1	6,5
NN 3017	K M NA	85	130	34	122,0	200	4500	5300	1,580		118,0	1,1	6,5
NN 3018	K M NA	90	140	37	141,0	224	4300	5000	2,010		127,0	1,5	6,5
NN 3019	K M NA	95	145	37	146,0	236	4000	4800	2,100		132,0	1,5	6,5
NN 3020	K M NA	100	150	37	152,0	264	3800	4500	2,210		137,0	1,5	6,5
NNU 4920	M NA	100	140	40	125,0	244	4000	4800	1,790	113,0		1,1	6,5
NNU 4920	K M NA	100	140	40	125,0	244	4000	4800	1,800	113,0		2,0	
NN 3021	K M NA	105	160	41	192,0	310	3600	4300	2,810		146,0	2,0	6,5
NNU 4921	K M NA	105	145	40	118,0	231	3800	4500	2,000	118,0		1,1	
NN 3022	K M NA	110	170	45	226,0	365	3400	4000	3,560		155,0	2,0	6,5
NNU 4922	K M NA	110	150	40	129,0	264	3800	4500	1,910	123,0		1,1	6,5
NN 3024	K M NA	120	180	46	235,0	405	3200	3800	3,870		165,0	2,0	6,5
NNU 4924	K M NA	120	165	45	170,0	328	3400	4000	2,660	134,0		1,1	6,5
NN 3026	K M NA	130	200	52	294,0	510	3000	3600	5,760		182,0	2,0	9,5

Bearing		ISO dimensions			Load ratings		Speed limits		Weight kg	Dimensions			
Type	Version	d mm	D	B	C kN	Co kN	Grease r/min	Oil r/min		F	E	rs min	ns
NNU 4926	K M NA	130	180	50	193,0	371	3200	3800	3,600	146,0		1,5	6,5
NN 3028	K M NA	140	210	53	305,0	520	2800	3400	6,210		192,0	2,0	9,5
NNU 4928	K M NA	140	190	50	189,0	395	3000	3600	3,790	156,0		1,5	6,5
NN 3030	K M NA	150	225	56	339,0	600	2600	3000	7,500		206,0	2,1	9,5
NNU 4930	K M NA	150	210	60	326,0	645	2600	3200	6,460	168,5		2,0	
NNU 4932	K M NA	160	220	60	322,0	652	2600	3000	6,380	178,0		2,0	
NN 3034	K M NA	170	260	67	458,0	810	2200	2600	12,400		236,0	2,1	9,5
NNU 4934	K M NA	170	230	60	335,0	718	2400	3000	7,210	188,5		2,0	6,5
NN 3036	K M NA	180	280	74	576,0	1080	2000	2600	16,300		255,0	2,1	12,2
NNU 4952	K M NA	260	360	100	745,0	1780	1600	1900	31,000	292,0		2,1	
NN 3048	K	240	360	92	885,0	1690	1700	2000	32,700		330,0	3,0	
NN 3056	K M NA	280	420	106	1110	1985	1400	1700	49,5		384	4,0	15,0
NNU 4960	K M NA	300	420	118	1075	2410	1300	1600	50,5	339		3,0	
NNU 4960	K M NA	300	420	118	1075	2410	1300	1600	50,5	339		3,0	
NNU 4164	M	320	540	218	3300	6200	700	1000	200,0	375		5,0	
NNU 4964	K M NA	320	440	118	1115	2581	1300	1500	54,5	359		3,0	
NNU 4172	M	360	600	243	3900	8500	900	1100	275			3,0	
NNU 4972	M	360	480	118	1120	2800	1120	1400	55,0	399		3,0	3,0
NN 3076	K M NA	380	560	135	1640	3650	1000	1200	111,0		513	5,0	16,7
NNU 4976	K M NA	380	520	140	1485	3760	1100	1300	91,0	426		4,0	
NNU 4976	K M NA	380	520	140	1485	3760	1100	1300	91,0	426		4,0	
NNU 4992	K M NA	460	620	160	2135	5543	900	1100	143,0	510		4,0	
NNU 49/500	K M NA	500	670	170	2715	6920	800	1000	178,0	552		5,0	
NNU 49/530	K M NA	530	710	180	3140	8845	800	950	218,0	588		5,0	
NNU 49/630	K M NA	630	850	218	3835	10716	670	800	368,0	704		6,0	

Full Complement Cylindrical Roller Bearings

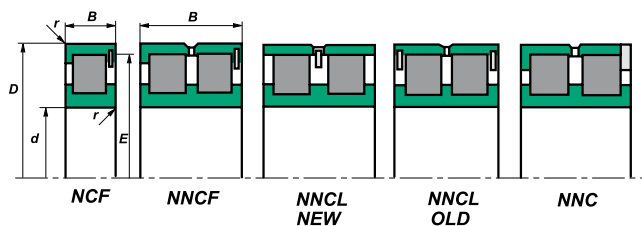

Bearing Type	ISO dimensions	Load ratings		Speed limits		Weight kg	Dimensions					
		d	D mm	B	C kN		Co kN	Grease r/min	Oil r/min	E	r _s min	r _{is} min
NCF 2920	CV	100	140	24	132	224	1000	2200	1,15		1,1	1
NCF 3020	V	100	150	37	240	375	950	2000	2,32	139	1,5	1,5
NCF 3024	CV	120	180	46	341	550	800	1700	3,95		2	1
NCF 3024	V	120	180	46	340	550	800	1700	3,96	167,5	2	2
NCF 2926	CV	130	180	30	205	360	750	1600	2,3		1,5	1,1
NCF 3026	V	130	200	52	420	690	700	1500	5,44	185,5	2	2
NCF 2928	CV	140	190	30	220	390	700	1500	2,4		1,5	1,1
NCF 3028	V	140	210	53	460	750	670	1400	6,3	196,5	2	2
NCF 2930	V	150	210	36	280	500	670	1400	3,86	196	2	2
NCF 3030	V	150	225	56	500	850	630	1300	7,78	208	2,1	2,1
NCF 2932	CV	160	220	36	297	540	630	1300	4,05		2	1,1
NCF 2932	V	160	220	36	295	540	630	1300	4,11	240,7	2	2
NCF 3032	V	160	240	60	580	950	600	1200	9,1	225,1	2,1	2,1
NCF 2934	CV	170	230	36	308	570	600	1200	4,25		2	1,1
NCF 2934	V	170	230	36	300	570	600	1200	4,28	216	2	2
NCF 3034	V	170	260	67	730	1180	560	1100	12,5	243,2	2,1	2,1
NCF 2936	CV	180	250	42	391	695	560	1100	6,25		2	1,1
NCF 2936	V	180	250	42	410	690	560	1100	6,15	231	2	2
NCF 3036	V	180	280	74	820	1370	560	1100	16,7	260	2,1	2,1
NCF 2938	V	190	260	42	420	750	560	1100	6,43	242,5	2	2
NCF 3038	V	190	290	75	850	1400	530	1000	17,7	267,5	2,1	2,1
NCF 1840	V	200	250	24	180	330	560	1100	2,57	237,8	1,5	1,5
NCF 2940	CV	200	280	48	528	965	530	1000	9,15		2,1	1,5
NCF 2940	V	200	280	48	500	1000	530	1000	9,01	261,2	2,1	2,1

Bearing Type	ISO dimensions			Load ratings		Speed limits		Weight kg	Dimensions			
	d	D mm	B	C kN	C ₀ kN	Grease r/min	Oil r/min		E	r _s min	r _{1s} min	
NCF 3040	CV	200	310	82	990	1700	500	950	22,5		2,1	2,1
NCF 3040	V	200	310	82	990	1700	500	950	22,6	286	2,1	2,1
NCF 1844	V	220	270	24	190	360	530	1000	2,8	257,5	1,5	1,5
NCF 2944	V	220	300	48	500	1000	480	900	9,6	282	2,1	2,1
NCF 3044	CV	220	340	90	1190	2040	450	850	29,5		3	3
NCF 3044	V	220	340	90	1190	2040	450	850	30,2	312	3	3
NCF 1848	V	240	300	28	260	500	480	900	4,4	284	2	2
NCF 2948	CV	240	320	48	583	1140	450	850	11		2,1	1,5
NCF 2948	V	240	320	48	580	1140	450	850	10,3	303	2,1	2,1
NCF 3048	CV	240	360	92	1250	2240	430	800	32		3	3
NCF 3048	V	240	360	92	1150	2240	430	800	32,7	335,6	3	3
NCF 1852	V	260	320	28	270	550	430	800	4,71	307	2	2
NCF 2952	V	260	360	60	730	1430	400	750	18,4	333,7	2,1	1,5
NCF 3052	V	260	400	104	1610	2850	380	700	46,5	373,5	4	4
NCF 1856	V	280	350	33	330	650	400	750	7	332	2	2
NCF 2956	V	280	380	60	890	1700	380	700	19,6	362,7	2,1	2,1
NCF 3056	V	280	420	106	1680	3050	360	670	50	391,5	4	4
NCF 1860	V	300	380	38	400	800	360	670	10	359	2,1	2,1
NNCF 4860	V	300	380	80	792	2120	380	700	23		2,1	
NCF 2960	CV	300	420	72	1120	2200	340	630	31,5		3	3
NCF 2960	V	300	420	72	1120	2200	340	630	30,5	390	3	3
NCF 3060	V	300	460	118	2090	3750	320	600	69	432	4	4
NCF 1864	V	320	400	38	400	800	340	630	10,6	377	2,1	2,1
NCF 2964	CV	320	440	72	1140	2360	320	600	33		3	3



Full Complement Cylindrical Roller Bearings

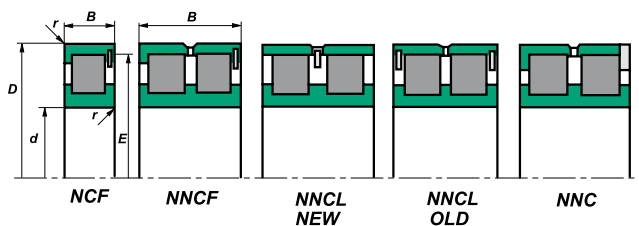

Bearing Type	ISO dimensions			Load ratings		Speed limits		Weight kg	Dimensions			
		d	D mm	B	C kN	C ₀ kN	Grease r/min		Oil r/min	E	r _s min	r _{is} min
NCF 2964	V	320	440	72	1140	2300	320	600	32,3	410	3	3
NCF 3064	V	320	480	121	2120	3900	300	560	74,5	447,3	4	4
NCF 1868	V	340	420	38	410	840	320	600	11,2	401	2,1	2,1
NCF 2968	V	340	460	72	1100	2500	300	560	34,5	432	3	3
NCF 3068	V	340	520	133	2240	4250	280	530	100	486	5	5
NCF 1872	V	360	440	38	420	900	300	560	11,7	419	2,1	2,1
NCF 2972	CV	360	480	72	1230	2600	280	530	36,5		3	3
NCF 2972	V	360	480	72	1250	2650	280	530	36	450,5	3	3
NCF 3072	V	360	540	134	2640	4900	260	500	105	503,2	5	5
NCF 1876	V	380	480	46	600	1200	280	530	19,2	456	2,1	2,1
NCF 2976	CV	380	520	82	1570	3250	260	500	52,5		4	4
NCF 2976	V	380	520	82	1570	3250	260	500	52,1	487	4	4
NCF 3076	V	380	560	135	2700	5100	240	480	110	520,5	5	5
NCF 1880	V	400	500	46	620	1300	260	500	19,2	472	2,1	2,1
NCF 2980	CV	400	540	82	1650	3450	240	480	54,5		4	4
NCF 2980	V	400	540	82	1500	3300	240	480	52,1	511	4	4
NCF 3080	V	400	600	148	3190	6100	220	450	145	559,1	5	5
NCF 1884	V	420	520	46	640	1380	240	480	20,9	496	2,1	2,1
NCF 2984	V	420	560	82	1750	3600	200	430	55,8	524	4	4
NCF 3084	V	420	620	150	3300	6300	200	430	150	578,2	5	5
NCF 1888	V	440	540	46	640	1380	220	450	22	519	2,1	2,1
NCF 2988	V	440	600	95	2100	4100	200	430	78	565,5	4	4
NCF 3088	V	440	650	157	3740	7350	190	400	175	607,5	6	6
NCF 1892	V	460	580	56	800	1700	200	430	33,9	553	3	3

Bearing Type	ISO dimensions			Load ratings		Speed limits		Weight kg	Dimensions			
	d	D mm	B	C kN	Co kN	Grease r/min	Oil r/min		E	r _s min	r _{1s} min	
NCF 2992	V	460	620	95	2150	4300	190	400	80,8	579	4	4
NCF 3092	V	460	680	163	4130	8000	180	380	195	635	6	6
NCF 1896	V	480	600	56	935	2040	190	400	35,5	573,5	3	3
NCF 2896	V	480	600	72	1320	3150	190	400	46	573,5	3	3
NCF 2996	V	480	650	100	2290	5100	180	380	94,7	606	5	5
NCF 3096	V	480	700	165	4180	8300	170	360	205	655,2	6	6
NCF 18/500	V	500	620	56	952	2120	180	380	35,5	594	3	3
NCF 28/500	V	500	620	72	1340	3350	180	380	48	594	3	3
NCF 29/500	V	500	670	100	2380	5300	170	360	100	634,5	5	5
NCF 30/500	V	500	720	167	4290	8650	170	360	215	676,8	6	6
NCF 18/530	V	530	650	56	990	2240	170	360	37,5	624,5	3	3
NCF 28/530	V	530	650	72	1400	3450	170	360	49,5	624,5	3	3
NCF 29/530	V	530	710	106	2700	6000	160	340	120	673	5	5
NCF 30/530	V	530	780	185	5230	10600	150	320	300	732,3	6	6
NCF 18/560	V	560	680	56	1020	2360	150	320	40,5	655	3	3
NCF 28/560	V	560	680	72	1420	3650	160	340	54	651,5	3	3
NCF 29/560	V	560	750	112	3030	6700	150	320	140	709	5	5
NCF 30/560	V	560	820	195	5830	11800	140	300	345	770	6	6
NCF 18/600	V	600	730	60	1050	2550	150	320	49,5	696	3	3
NCF 29/600	V	600	800	118	3360	7500	140	300	170	754	5	5
NCF 18/630	V	630	780	69	1250	2900	140	300	70	739	4	4
NCF 29/630	V	630	850	128	3740	8650	130	280	205	807	6	6
NCF 18/670	V	670	820	69	1300	3150	130	280	74	783	4	4
NCF 28/670	V	670	820	88	1910	5190	130	280	96,6	783	4	4



Full Complement Cylindrical Roller Bearings

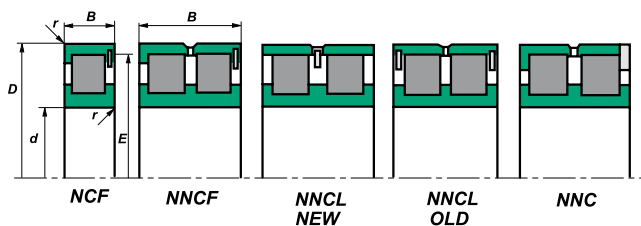

Bearing Type	ISO dimensions			Load ratings		Speed limits		Weight kg	Dimensions			
	d	D mm	B	C kN	C ₀ kN	Grease r/min	Oil r/min		E	r _s min	r _{is} min	
NCF 29/670	V	670	900	136	3800	8650	120	260	245	846	6	6
NCF 29/710	V	710	950	140	3910	9150	110	240	275	896	6	6
NCF 18/750	V	750	920	78	1760	4300	110	240	110	880	5	5
NCF 28/750	V	750	920	100	2510	6800	110	240	140	880	5	5
NCF 29/750	V	750	1000	145	4460	10600	100	220	315	938	6	6
NCF 18/800	V	800	980	82	1940	4800	100	220	130	936	5	5
NCF 28/800	V	800	980	106	2750	7500	100	220	165	936	5	5
NCF 29/800	V	800	1060	150	4950	12200	95	200	360	1002	6	6
NCF 29/850	V	850	1120	155	5280	12900	90	190	405	1061	6	6
NCF 29/900	V	900	1180	165	5940	14600	80	170	472	1120	6	6
NCF 29/950	V	950	1250	175	6660	16300	75	160	565	1179	7,5	7,5
NCF 29/1000	V	1000	1320	185	7480	18600	70	150	680	1252	7,5	7,5
NCF 18/1120	V	1120	1360	106	9960	3720	130	175	366	-	6	6
NCF 18/1400	V	1400	1700	132	15320	5350	90	125	740	-	7,5	7,5





SPHERICAL ROLLER BEARINGS

Dimensions in accordance with ISO 15-2008

Spherical roller bearings are designed to sustain heavy loads, shaft misalignment and deflection. They contain two symmetrical or asymmetrical rows of barrel-shaped rollers, which align themselves in the outer race sphered track. They are, therefore, able to carry very heavy radial loads and axial loads in either direction.

Roller guidance is achieved by the fixed flanges on the inner ring for the CA, GMEX, MB, VS and MA - design or a floating ring for the C design. For further information, see roller guidance design on next page.

Misalignment

The table below gives figures for permitted misalignment in the different bearing series.

Bearings series	Angular misalignment degrees
213	1°
222	1.5°
223	2°
230	1.5°
231	1.5°
232	2.5°
239	1.5°
240	2°
241	2.5°



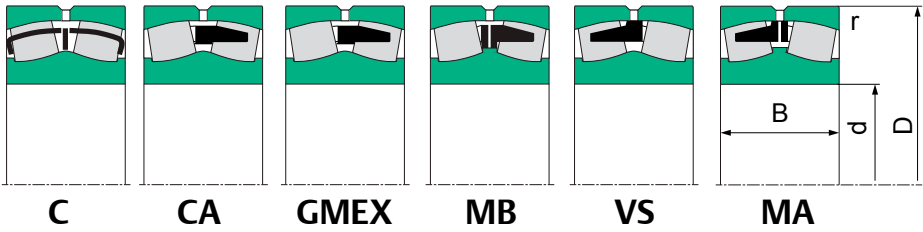

Roller Guidance Designs

The sketches above show six types of roller guidance.

- C : 2 pressed sheet steel cages, rollers guided on a floating ring
- CA : 1 piece brass cage, roller guided between 2 inner ring flanges. Cage is guided on the rollers. Assymetrical roller position.
- GMEX : 1 piece brass cage, roller guided between 2 inner ring flanges. Cage is guided on the rollers. Assymetrical roller position.
- MB : 2 piece brass cage, roller guided between 2 inner ring flanges and one central rib. Cage is guided on the inner ring.
- VS C4 F80 : 1 piece brass cage, roller guided between 2 inner ring flanges. Cage is guided on the outer ring.
- MA C4 F80 : 2 piece brass cage, roller guided between 2 inner ring flanges and one central rib. Cage is guided on the outer ring.

Spherical roller bearings are manufactured with tapered bore-K(1:12) and K30 (1:30) with lubrication groove and 3 lubrication holes on the outside diameter W33. All Rollway sphericals have the W33 feature.

Tolerances

Spherical roller bearings with cylindrical and tapered bore are generally manufactured to “PO” precision class.

Radial Clearance

Spherical roller bearings with cylindrical and tapered bore are generally manufactured to normal (CN), C2, C3, C4 and C5 clearances.

Heat Treatment

Spherical roller bearings with outside diameter $D > 240\text{mm}$ of all series given in this catalog can be used to an operating temperature of $+150^{\circ}\text{C}$ ($+302^{\circ}\text{F}$). Small size bearings operate normally at temperatures up to $+120^{\circ}\text{C}$ ($+248^{\circ}\text{F}$).

Spherical Roller Bearings

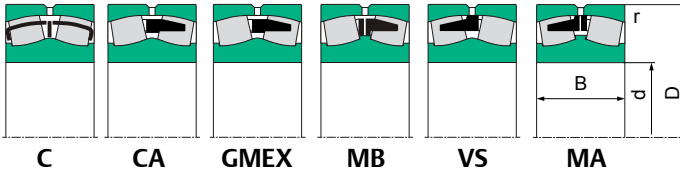

Bearing		Principal Dimensions			Basic Load Ratings		Speed Ratings		Radius (Mm) R _{smin}	Weight (Kg) G	Calculation Factors			
Type	Cage	Bore (Mm) D	Outer (Mm) D	Width (Mm) B	Dynamic (Kn) C _r	Static (Kn) C _{or}	Grease (Rpm)	Oil (Rpm)			E	Y ₁	Y ₂	Y _o
22205	GMEX	25	52	18	38.9	37.0	11050	14450	0.2	1.00	0.35	1.95	2.90	1.91
22206	GMEX	30	62	20	55.7	57.0	8500	11900	0.3	1.00	0.33	2.03	3.02	1.98
21307	GMEX	35	80	21	70.0	75.0	5695	8075	0.5	1.50	0.27	2.53	3.77	2.47
22207	GMEX	35	72	23	76.7	80.0	7650	10200	0.4	1.10	0.34	2.00	2.98	1.96
21308	GMEX	40	90	23	96.1	94.4	5950	8075	0.7	1.50	0.27	2.51	3.74	2.45
22208	GMEX	40	80	23	84.0	89.6	6800	9350	0.5	1.10	0.29	2.35	3.50	2.30
22308	GMEX	40	90	33	128.1	136.0	5100	6800	1.0	1.50	0.39	1.75	2.61	1.71
22308	VS C4 F80	40	90	33	125.0	135.0	5300	6300	1.5	1.05	0.39	1.80	2.60	1.70
21309	GMEX	45	100	25	120.8	120.0	5355	7225	1.0	1.50	0.27	2.51	3.74	2.45
22209	GMEX	45	85	23	90.0	100.0	6375	8500	0.6	1.10	0.26	2.57	3.82	2.51
22309	GMEX	45	100	36	153.5	168.2	4505	5950	1.4	1.50	0.38	1.77	2.64	1.73
22309	VS C4 F80	45	100	36	153.0	179.0	4800	5800	1.5	1.41	0.37	1.80	2.70	1.80
21310	GMEX	50	110	27	124.0	139.0	4760	6370	1.3	2.00	0.25	2.67	3.97	2.61
22210	GMEX	50	90	23	91.1	104.0	5950	8075	0.6	1.10	0.24	2.77	4.12	2.70
22310	GMEX	50	110	40	202.7	224.0	4080	5355	1.9	2.00	0.37	1.84	2.74	1.80
22310	VS C4 F80	50	110	40	193.0	226.0	4600	5600	2.0	1.91	0.37	1.80	2.70	1.80
21311	GMEX	55	120	29	142.0	152.0	4760	6375	1.6	2.00	0.25	2.74	4.08	2.68
22211	GMEX	55	100	25	119.7	138.0	5355	7225	0.9	1.50	0.24	2.79	4.15	2.73
22311	GMEX	55	120	43	226.8	252.0	3655	4760	2.4	2.00	0.37	1.80	2.69	1.76
22311	VS C4 F80	55	120	43	226.0	268.0	4000	4800	2.0	2.37	0.36	1.90	2.80	1.80
23111	MB	55	120	43	220.0	255.0	2800	3600	2.0	2.43	0.25	2.70	4.02	2.70
21312	GMEX	60	130	31	178.5	190.0	4080	5355	2.1	2.10	0.24	2.76	4.11	2.70
22212	GMEX	60	110	28	133.4	154.0	4760	6375	1.2	1.50	0.24	2.78	4.13	2.71
22312	GMEX	60	130	46	316	316.0	3400	4500	2.1	2.93	0.37	1.85	2.75	1.76
22312	VS C4 F80	60	130	46	262.0	313.0	3800	4400	2.1	2.94	0.36	1.90	2.80	1.80
21313	GMEX	65	140	33	203.7	214.0	3655	5100	2.5	2.10	0.24	2.85	4.25	2.79
22213	GMEX	65	120	31	176.4	205.0	4250	5950	1.6	1.50	0.25	2.69	4.00	2.63
22313	GMEX	65	140	48	304.5	345.0	3230	4250	3.6	2.10	0.35	1.95	2.90	1.91
22313	VS C4 F80	65	140	48	285.0	330.0	3600	4200	2.1	3.67	0.35	1.90	2.90	1.90
21314	GMEX	70	150	35	224.7	240.0	3400	4760	3.0	2.10	0.23	2.88	4.29	2.82



Spherical Roller Bearings

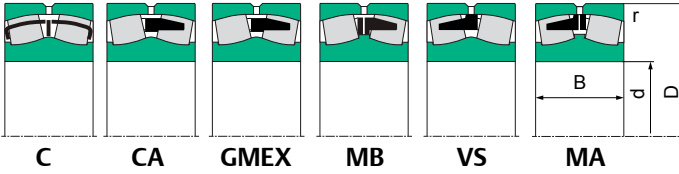

Bearing		Principal Dimensions			Basic Load Ratings		Speed Ratings		Radius (Mm) R _{smin}	Weight (Kg) G	Calculation Factors			
Type	Cage	Bore (Mm) D	Outer (Mm) D	Width (Mm) B	Dynamic (Kn) C _r	Static (Kn) C _{or}	Grease (Rpm)	Oil (Rpm)			E	Y ₁	Y ₂	Y _o
22214	GMEX	70	125	31	181.7	215.0	4250	5695	1.7	1.50	0.23	2.90	4.31	2.83
22314	GMEX	70	150	51	353.9	417.0	2890	3825	4.4	2.10	0.34	1.99	2.96	1.94
22314	VS C4 F80	70	150	51	340.0	420.0	3600	4000	2.1	4.39	0.34	2.00	2.90	1.90
21315	GMEX	75	160	37	263.6	283.0	3400	4760	3.6	2.10	0.23	2.90	4.31	2.83
22215	GMEX	75	130	31	186.9	227.0	4080	5355	1.7	1.50	0.22	3.04	4.53	2.97
22315	GMEX	75	160	55	374.9	447.0	723	1020	5.5	2.10	0.38	1.78	2.65	1.74
22315	VS C4 F80	75	160	55	380.0	475.0	3000	3600	2.1	5.35	0.35	2.00	2.90	1.90
21316	GMEX	80	170	39	285.6	310.0	3230	4505	4.3	2.10	0.23	2.92	4.35	2.86
22216	GMEX	80	140	33	201.6	244.0	3655	5100	2.1	2.00	0.22	3.07	4.57	3.00
22316	GMEX	80	170	58	453.2	535.0	2550	3400	6.6	2.10	0.35	1.92	2.86	1.88
22316	VS C4 F80	80	170	58	420.0	535.0	2800	3400	2.1	6.41	0.34	2.00	2.90	1.90
21317	GMEX	85	180	41	309.0	356.0	3230	4505	5.1	3.00	0.23	2.96	4.41	2.90
22217	GMEX	85	150	36	247.8	308.0	3400	4760	2.7	2.00	0.22	3.01	4.48	2.94
22317	GMEX	85	180	60	478.8	543.0	2380	3230	3	7.14	0.34	1.99	2.96	1.94
22317	VS C4 F80	85	180	60	462.0	591.0	2500	3200	3.0	7.47	0.34	2.00	3.00	2.00
22317	MB	85	180	60	460.0	570.0	1700	2200	3.0	7.25	0.38	1.78	2.64	1.80
22318	CA	90	190	64	472.0	600.0	1900	2500	3.0	8.87	0.35	1.92	2.86	1.88
23218	CA	90	160	52.4	316.0	453.0	1600	2200	2.0	4.64	0.33	2.07	3.09	2.03
21318	GMEX	90	190	43	360.2	397.0	3060	4080	5.9	3.00	0.23	2.97	4.42	2.90
22218	GMEX	90	160	40	294.0	369.0	3230	4505	3.5	2.00	0.24	2.87	4.27	2.80
23218	GMEX	90	160	52	354.9	483.0	2380	3230	4.4	3.00	0.31	2.16	3.22	2.11
22318	VS C4 F80	90	190	64	530.0	677.0	2600	3000	3.0	8.56	0.34	2.00	3.00	2.00
23218	MB	90	160	52	340.0	485.0	1500	2000	2.0	4.60	0.34	1.99	2.96	2.00
22318	MB	90	190	64	530.0	670.0	1700	2200	3.0	8.69	0.38	1.78	2.64	1.80
22319	CA	95	200	67	516.0	657.0	1800	2300	3.0	10.40	0.35	1.92	2.86	1.88
21319	GMEX	95	200	45	402.2	460.0	2890	3825	6.9	3.00	0.22	3.04	4.52	2.97
22219	GMEX	95	170	43	329.7	414.0	3060	4080	4.2	2.10	0.24	2.81	4.18	2.75
22319	VS C4 F80	95	200	67	568.0	744.0	2200	2800	3.0	10.31	0.34	2.00	3.00	2.00
22319	MB	95	200	67	570	740	1500	2000	3.0	10.20	0.41	1.65	2.45	1.70
22320	CA	100	215	73	613	799	1600	2200	3.0	13.30	0.35	1.91	2.85	1.87

Bearing		Principal Dimencions			Basic Load Ratings		Speed Ratings		Radius (Mm) R _{smin}	Weight (Kg) G	Calculation Factors			
Type	Cage	Bore (Mm) D	Outer (Mm) D	Width (Mm) B	Dynamic (Kn) C _r	Static (Kn) C _{0r}	Grease (Rpm)	Oil (Rpm)			E	Y ₁	Y ₂	Y ₀
23120	CA	100	165	52	326	490	1700	2200	2.0	4.39	0.31	2.21	3.29	2.16
23220	CA	100	180	60.3	405	589	1500	1900	2.1	6.81	0.33	2.03	3.02	1.98
24020	CA	100	150	50	242	425	1500	2000	1.5	3.15	0.30	2.23	3.32	2.18
21320	GMEX	100	215	47	429	498	2890	3825	8.4	3.00	0.22	3.06	4.56	2.99
22220	GMEX	100	180	46	379	475	2890	3825	5.1	2.10	0.24	2.80	4.18	2.74
22320	VS C4 F80	100	215	73	670.0	880.0	2200	2600	3.0	13.21	0.34	2.00	2.90	1.90
23120	MB	100	165	52	355	540	2000	2600	2.0	4.50	0.33	2.05	3.05	2.10
23220	MB	100	180	60	455	660	1500	2000	2.1	6.70	0.34	1.99	2.96	2.00
22320	MB	100	215	73	670	880	1400	1800	3.0	12.70	0.41	1.65	2.45	1.70
22222	CA	110	200	53	414	574	2000	2700	2.1	7.69	0.26	2.55	3.80	2.50
22322	CA	110	240	80	724	915	1500	2000	3.0	18.30	0.35	1.91	2.85	1.87
23022	CA	110	170	45	304	489	1900	2500	2.0	3.79	0.25	2.67	3.97	2.61
23122	CA	110	180	56	382	596	1500	2000	2.0	5.72	0.29	2.32	3.45	2.26
23222	CA	110	200	69.8	528	786	1300	1800	2.1	9.79	0.34	2.00	2.97	1.95
24022	CA	110	170	60	294	506	1300	1800	2.0	5.60	0.32	2.12	3.15	2.07
24122	CA	110	180	69	462	758	1200	1500	2.0	6.85	0.37	1.84	2.74	1.80
22322	VS C4 F80	110	240	80	800.0	1060.0	1800	2200	3.0	18.01	0.35	2.00	2.90	1.90
23022	MB	110	170	45	295	485	2000	2600	2.0	3.75	0.26	2.60	3.87	2.60
23024	MB	110	180	46	335	560	1800	2400	2.0	4.20	0.24	2.81	4.19	2.80
23122	MB	110	180	56	410	640	1800	2400	2.0	5.55	0.31	2.18	3.24	2.20
23222	MB	110	200	70	570	840	1200	1600	2.1	9.70	0.34	1.99	2.96	2.00
21322	MB	110	240	50	510	690	1500	2000	3.0	12.00	0.21	3.21	4.79	3.20
22322	MB	110	240	80	800	1060	1300	1700	3.0	17.70	0.38	1.78	2.64	1.80
22224	CA	120	215	58	488	666	1900	2500	2.1	9.06	0.27	2.49	3.71	2.43
22324	CA	120	260	86	848	1130	1400	1800	3.0	23.40	0.34	1.96	2.92	1.92
23024	CA	120	180	46	317	514	1700	2300	2.0	4.10	0.24	2.79	4.15	2.73
23124	CA	120	200	62	468	726	1400	1900	2.0	8.01	0.30	2.25	3.34	2.20
23224	CA	120	215	76	592	904	1200	1600	2.1	12.10	0.34	1.98	2.94	1.93
24024	CA	120	180	60	386	673	1200	1700	2.0	5.40	0.31	2.18	3.24	2.13
24124	CA	120	200	80	601	994	1100	1400	2.0	10.20	0.39	1.74	2.59	1.70



Spherical Roller Bearings

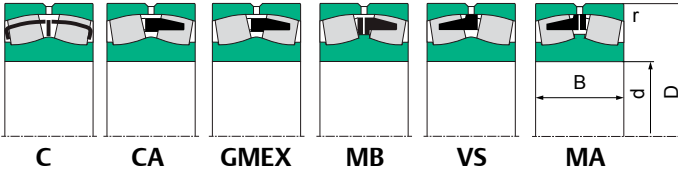

Bearing		Principal Dimensions			Basic Load Ratings		Speed Ratings		Radius (Mm) R _{smin}	Weight (Kg) G	Calculation Factors			
Type	Cage	Bore (Mm) D	Outer (Mm) D	Width (Mm) B	Dynamic (Kn) C _r	Static (Kn) C _{or}	Grease (Rpm)	Oil (Rpm)			E	Y ₁	Y ₂	Y _o
22324	VS C4 F80	120	260	86	930.0	1230.0	1700	2000	3.0	22.49	0.34	2.00	3.00	2.00
24024	MB	120	180	60	410	740	1460	1800	2.0	5.12	0.34	1.99	2.96	2.00
23124	MB	120	200	62	495	770	1700	2200	2.0	7.80	0.31	2.18	3.24	2.20
22224	MB	120	215	58	510	740	1500	2000	2.1	9.04	0.30	2.25	3.35	2.30
24124	MB	120	200	80	630	1050	1000	1300	2.0	10.20	0.43	1.57	2.34	1.60
23224	MB	120	215	76	670	1020	1100	1500	2.1	12.00	0.38	1.78	2.64	1.80
22324	MB	120	260	86	930	1230	1100	1500	3.0	22.00	0.38	1.78	2.64	1.80
22226	CA	130	230	64	613	880	1800	2300	3.0	11.20	0.28	2.43	3.61	2.37
22326	CA	130	280	93	978	1320	1300	1700	4.0	28.50	0.35	1.95	2.90	1.91
23026	CA	130	200	52	401	660	1600	2100	2.0	6.02	0.25	2.71	4.04	2.65
23126	CA	130	210	64	512	798	1300	1800	2.0	8.75	0.28	2.40	3.58	2.35
23226	CA	130	230	80	670	1020	1100	1500	3.0	14.30	0.34	1.99	2.96	1.94
24026	CA	130	200	69	484	841	1100	1500	2.0	8.16	0.33	2.07	3.09	2.03
24126	CA	130	210	80	597	1020	980	1300	2.0	11.10	0.36	1.87	2.79	1.83
22326	VS C4 F80	130	280	93	1080	1465	1600	1900	4.0	27.63	0.33	2.00	3.00	2.00
23026	MB	130	200	52	410	670	1700	2200	2.0	6.10	0.24	2.81	4.19	2.80
24026	MB	130	200	69	530	900	1200	1600	2.0	7.95	0.36	1.88	2.79	1.90
23126	MB	130	210	64	540	860	1500	2000	2.0	8.55	0.31	2.18	3.24	2.20
24126	MB	130	210	80	650	1100	900	1200	2.0	11.00	0.41	1.65	2.45	1.70
22226	MB	130	230	64	600	865	1500	2000	3.0	11.20	0.31	2.18	3.24	2.20
23226	MB	130	230	80	760	1170	1100	1500	3.0	14.00	0.34	1.99	2.96	2.00
22326	MB	130	280	93	1080	1450	1100	1400	4.0	28.50	0.38	1.78	2.64	1.80
22228	CA	140	250	68	656	920	1600	2200	3.0	14.30	0.27	2.49	3.71	2.43
22328	CA	140	300	102	1140	1550	1200	1600	4.0	35.90	0.35	1.91	2.85	1.87
23028	CA	140	210	53	415	689	1500	2000	2.0	6.43	0.24	2.81	4.19	2.75
23128	CA	140	225	68	546	876	1200	1600	2.1	10.70	0.28	2.39	3.56	2.34
23228	CA	140	250	88	818	1230	1000	1400	3.0	18.90	0.35	1.92	2.85	1.87
24028	CA	140	210	69	495	865	1100	1400	2.0	8.42	0.31	2.21	3.29	2.16
24128	CA	140	225	85	634	1100	920	1200	2.1	13.10	0.35	1.94	2.88	1.89
22328	VS C4 F80	140	300	102	1240	1720	1400	1500	4.0	35.92	0.35	2.00	2.90	1.90

Bearing		Principal Dimencions			Basic Load Ratings		Speed Ratings		Radius (Mm) R _{smin}	Weight (Kg) G	Calculation Factors			
Type	Cage	Bore (Mm) D	Outer (Mm) D	Width (Mm) B	Dynamic (Kn) C _r	Static (Kn) C _{0r}	Grease (Rpm)	Oil (Rpm)			E	Y ₁	Y ₂	Y ₀
23080	MB	140	210	53	435	750	1500	2000	2.0	6.55	0.24	2.81	4.19	2.80
23128	MB	140	225	68	600	990	1400	1800	2.1	10.20	0.31	2.18	3.24	2.20
23128	MB	140	225	69	600	990	1400	1800	2.1	10.50	0.31	2.18	3.24	2.20
24128	MB	140	225	85	740	1280	850	1100	2.1	13.20	0.38	1.78	2.64	1.80
22228	MB	140	250	68	670	990	1300	1700	3.0	14.00	0.30	2.25	3.35	2.30
23228	MB	140	250	68	880	1380	1000	1300	3.0	18.50	0.38	1.78	2.64	1.80
22328	MB	140	300	102	1240	1720	1000	1300	4.0	34.50	0.41	1.65	2.45	1.70
22230	CA	150	270	73	750	1060	1500	2000	3.0	18.10	0.27	2.49	3.71	2.43
22330	CA	150	320	108	1270	1750	1100	1500	4.0	43.70	0.35	1.92	2.86	1.88
23030	CA	150	225	56	467	789	1400	1900	2.1	7.81	0.24	2.84	4.23	2.78
23130	CA	150	250	80	716	1150	1100	1500	2.1	16.20	0.31	2.16	3.22	2.12
23230	CA	150	270	96	925	1450	980	1300	3.0	24.30	0.36	1.87	2.79	1.83
24030	CA	150	225	75	564	1010	990	1300	2.1	10.50	0.32	2.12	3.15	2.07
24130	CA	150	250	100	891	1520	840	1100	2.1	19.50	0.39	1.74	2.59	1.70
22330	VS C4 F80	150	320	108	1400	1940	1000	1300	4.0	44.30	0.38	2.00	2.90	1.90
23030	MB	150	225	56	480	830	1400	1800	2.1	7.80	0.24	2.81	4.19	2.80
24030	MB	150	225	75	620	1140	1100	1400	2.1	10.50	0.33	2.05	3.05	2.10
23130	MB	150	250	80	800	1320	1300	1700	2.1	16.30	0.33	2.05	3.05	2.10
22230	MB	150	270	73	810	1190	1200	1600	3.0	18.00	0.30	2.25	3.35	2.30
23230	MB	150	270	96	1030	1610	1000	1300	3.0	24.50	0.41	1.65	2.45	1.70
22330	MB	150	320	108	1400	1940	1000	1300	4.0	43.50	0.41	1.65	2.45	1.70
22232	CA	160	290	80	879	1220	1400	1900	3.0	22.80	0.28	2.43	3.61	2.37
22332	CA	160	340	114	1350	1860	1000	1400	4.0	51.90	0.35	1.91	2.85	1.87
23032	CA	160	240	60	538	917	1300	1700	2.1	9.56	0.24	2.84	4.23	2.78
23132	CA	160	270	86	841	1370	1000	1400	2.1	20.80	0.31	2.16	3.22	2.12
23232	CA	160	290	104	1050	1670	910	1200	3.0	31.70	0.36	1.87	2.79	1.83
24032	CA	160	240	80	655	1180	930	1200	2.1	13.00	0.32	2.12	3.15	2.07
24132	CA	160	270	109	1050	1810	780	1000	2.1	26.10	0.39	1.71	2.54	1.67
23032	MB	160	240	60	560	970	1300	1700	2.1	9.50	0.24	2.81	4.19	2.80
23032	MB	160	240	60	560	970	1300	1700	2.1	9.70	0.24	2.81	4.19	2.80



Spherical Roller Bearings

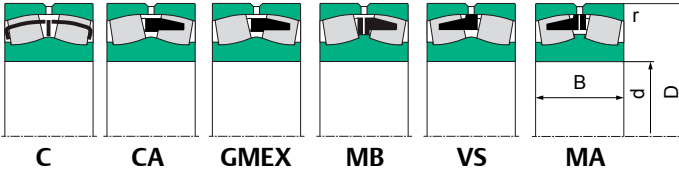

Bearing		Principal Dimensions			Basic Load Ratings		Speed Ratings		Radius (Mm) R _{smin}	Weight (Kg) G	Calculation Factors			
Type	Cage	Bore (Mm) D	Outer (Mm) D	Width (Mm) B	Dynamic (Kn) C _r	Static (Kn) C _{0r}	Grease (Rpm)	Oil (Rpm)			E	Y ₁	Y ₂	Y ₀
24032	MB	160	240	80	720	1320	1000	1300	2.1	13.00	0.34	1.99	2.96	2.00
24032	MB	160	240	80	720	1320	1000	1300	2.1	13.30	0.34	1.99	2.96	2.00
23132	MB	160	270	86	930	1510	1200	1600	2.1	20.50	0.33	2.05	3.05	2.10
22232	MB	160	290	80	950	1420	1100	1500	3.0	23.30	0.30	2.25	3.35	2.30
23232	MB	160	290	104	1180	1830	900	1200	3.0	31.70	0.41	1.65	2.45	1.70
22332	MA C4 F80	160	340	114	1520	2160	900	1200	4.0	50.50	0.38	1.78	2.64	1.80
22332	MB	160	340	114	1520	2160	900	1200	4.0	50.80	0.38	1.78	2.64	1.80
22234	CA	170	310	86	983	1380	1300	1800	4.0	29.20	0.28	2.41	3.59	2.35
22334	CA	170	360	120	1500	2090	980	1300	4.0	61.10	0.35	1.91	2.85	1.87
23034	CA	170	260	67	652	1110	1200	1600	2.1	13.00	0.25	2.74	4.08	2.68
23134	CA	170	280	88	887	1490	990	1300	2.1	22.20	0.31	2.21	3.29	2.16
23234	CA	170	310	110	1230	1970	840	1100	4.0	35.80	0.34	1.99	2.96	1.94
24034	CA	170	260	90	800	1470	860	1200	2.1	17.60	0.33	2.07	3.09	2.03
24134	CA	170	280	109	1080	1870	740	990	2.1	26.40	0.37	1.83	2.72	1.79
23034	MB	170	260	67	680	1170	1200	1600	2.1	13.40	0.24	2.81	4.19	2.80
24034	MB	170	260	90	880	1610	1000	1300	2.1	17.70	0.34	1.99	2.96	2.00
23134	MB	170	280	88	990	1650	1100	1500	2.1	22.30	0.33	2.05	3.05	2.10
22234	MB	170	310	86	1080	1610	1100	1400	4.0	28.90	0.31	2.18	3.24	2.20
23234	MA C4 F80	170	310	110	1340	2120	850	1100	4.0	37.80	0.38	1.78	2.64	1.80
22334	MA C4 F80	170	360	120	1690	2380	850	1100	4.0	60.20	0.38	1.78	2.64	1.80
22334	MB	170	360	120	1690	2380	850	1100	4.0	62.20	0.38	1.78	2.64	1.80
22236	CA	180	320	86	1040	1490	1300	1700	4.0	30.00	0.27	2.51	3.74	2.45
22336	CA	180	380	126	1640	2290	930	1200	4.0	71.40	0.35	1.92	2.86	1.88
23036	CA	180	280	74	702	1170	1100	1500	2.1	17.30	0.24	2.76	4.11	2.70
23136	CA	180	300	96	999	1650	930	1200	3.0	28.00	0.32	2.13	3.17	2.08
23236	CA	180	320	112	1270	2050	820	1100	4.0	39.50	0.35	1.94	2.88	1.89
24036	CA	180	280	100	936	1710	810	1100	2.1	23.50	0.34	1.99	2.96	1.94
24136	CA	180	300	118	1240	2180	700	930	3.0	32.56	0.38	1.77	2.64	1.73
23036	MB	180	280	74	800	1380	1100	1500	2.1	17.60	0.24	2.81	4.19	2.80
23036	MB	180	280	100	1030	1900	900	1200	2.1	23.00	0.36	1.88	2.79	1.90

Bearing		Principal Dimensions			Basic Load Ratings		Speed Ratings		Radius (Mm) R _{smin}	Weight (Kg) G	Calculation Factors			
Type	Cage	Bore (Mm) D	Outer (Mm) D	Width (Mm) B	Dynamic (Kn) C _r	Static (Kn) C _{or}	Grease (Rpm)	Oil (Rpm)			E	Y ₁	Y ₂	Y _o
24036	MB	180	260	100	1030	1900	900	1200	2.1	23.20	0.36	1.88	2.79	1.90
23136	MB	180	300	96	1160	1940	1100	1400	3.0	28.40	0.33	2.05	3.05	2.10
22236	MB	180	320	86	1110	1720	1100	1400	4.0	30.40	0.30	2.25	3.35	2.30
23236	MB	180	320	112	1420	2330	750	1000	4.0	40.80	0.38	1.78	2.64	1.80
22336	MB	180	380	126	1900	2700	850	1100	4.0	68.20	0.38	1.78	2.64	1.80
22336	MA C4 F80	180	380	126	1900	2700	850	1100	4.0	68.20	0.38	1.78	2.64	1.80
22238	CA	190	340	92	1150	1700	1200	1600	4.0	37.30	0.27	2.49	3.71	2.43
22338	CA	190	400	132	1810	2540	880	1200	5.0	82.70	0.35	1.94	2.88	1.89
23038	CA	190	290	75	781	1360	1100	1400	2.1	18.20	0.24	2.76	4.11	2.70
23138	CA	190	320	104	1170	1960	870	1200	3.0	34.90	0.32	2.12	3.15	2.07
23238	CA	190	340	120	1420	2340	760	1000	4.0	48.00	0.33	2.03	3.03	1.99
24038	CA	190	290	100	931	1800	780	1000	2.1	23.80	0.33	2.07	3.09	2.03
24138	CA	190	320	128	1330	2340	650	870	3.0	41.50	0.37	1.82	2.71	1.78
23038	MB	190	290	75	830	1470	1100	1400	2.1	18.60	0.26	2.60	3.87	2.60
24038	MB	190	290	100	1080	1980	850	1100	2.1	24.30	0.34	1.99	2.96	2.00
23138	MB	190	320	104	1320	2290	1100	1400	3.0	35.60	0.34	1.99	2.96	2.00
22238	MB	190	340	92	1220	1870	1000	1300	4.0	37.70	0.30	2.25	3.35	2.30
24138	MB	190	320	128	1540	2750	600	800	3.0	41.80	0.43	1.57	2.34	1.60
23238	MB	190	340	120	1610	2640	750	1000	4.0	48.90	0.38	1.78	2.64	1.80
22338	MB	190	400	132	2060	2920	750	1000	5.0	84.80	0.38	1.78	2.64	1.80
22338	MA C4 F80	190	400	132	1610	2640	750	1000	4.0	48.80	0.36	1.90	2.80	1.80
22240	CA	200	360	98	1290	1910	1100	1500	4.0	43.20	0.27	2.47	3.67	2.41
22340	CA	200	420	138	1990	2800	840	1100	5.0	95.20	0.35	1.95	2.90	1.91
23040	CA	200	310	82	867	1470	1000	1400	2.1	23.30	0.24	2.76	4.11	2.70
23140	CA	200	340	112	1370	2310	830	1100	3.0	43.10	0.32	2.09	3.11	2.04
23240	CA	200	360	128	1580	2620	730	970	4.0	57.80	0.36	1.90	2.83	1.86
24040	CA	200	310	109	1170	2170	730	970	2.1	31.40	0.33	2.03	3.02	1.98
24140	CA	200	340	140	1590	2790	620	830	3.0	53.30	0.40	1.68	2.50	1.64
23940	MB	200	280	60	525	1020	1100	1400	2.1	11.5	0.21	3.14	4.78	3.3
24140	MB	200	340	140	1400	2385	560	750	3.0	51.50	0.43	1.57	2.34	1.60



Spherical Roller Bearings

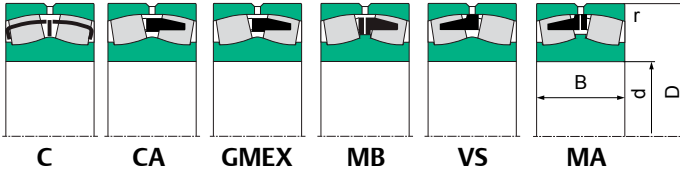

Bearing		Principal Dimensions			Basic Load Ratings		Speed Ratings		Radius (Mm) R _{smin}	Weight (Kg) G	Calculation Factors			
Type	Cage	Bore (Mm) D	Outer (Mm) D	Width (Mm) B	Dynamic (Kn) C _r	Static (Kn) C _{or}	Grease (Rpm)	Oil (Rpm)			E	Y ₁	Y ₂	Y _o
23240	MB	200	360	128	1620	2590	750	1000	4.0	58.50	0.38	1.78	2.64	1.80
22340	MB	200	420	138	1910	2750	670	900	5.0	95.00	0.38	1.78	2.64	1.80
22244	CA	220	400	108	1560	2260	1000	1400	4.0	59.50	0.26	2.55	3.80	2.50
23044	CA	220	340	90	1030	1790	930	1200	3.0	31.00	0.24	2.79	4.15	2.73
23144	CA	220	370	120	1500	2570	760	1000	4.0	54.10	0.31	2.21	3.29	2.16
23244	CA	220	400	144	1960	3270	660	880	4.0	81.50	0.36	1.87	2.79	1.83
24044	CA	220	340	118	1370	2550	660	880	3.0	40.50	0.33	2.07	3.09	2.03
24144	CA	220	370	150	1870	3390	570	750	4.0	67.50	0.39	1.71	2.54	1.67
22344	CA	220	460	145	2370	3450	1360	980	5	119.00	0.32	2.09	3.11	2.04
23944	MB	220	300	60	555	1036	1100	1400	2.1	13.50	0.18	3.75	5.58	3.70
23044	MB	220	340	90	1025	1730	1000	1300	3.0	31.50	0.24	2.81	4.19	2.80
24044	MB	220	340	118	1190	2098	750	1000	3.0	39.50	0.36	1.88	2.79	1.90
23144	MB	220	370	120	1455	2380	900	1200	4.0	54.50	0.31	2.18	3.24	2.20
22244	MB	220	400	108	1485	2483	850	1100	4.0	63.00	0.30	2.25	3.35	2.30
24144	MB	220	370	150	1780	3109	530	700	4.0	65.00	0.43	1.57	2.34	1.60
23244	MB	220	400	144	1850	2899	600	800	4.0	82.50	0.38	1.78	2.64	1.80
22248	CA	240	440	120	1970	2870	1000	1400	4.0	80.70	0.28	2.45	3.64	2.39
23048	CA	240	360	92	1130	2080	870	1200	3.0	34.30	0.24	2.81	4.19	2.75
23148	CA	240	400	128	1680	3060	700	930	4.0	66.30	0.32	2.13	3.17	2.08
24048	CA	240	360	118	1400	2680	620	830	3.0	43.60	0.31	2.21	3.29	2.16
24148	CA	240	400	160	2110	3880	520	700	4.0	83.80	0.39	1.74	2.59	1.70
22348	CA	240	500	155	2740	3990	800	650	5	149.00	0.32	2.09	3.11	2.04
23948	MB	240	320	60	600	1170	1000	1300	2.1	14.00	0.18	3.75	5.58	3.90
23048	MB	240	360	92	1105	1969	900	1200	3.0	34.50	0.24	2.81	4.19	2.80
23148	MB	240	400	128	1640	2720	850	1100	4.0	67.50	0.31	2.18	3.24	2.20
24148	MB	240	400	160	1970	3477	480	630	4.0	80.50	0.43	1.57	2.34	1.60
22248	MB	240	440	120	1815	2701	750	1000	4.0	85.50	0.30	2.25	3.35	2.30
23248	MB	240	440	160	2370	3837	560	750	4.0	110.00	0.38	1.78	2.64	1.80
23952	CA	260	360	75	902	1750	1100	1500	2.1	21.60	0.18	3.80	5.60	3.60
23052	CA	260	400	104	1350	2550	900	1200	4.0	49.80	0.23	2.90	4.40	2.80

Bearing		Principal Dimencions			Basic Load Ratings		Speed Ratings		Radius (Mm) R _{smin}	Weight (Kg) G	Calculation Factors			
Type	Cage	Bore (Mm) D	Outer (Mm) D	Width (Mm) B	Dynamic (Kn) C _r	Static (Kn) C _{or}	Grease (Rpm)	Oil (Rpm)			E	Y ₁	Y ₂	Y _o
24052	CA	260	400	140	1710	3500	700	900	4.0	66.70	0.33	2.00	3.00	2.00
23152	CA	260	440	144	2190	4050	800	1000	4.0	88.90	0.31	2.20	3.30	2.20
24152	CA	260	440	180	2100	4350	430	530	4.0	115.0	0.39	1.73	2.58	1.69
22252	CA	260	480	130	2280	3600	850	1100	5.0	106.0	0.27	2.51	3.74	2.45
23252	CA	260	480	174	2800	4750	630	800	5.0	141.0	0.35	1.90	2.90	1.80
22352	CA	260	540	165	3080	4750	630	800	6.0	186.0	0.31	2.20	3.30	2.20
22256	CA	280	500	130	2320	3590	1400	1000	5	117.20	0.26	2.6	3.87	2.54
23856	CA	280	350	52	435	1230	1200	1500	2.0	11.4	0.13	5.36	7.98	5.24
23956	CA	280	380	75	803	1850	1000	1400	2.1	25.7	0.18	3.80	5.66	3.72
23056	CA	280	420	106	1450	2850	850	1100	4.0	56.8	0.23	2.91	4.40	2.84
24056	CA	280	420	140	1780	3700	670	850	4.0	69.2	0.31	2.20	3.30	2.20
23156	CA	280	460	146	2190	4150	750	950	5.0	104.0	0.30	2.30	3.40	2.20
24156	CA	280	460	180	2530	4750	400	500	5.0	119.0	0.40	1.70	2.50	1.60
23256	CA	280	500	176	2840	5100	600	750	5.0	147.0	0.35	1.90	2.90	1.80
22356	CA	280	580	175	3520	5700	600	750	6.0	221.0	0.30	2.30	3.40	2.20
23860	CA	300	380	60	640	1650	950	1400	3.0	18.2	0.13	5.20	7.70	5.00
23960	CA	300	420	90	1160	2500	950	1300	3.0	40.1	0.19	3.60	5.30	3.60
23060	CA	300	460	118	1770	3450	800	1000	4.0	75.8	0.23	2.90	4.40	2.80
24060	CA	300	460	160	2220	2700	600	750	4.0	99.0	0.32	2.09	3.11	2.04
23160	CA	300	500	160	2680	4750	670	850	5.0	126.0	0.30	2.30	3.40	2.20
24160	CA	300	500	200	3100	6000	600	750	5.0	161.0	0.39	1.75	2.61	1.71
22260	CA	300	540	140	2620	4300	750	950	5.0	138.0	0.26	2.60	3.90	2.50
23260	CA	300	540	192	3300	5600	530	670	5.0	192.0	0.35	1.90	2.90	1.80
23864	CA	320	400	60	670	1620	920	1280	2.1	20.3	0.12	5.60	8.40	5.60
23964	CA	320	440	90	1200	2650	900	1200	3.0	42.7	0.18	3.80	5.60	3.60
23064	CA	320	480	121	1930	2200	800	1000	4.0	84.8	0.23	2.90	4.40	2.80
24064	CA	320	480	160	2480	5100	560	700	4.0	105.0	0.32	2.09	3.11	2.04
23164	CA	320	540	176	3150	3200	630	800	5.0	200.0	0.31	2.20	3.30	2.20
24164	CA	320	540	218	3560	6500	340	430	5.0	206.0	0.40	1.70	2.50	1.60
22264	CA	320	580	150	3000	4550	670	850	5.0	175.0	0.26	2.60	3.90	2.50



Spherical Roller Bearings

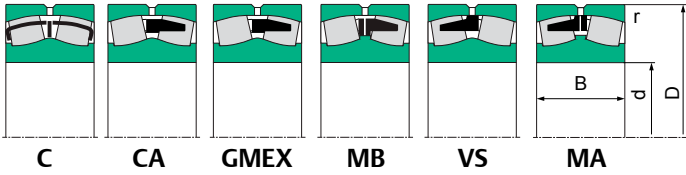

Bearing		Principal Dimensions			Basic Load Ratings		Speed Ratings		Radius (Mm) R _{smin}	Weight (Kg) G	Calculation Factors			
Type	Cage	Bore (Mm) D	Outer (Mm) D	Width (Mm) B	Dynamic (Kn) C _r	Static (Kn) C _{or}	Grease (Rpm)	Oil (Rpm)			E	Y ₁	Y ₂	Y _o
23264	CA	320	580	208	3900	6800	500	630	5.0	253.0	0.35	1.90	2.90	1.80
23968	CA	340	460	90	1200	2700	900	1200	3.0	46.0	0.17	4.00	5.90	4.00
23068	CA	340	520	133	2180	4400	700	900	5.0	115.0	0.24	2.80	4.20	2.80
24068	CA	340	520	180	2710	5700	530	670	5.0	137.0	0.33	2.00	3.00	2.00
23168	CA	340	580	190	3500	6300	600	750	5.0	211.0	0.31	2.20	3.30	2.20
24168	CA	340	580	243	4400	7950	320	400	5.0	256.0	0.40	1.70	2.50	1.60
23268	CA	340	620	224	4400	7700	430	530	6.0	297.0	0.35	1.90	2.90	1.80
23972	CA	360	480	90	1290	2820	850	1100	3.0	46.6	0.16	4.20	6.30	4.00
23072	CA	360	540	134	2280	4800	670	850	5.0	126.0	0.23	2.90	4.40	2.80
24072	CA	360	540	180	2820	6100	600	750	5.0	150.0	0.31	2.20	3.30	2.20
23172	CA	360	600	192	3580	6850	560	700	5.0	255.0	0.30	2.30	3.40	2.20
24172	CA	360	600	243	5600	8400	300	380	5.0	270.0	0.37	1.80	2.70	1.80
22272	CA	360	650	170	3630	6200	380	480	6.0	253.0	0.26	2.60	3.87	2.54
23272	CA	360	650	232	4650	8300	400	500	6.0	335.0	0.35	1.90	2.90	1.80
22372	CA	360	750	224	4900	8600	400	500	7.5	460.0	0.31	2.21	3.29	2.16
23976	CA	380	520	106	1730	3800	800	1000	4.0	69.5	0.17	4.00	5.90	4.00
23076	CA	380	560	135	2480	5000	630	800	5.0	130.0	0.22	3.00	4.60	2.80
24076	CA	380	560	180	3150	6900	480	600	5.0	150.0	0.30	2.30	3.40	2.20
23176	CA	380	620	194	3740	7350	400	500	5.0	250.0	0.30	2.30	3.40	2.20
24176	CA	380	620	243	4400	9200	300	380	5.0	296.0	0.30	2.30	3.40	2.20
23276	CA	380	680	240	4800	9200	380	480	6.0	386.0	0.35	1.90	2.90	1.80
23980	CA	400	540	106	1750	3950	750	950	4.0	72.4	0.17	4.00	5.90	4.00
23080	CA	400	590	142	2650	5600	630	800	5.0	133.0	0.21	3.14	4.68	3.07
24080	CA	400	600	200	3600	7800	450	560	5.0	202.0	0.30	2.30	3.40	2.20
23180	CA	400	650	200	4100	7650	380	480	6.0	275.0	0.28	2.40	3.60	2.50
24180	CA	400	650	250	4800	9600	320	400	6.0	326.0	0.36	1.87	2.79	1.83
23280	CA	400	720	256	6150	11300	340	430	6.0	350.0	0.35	1.90	2.90	1.80
22380	CA	400	820	243	5400	9600	340	430	7.5	623.0	0.31	2.21	3.29	2.16
23984	CA	420	560	106	1530	4050	700	900	4.0	72.4	0.16	4.20	6.30	4.00
23084	CA	420	620	150	2970	6400	450	560	5.0	150.0	0.22	3.00	4.60	2.80

Bearing		Principal Dimencions			Basic Load Ratings		Speed Ratings		Radius (Mm) R _{smin}	Weight (Kg) G	Calculation Factors			
Type	Cage	Bore (Mm) D	Outer (Mm) D	Width (Mm) B	Dynamic (Kn) C _r	Static (Kn) C _{0r}	Grease (Rpm)	Oil (Rpm)			E	Y ₁	Y ₂	Y ₀
24084	CA	420	620	200	3690	8450	380	480	5.0	202.0	0.30	2.30	3.40	2.20
23184	CA	420	700	224	4680	9200	360	450	6.0	353.0	0.30	2.30	3.40	2.20
24184	CA	420	700	280	5750	11100	300	380	6.0	436.0	0.38	1.80	2.60	1.70
23284	CA	420	760	272	6170	11900	320	400	7.5	550.0	0.35	1.90	2.90	1.80
23988	CA	440	600	118	2030	4850	450	560	4.0	101.0	0.17	4.00	5.90	4.00
23088	CA	440	650	157	3060	6500	430	530	6.0	179.0	0.22	3.00	4.60	2.80
24088	CA	440	650	212	4150	9100	360	450	6.0	251.0	0.30	2.30	3.40	2.20
23188	CA	440	720	226	4950	10000	340	430	6.0	378.0	0.30	2.30	3.40	2.20
24188	CA	440	720	280	7300	13400	300	380	6.0	469.0	0.37	1.80	2.70	1.80
23288	CA	440	790	280	7600	12300	320	400	7.5	612.0	0.35	1.90	2.90	1.80
24892	CA	460	580	118	1730	4850	450	560	3.0	82.0	0.17	4.00	5.90	4.00
23992	CA	460	620	118	2120	5000	430	530	4.0	105.0	0.16	4.20	6.30	4.00
23092	CA	460	680	163	3280	6950	400	500	6.0	226.0	0.22	3.00	4.60	2.80
24092	CA	460	680	218	4200	9100	340	430	6.0	304.0	0.29	2.35	3.50	2.30
23192	CA	460	760	240	5500	10000	320	400	7.5	443.0	0.30	2.30	3.40	2.20
24192	CA	460	760	300	6890	14400	160	200	7.5	461.0	0.37	1.80	2.70	1.80
23292	CA	460	830	296	7350	13500	300	380	7.5	698.0	0.35	1.90	2.90	1.80
23896	CA	480	600	90	1420	4000	450	600	3.0	60.4	0.13	5.36	7.98	5.24
23996	CA	480	650	128	2370	5750	400	500	5.0	126.0	0.18	3.80	5.60	3.60
23096	CA	480	700	165	3300	6900	380	480	6.0	217.0	0.21	3.20	4.80	3.20
24096	CA	480	700	218	5250	10200	340	430	6.0	296.0	0.28	2.40	3.60	2.50
23196	CA	480	790	248	6100	12000	300	380	7.5	516.0	0.30	2.30	3.40	2.20
24196	CA	480	790	308	8000	14900	240	320	7.5	584.0	0.37	1.80	2.70	1.80
23296	CA	480	870	310	7750	15200	260	340	7.5	853.0	0.35	1.90	2.90	1.80
238/500	CA	500	620	90	1450	3800	420	520	3.0	66.0	0.12	5.60	8.40	5.60
239/500	CA	500	670	128	2530	6000	400	500	5.0	120.0	0.17	4.00	5.90	4.00
230/500	CA	500	720	167	3470	7650	380	480	6.0	228.0	0.21	3.20	4.80	3.20
240/500	CA	500	720	218	5400	10600	420	520	6.0	306.0	0.26	2.60	3.90	2.50
231/500	CA	500	830	264	6100	13800	320	400	7.5	588.0	0.30	2.30	3.40	2.20
241/500	CA	500	830	325	9600	16000	300	380	7.5	736.0	0.37	1.80	2.70	1.80



Spherical Roller Bearings

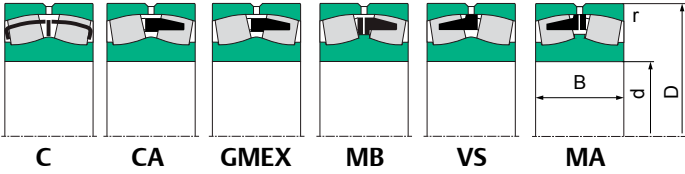

Bearing		Principal Dimensions			Basic Load Ratings		Speed Ratings		Radius (Mm) R _{smin}	Weight (Kg) G	Calculation Factors			
Type	Cage	Bore (Mm) D	Outer (Mm) D	Width (Mm) B	Dynamic (Kn) C _r	Static (Kn) C _{0r}	Grease (Rpm)	Oil (Rpm)			E	Y ₁	Y ₂	Y ₀
232/500	CA	500	920	336	9460	18600	280	360	7.5	985.0	0.35	1.90	2.90	1.80
238/530	CA	530	650	90	1500	4200	400	500	3.0	64.2	0.12	5.60	8.40	5.60
248/530	CA	530	650	118	1820	5280	380	480	3.0	91.0	0.15	4.50	6.70	4.50
239/530	CA	530	710	316	2900	6700	360	450	5.0	154.0	0.17	4.00	5.90	4.00
230/530	CA	530	780	185	4290	9650	340	430	6.0	339.0	0.22	3.00	4.60	2.80
240/530	CA	530	780	250	5400	12700	280	360	6.0	416.0	0.29	2.30	3.50	2.40
231/530	CA	530	870	272	8100	13200	260	340	7.5	665.0	0.30	2.30	3.40	2.20
241/530	CA	530	870	335	10300	18700	190	280	7.5	846.0	0.37	1.80	2.80	1.80
232/530	CA	530	980	335	10300	20300	210	290	9.5	1220	0.36	1.87	2.79	1.83
239/560	CA	560	750	140	3050	7200	340	430	5.0	177.0	0.16	4.20	6.30	4.00
230/560	CA	560	820	195	4300	10500	320	410	6.0	363.0	0.22	3.14	4.67	3.07
240/560	CA	560	820	258	5700	13200	220	300	6.0	471.0	0.28	2.40	3.60	2.50
231/560	CA	560	920	280	7590	15700	240	320	7.5	756.0	0.30	2.30	3.40	2.20
241/560	CA	560	920	355	10000	20100	120	160	7.5	953.0	0.37	1.80	2.80	1.80
232/560	CA	560	1030	365	11200	21000	190	260	9.5	1380	0.35	1.90	2.90	1.80
239/600	CA	600	800	150	3260	8400	320	400	5.0	220.0	0.17	4.00	5.90	4.00
249/600	CA	600	800	200	4070	11200	320	400	5.0	287.0	0.22	3.00	4.60	2.80
230/600	CA	600	870	200	5170	11600	300	380	6.0	442.0	0.22	3.00	4.60	2.80
240/600	CA	600	870	272	8100	16500	220	300	6.0	560.0	0.30	2.30	3.40	2.80
231/600	CA	600	980	300	8900	18800	180	250	7.5	894.0	0.29	2.30	3.50	2.40
241/600	CA	600	980	375	10000	21600	110	150	7.5	1140	0.36	1.90	2.82	1.85
232/600	CA	600	1090	388	12500	25000	190	260	9.5	1568	0.35	1.93	2.88	1.80
238/630	CA	630	780	112	2200	6300	300	380	4.0	124.0	0.12	5.60	8.40	5.60
239/630	CA	630	850	165	3550	9750	280	360	6.0	280.0	0.17	4.00	5.90	4.00
230/630	CA	630	920	212	5670	12800	260	340	7.5	471.0	0.21	3.20	4.80	3.20
231/630	CA	630	1030	315	10000	21000	180	250	7.5	1080	0.30	2.30	3.40	2.20
241/630	CA	630	1030	400	12500	27200	160	210	7.5	1440	0.37	1.80	2.70	1.80
238/670	CA	670	820	112	2210	6300	270	350	4.0	136.0	0.11	6.10	9.10	6.30
248/670	CA	670	820	150	3100	9600	270	350	4.0	178.0	0.16	4.20	6.30	4.00
239/670	CA	670	900	170	4400	10600	260	340	6.0	313.0	0.17	4.00	5.90	4.00

Bearing		Principal Dimencions			Basic Load Ratings		Speed Ratings		Radius (Mm) R _{smin}	Weight (Kg) G	Calculation Factors			
Type	Cage	Bore (Mm) D	Outer (Mm) D	Width (Mm) B	Dynamic (Kn) C _r	Static (Kn) C _{0r}	Grease (Rpm)	Oil (Rpm)			E	Y ₁	Y ₂	Y ₀
230/670	CA	670	980	230	6900	15000	240	310	7.5	601.0	0.22	3.00	4.60	3.20
240/670	CA	670	980	308	9500	20000	190	270	7.5	807.0	0.28	2.40	3.60	2.50
231/670	CA	670	1090	336	11000	22500	175	240	7.5	1280	0.30	2.30	3.40	2.20
241/670	CA	670	1090	412	14000	31500	150	190	7.5	1560	0.36	1.87	2.79	1.83
232/670	CA	670	1220	438	15000	32000	160	210	12.0	2300	0.35	1.90	2.90	1.80
238/710	CA	710	870	118	2680	7550	260	340	4.0	156.0	0.11	6.10	9.10	6.30
239/710	CA	710	950	180	5000	12000	240	310	6.0	364.0	0.17	4.00	5.90	4.00
249/710	CA	710	950	243	6200	17000	200	280	6.0	500.0	0.22	3.00	4.60	2.80
230/710	CA	710	1030	236	6300	16200	220	300	7.5	669.0	0.21	3.20	4.80	3.20
240/710	CA	710	1030	315	9300	22500	180	250	7.5	910.0	0.27	2.50	3.70	2.50
231/710	CA	710	1150	345	12000	25800	170	220	9.8	1480	0.28	2.40	3.60	2.50
241/710	CA	710	1150	438	11900	29700	90	120	9.5	1791	0.35	1.90	2.90	1.80
232/710	CA	710	1280	450	17500	34400	160	210	12.0	2640	0.35	1.90	2.90	1.80
238/750	CA	750	920	128	2950	8600	240	310	5.0	188.0	0.11	6.10	9.10	6.30
239/750	CA	750	1000	185	5800	13500	210	290	6.0	426.0	0.16	4.20	6.30	4.00
249/750	CA	750	1000	250	7600	18200	180	250	6.0	566.0	0.22	3.00	4.60	2.80
230/750	CA	750	1090	250	7000	17900	200	280	7.5	789.0	0.21	3.20	4.80	3.20
240/750	CA	750	1090	335	10000	24800	170	220	7.5	1100	0.28	2.40	3.60	2.50
231/750	CA	750	1220	365	13500	28800	160	210	9.5	1760	0.28	2.40	3.60	2.50
241/750	CA	750	1220	475	16000	37000	130	170	9.5	2195	0.35	1.90	2.90	1.80
232/750	CA	750	1360	475	16390	36000	90	120	15.0	3100	0.36	1.87	2.79	1.83
248/800	CA	800	980	180	4150	13000	170	220	5.0	330.0	0.15	4.50	6.70	4.50
239/800	CA	800	1060	195	6350	14200	190	270	6.0	480.0	0.16	4.20	6.30	4.00
249/800	CA	800	1060	258	7800	19500	175	240	6.0	648.0	0.21	3.20	4.80	3.20
230/800	CA	800	1150	258	8090	19100	170	220	7.5	894.0	0.20	3.40	5.00	3.20
240/800	CA	800	1150	345	10300	24600	170	220	7.5	1092	0.27	2.50	3.70	2.50
231/800	CA	800	1280	375	14500	31000	150	190	9.5	1960	0.28	2.40	3.60	2.50
241/800	CA	800	1280	475	16300	37100	130	170	9.5	2350	0.35	1.90	2.90	1.80
238/850	CA	850	1030	136	3300	9800	180	250	5.0	244.0	0.11	6.10	9.10	6.30
239/850	CA	850	1120	200	5800	15500	180	250	6.0	570.0	0.16	4.20	6.30	4.00



Spherical Roller Bearings

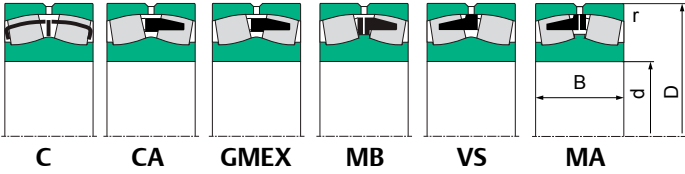

Bearing		Principal Dimensions			Basic Load Ratings		Speed Ratings		Radius (Mm) R _{smin}	Weight (Kg) G	Calculation Factors			
Type	Cage	Bore (Mm) D	Outer (Mm) D	Width (Mm) B	Dynamic (Kn) C _r	Static (Kn) C _{0r}	Grease (Rpm)	Oil (Rpm)			E	Y ₁	Y ₂	Y ₀
249/850	CA	850	1120	272	8200	22500	170	220	6.0	750.0	0.22	3.00	4.60	2.80
230/850	CA	850	1220	272	8450	22500	180	240	7.5	1074	0.20	3.40	5.00	3.20
240/850	CA	850	1220	365	11400	29700	160	200	7.5	1410	0.27	2.50	3.70	2.50
231/850	CA	850	1360	400	16000	34200	130	170	12.0	2260	0.28	2.40	3.60	2.50
241/850	CA	850	1360	500	20000	45100	105	140	12.0	2750	0.35	1.90	2.90	1.80
248/900	CA	900	1090	190	4890	15500	210	375	5.0	370.0	0.14	4.80	7.20	4.50
239/900	CA	900	1180	206	6050	16400	180	240	6.0	611.0	0.15	4.50	6.70	4.50
230/900	CA	900	1280	280	10200	23500	160	210	7.5	1220	0.20	3.40	5.00	3.20
240/900	CA	900	1280	375	13000	34200	140	190	7.5	1600	0.26	2.60	3.90	2.50
241/900	CA	900	1420	515	21000	48500	95	140	12.0	3400	0.35	1.90	2.90	1.80
239/950	CA	950	1250	224	7350	19000	160	225	7.5	759.0	0.15	4.50	6.70	4.50
249/950	CA	950	1250	300	9300	25500	135	180	7.5	1030	0.21	3.20	4.80	3.20
230/950	CA	950	1360	300	11000	26800	150	210	7.5	1440	0.20	3.40	5.00	3.20
240/950	CA	950	1360	412	15000	38500	125	160	7.5	2100	0.27	2.50	3.70	2.50
241/950	CA	950	1500	545	24000	54500	90	125	7.5	3600	0.35	1.90	2.90	1.80
239/950	CAF	950	1250	224	7310	19500	260	340	7.5	755.0	0.15	4.50	6.70	4.50
240/950	CAF	950	1360	412	15210	39375	180	240	7.5	1990	0.27	2.50	3.72	2.50
238/1000	CA	1000	1220	165	4400	13600	125	160	6.0	402.0	0.11	5.92	8.81	5.78
249/1000	CA	1000	1320	315	10200	29200	125	160	7.5	1220	0.21	3.20	4.80	3.20
230/1000	CA	1000	1420	308	12700	30500	130	175	7.5	1590	0.19	3.60	5.30	3.60
240/1000	CA	1000	1420	412	15200	40500	110	150	7.5	2130	0.26	2.60	3.90	2.50
231/1000	CA	1000	1580	462	21500	48200	95	130	12.0	3520	0.28	2.40	3.50	2.50
241/1000	CA	1000	1580	580	26500	62200	85	110	12.0	4350	0.35	1.90	2.90	1.80
238/1060	CA	1060	1280	165	4700	14800	150	195	6.0	440.0	0.11	6.10	9.10	6.30
248/1060	CA	1060	1280	218	6000	19500	125	160	6.0	576.0	0.14	4.80	7.20	4.50
239/1060	CA	1060	1400	250	9350	25000	145	170	7.5	1041	0.16	4.20	6.30	4.00
249/1060	CA	1060	1400	335	11000	32600	115	150	7.5	1420	0.21	3.20	4.80	3.20
230/1060	CA	1060	1500	325	13500	33000	125	160	9.5	2300	0.19	3.60	5.30	3.60
240/1060	CA	1060	1500	438	17000	46000	100	145	9.5	2530	0.26	2.60	3.90	2.50
248/1120	CA	1120	1360	243	7150	23500	105	165	6.0	740.0	0.15	4.50	6.70	4.50

Bearing		Principal Dimencions			Basic Load Ratings		Speed Ratings		Radius (Mm) R _{smin}	Weight (Kg) G	Calculation Factors			
Type	Cage	Bore (Mm) D	Outer (Mm) D	Width (Mm) B	Dynamic (Kn) C _r	Static (Kn) C _{or}	Grease (Rpm)	Oil (Rpm)			E	Y1	Y2	Yo
249/1120	CA	1120	1460	335	12000	35200	90	135	7.5	1500	0.20	3.40	5.00	3.20
230/1120	CA	1120	1580	345	15000	38100	90	125	9.5	2210	0.19	3.40	5.00	3.20
240/1120	CA	1120	1580	462	18100	49500	90	125	9.5	2940	0.26	2.60	3.90	2.50
238/1180	CA	1180	1420	180	5600	18000	150	190	6.0	577.0	0.11	6.28	9.35	6.14
248/1180	CA	1180	1420	243	7700	27200	135	160	6.0	790.0	0.14	4.80	7.20	4.50
239/1180	CA	1180	1540	272	10290	29600	110	150	7.5	1350	0.16	4.20	6.30	4.00
249/1180	CA	1180	1540	355	13310	40000	110	150	7.5	1772	0.20	3.42	5.09	3.34
230/1180	CA	1180	1660	355	10290	29600	110	150	9.5	2460	0.20	3.42	5.09	3.34
230/1250	CA	1250	1750	375	17500	44800	95	125	9.5	2850	0.19	3.60	5.30	3.60
248/1320	CA	1320	1600	280	9750	33400	85	115	6.0	1180	0.15	4.50	6.70	4.50
249/1320	CA	1320	1720	400	16000	49200	80	105	7.5	2510	0.21	3.20	4.80	3.20
240/1320	CA	1320	1850	530	23200	63300	70	85	12.0	4540	0.25	2.70	4.00	2.60
249/1400	CA	1400	1820	425	20000	58500	70	85	9.5	2920	0.20	3.42	5.09	3.34
248/1500	CA	1500	1820	315	12000	40000	65	83	7.5	1730	0.15	4.50	6.70	4.50
248/1800	CA	1800	2180	375	17400	62800	62	70	9.5	2920	0.15	4.50	6.70	4.50





ADAPTER SLEEVES

Dimensions in accordance with ISO 2982-1995

Adapter sleeves are used to locate tapered bore bearings on cylindrical shafts. This allows less accurate machining of the shafts and ease of location.

Adapter sleeves are available in metric or inch bore sizes - the external taper is 1:12.

See page 72 for tolerances.

Hydraulic sleeves are available from 200mm bore diameter. Suffix: OH

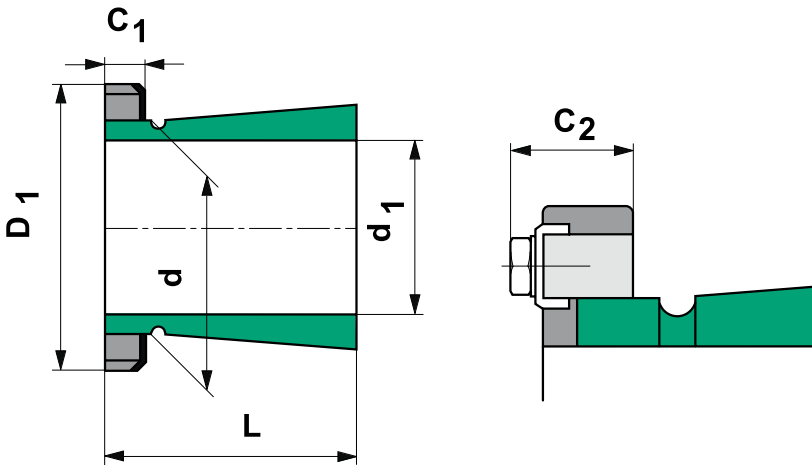

Adapter Sleeve

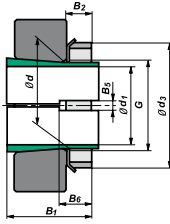

Bearing		ISO dimensions						Weight kg	Locking nut	Locking device
Type	Version	d1 mm	d	d3	B1 kN	B2 kN	G			
H 204		17	20	32	24	7	M 20x1	0,041	KM 4	MB 4
H 2304		17	20	32	31	7	M 20x1	0,049	KM 4	MB 4
H 304		17	20	32	28	7	M 20x1	0,045	KM 4	MB 4
H 205		20	25	38	26	8	M 25x1,5	0,070	KM 5	MB 5
H 2305		20	25	38	35	8	M 25x1,5	0,087	KM 5	MB 5
H 305		20	25	38	29	8	M 25x1,5	0,075	KM 5	MB 5
H 206		25	30	45	27	8	M 30x1,5	0,099	KM 6	MB 6
H 2306		25	30	45	38	8	M 30x1,5	0,126	KM 6	MB 6
H 306		25	30	45	31	8	M 30x1,5	0,109	KM 6	MB 6
H 207		30	35	52	29	9	M 35x1,5	0,125	KM 7	MB 7
H 2307		30	35	52	43	9	M 35x1,5	0,165	KM 7	MB 7
H 307		30	35	52	35	9	M 35x1,5	0,142	KM 7	MB 7
H 208		35	40	58	31	10	M 40x1,5	0,174	KM 8	MB 8
H 2308		35	40	58	46	10	M 40x1,5	0,224	KM 8	MB 8
H 308		35	40	58	36	10	M 40x1,5	0,189	KM 8	MB 8
HE 308		31,75	40	58	36	10	M 40x1,5	0,220	KM 8	MB 8
H 209		40	45	65	33	11	M 45x1,5	0,227	KM 9	MB 9
H 2309		40	45	65	50	11	M 45x1,5	0,280	KM 9	MB 9
H 309		40	45	65	39	11	M 45x1,5	0,248	KM 9	MB 9
H 210		45	50	70	35	12	M 50x1,5	0,274	KM 10	MB 10
H 2310		45	50	70	55	12	M 50x1,5	0,362	KM 10	MB 10
H 310		45	50	70	42	12	M 50x1,5	0,303	KM 10	MB 10
H 211		50	55	75	37	12,5	M 55x2	0,308	KM 11	MB 11
H 2311		50	55	75	59	12,5	M 55x2	0,420	KM 11	MB 11

Bearing		ISO dimensions						Weight kg	Locking nut	Locking device
Type	Version	d1 mm	d	d3	B1 kN	B2 kN	G			
H 311		50	55	75	45	12,5	M 55x2	0,345	KM 11	MB 11
H 212		55	60	80	38	13	M 60x2	0,346	KM 12	MB 12
H 2312		55	60	80	62	13	M 60x2	0,481	KM 12	MB 12
H 312		55	60	80	47	13	M 60x2	0,394	KM 12	MB 12
H 213		60	65	85	40	14	M 65x2	0,401	KM 13	MB 13
H 214		60	70	92	41	14	M 70x2	0,593	KM 14	MB 14
H 2313		60	65	85	65	14	M 65x2	0,557	KM 13	MB 13
H 2314		60	70	92	68	14	M 70x2	0,897	KM 14	MB 14
H 313		60	65	85	50	14	M 65x2	0,458	KM 13	MB 13
H 314		60	70	92	52	14	M 70x2	0,723	KM 14	MB 14
H 215		65	75	98	43	15	M 75x2	0,707	KM 15	MB 15
H 2315		65	75	98	73	15	M 75x2	1,050	KM 15	MB 15
H 315		65	75	98	55	15	M 75x2	0,831	KM 15	MB 15
H 216		70	80	105	46	17	M 80x2	0,882	KM 16	MB 16
H 2316		70	80	105	78	17	M 80x2	1,280	KM 16	MB 16
H 316		70	80	105	59	17	M 80x2	1,030	KM 16	MB 16
H 217		75	85	110	50	18	M 85x2	1,020	KM 17	MB 17
H 2317		75	85	110	82	18	M 85x2	1,450	KM 17	MB 17
H 317		75	85	110	63	18	M 85x2	1,180	KM 17	MB 17
H 218		80	90	120	52	18	M 90x2	1,190	KM 18	MB 18
H 2318		80	90	120	86	18	M 90x2	1,690	KM 18	MB 18
H 318		80	90	120	65	18	M 90x2	1,370	KM 18	MB 18
H 219		85	95	125	55	19	M 95x2	1,370	KM 19	MB 19
H 2319		85	95	125	90	19	M 95x2	1,920	KM 19	MB 19



Adapter Sleeve

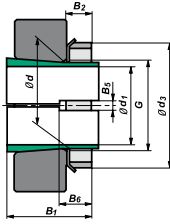

Bearing		ISO dimensions						Weight kg	Locking nut	Locking device
Type	Version	d1 mm	d	d3	B1 kN	B2 kN	G			
H 319		85	95	125	68	19	M 95x2	1,560	KM 19	MB 19
H 220		90	100	130	58	20	M 100x2	1,490	KM 20	MB 20
H 2320		90	100	130	97	20	M 100x2	2,150	KM 20	MB 20
H 3120		90	100	130	76	20	M 100x2	1,800	KM 20	MB 20
H 320		90	100	130	71	20	M 100x2	1,690	KM 20	MB 20
H 221		95	105	140	60	20	M 105x2	1,720	KM 21	MB 21
H 321		95	105	140	74	20	M 105x2	1,950	KM 21	MB 21
H 222		100	110	145	63	21	M 110x2	1,930	KM 22	MB 22
H 2322		100	110	145	105	21	M 110x2	2,740	KM 22	MB 22
H 3122		100	110	145	81	21	M 110x2	2,250	KM 22	MB 22
H 322		100	110	145	77	21	M 110x2	2,180	KM 22	MB 22
H 2324		110	120	155	112	22	M 120x2	3,190	KM 24	MB 24
H 3024		110	120	145	72	22	M 120x2	1,930	KML 24	MBL 24
H 3124		110	120	155	88	22	M 120x2	2,640	KM 24	MB 24
H 2326		115	130	165	121	23	M 130x2	4,600	KM 26	MB 26
H 3026		115	130	155	80	23	M 130x2	2,850	KML 26	MBL 26
H 3126		115	130	165	92	23	M 130x2	3,660	KM 26	MB 26
H 2328		125	140	180	131	24	M 140x2	5,550	KM 28	MB 28
H 3028		125	140	165	82	24	M 140x2	3,160	KML 28	MBL 28
H 3128		125	140	180	97	24	M 140x2	4,340	KM 28	MB 28
H 2330		135	150	195	139	26	M 150x2	6,630	KM 30	MB 30
H 3030		135	150	180	87	26	M 150x2	3,890	KML 30	MBL 30
H 3130		135	150	195	111	26	M 150x2	5,520	KM 30	MB 30
H 2332		140	160	210	147	28	M 160x3	9,140	KM 32	MB 32

Bearing		ISO dimensions						Weight kg	Locking nut	Locking device
Type	Version	d1 mm	d	d3	B1 kN	B2 kN	G			
H 3032		140	160	190	93	27,5	M 160x3	5,210	KML 32	MBL 32
H 3132		140	160	210	119	28	M 160x3	7,670	KM 32	MB 32
H 2334		150	170	220	154	29	M 170x3	10,200	KM 34	MB 34
H 3034		150	170	200	101	28,5	M 170x3	5,990	KML 34	MBL 34
H 3134		150	170	220	122	29	M 170x3	8,380	KM 34	MB 34
H 2336		160	180	230	161	30	M 180x3	11,300	KM 36	MB 36
H 2336	OH	160	180	230	161	30	Tr180x3	11,000	KM36	MB36
H 3036		160	180	210	109	29,5	M 180x3	6,830	KML 36	MBL 36
H 3036	OH	160	180	210	109	29,5	Tr180x3	6,700	KML36	MBL36
H 3136		160	180	230	131	30	M 180x3	9,500	KM 36	MB 36
H 3136	OH	160	180	230	131	30	M180X3	9,150	KM36	MB36
H 3936		160	180	210	87	29,5	M180x3	5,700	KML36	MBL36
H 2338		170	190	240	169	31	M 190x3	12,600	KM 38	MB 38
H 2338	OH	170	190	240	169	31	Tr190x3	12,000	KM38	MB38
H 3038		170	190	220	112	30,5	M 190x3	7,450	KML 38	MBL 38
H 3038	OH	170	190	220	112	30,5	Tr190x3	7,250	KML38	MBL38
H 3138		170	190	240	141	31	M 190x3	10,800	KM 38	MB 38
H 3138	OH	170	190	240	141	31	M190X3	10,500	KM38	MB38
H 3938		170	190	220	89	30,5	M190x3	6,190	KML38	MBL38
H 2340		180	200	250	176	32	M 200x3	13,900	KM 40	MB 40
H 2340	OH	180	200	250	176	32	Tr200x3	13,500	KM40	MB40
H 3040		180	200	240	120	31,5	M 200x3	9,190	KML 40	MBL 40
H 3040	OH	180	200	240	120	31,5	Tr200x3	8,900	KML40	MBL40
H 3140		180	200	250	150	32	M 200x3	12,100	KM 40	MB 40



Adapter Sleeve

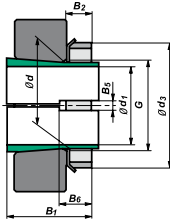

Bearing		ISO dimensions						Weight kg	Locking nut	Locking device
Type	Version	d1 mm	d	d3	B1 kN	B2 kN	G			
H 3140	OH	180	200	250	150	32	M200x3	12,000	KM40	MB40
H 3940		180	200	240	98	31,5	M200x3	7,890	KML40	MBL40
H 2344		200	220	280	186	35	Tr220x4	17,000	HM 44 T	MB 44
H 2344	OH	200	220	280	186	35	Tr220x4	17,000	HM44T	MB44
H 3044		200	220	260	126	30	Tr220x4	10,300	HM3044	MS3044
H 3044	OH	200	220	260	126	30	Tr220x4	9,900	HM3044	MS3044
H 3144		200	220	280	161	35	Tr220x4	15,000	HM44T	MB44
H 3144	OH	200	220	280	161	35	Tr200x3	15,000	HM44T	MB44
H 3944		200	220	260	96	30	Tr220x4	8,160	HM3044	MS3044
H 2348		220	240	300	199	37	Tr 240x4	20,000	HM 48 T	MB 48
H 2348	OH	220	240	300	199	37	Tr240x4	19,000	HM48T	MB48
H 3048		220	240	290	133	34	Tr240x4	13,200	HM3048	MS3048
H 3048	OH	220	240	290	133	34	Tr240x4	12,000	HM3048	MS3052-48
H 3148		220	240	300	172	37	Tr240x4	17,600	HM48T	MB48
H 3148	OH	220	240	300	172	37	Tr240x4	16,500	HM48T	MB48
H 3948		220	240	290	101	34	Tr240x4	11,000	HM3048	MS3048
H 2352		240	260	330	211	39	Tr 260x4	24,500	HM 52 T	MB 52
H 2352	OH	240	260	330	211	39	Tr260x4	23,000	HM52T	MB52
H 3052		240	260	310	145	34	Tr260x4	13,500	HM3052	MS3052-48
H 3052		240	260	310	145	34	Tr260x4	15,300	HM3052	MS3052
H 3052	OH	240	260	310	145	34	Tr260x4	13,500	HM3052	MS3052-48
H 3152		240	260	330	190	39	Tr260x4	22,300	HM52T	MB52
H 3152	OH	240	260	330	190	39	Tr260x4	21,000	HM52T	MB52
H 3952		240	260	310	116	34	Tr260x4	12,800	HM3052	MS3052

Bearing		ISO dimensions						Weight kg	Locking nut	Locking device
Type	Version	d1 mm	d	d3	B1 kN	B2 kN	G			
H 2356		260	280	350	224	41	Tr 280x4	28,400	HM 56 T	MB 56
H 2356	OH	260	280	350	224	41	Tr280x4	27,000	HM56T	MB56
H 3056		260	280	330	152	38	Tr280x4	17,700	HM3056	MS3056
H 3056	OH	260	280	330	152	38	Tr280x4	16,000	HM3056	MS3056
H 3156		260	280	350	195	41	Tr280x4	25,100	HM56T	MB56
H 3156	OH	260	280	330	195	41	Tr280x4	19,300	HM3056	MS3056
H 3956		260	280	330	121	38	Tr280x4	15,300	HM3056	MS3056
H 3060		280	300	360	168	42	Tr300x4	20,500	HM3060	MS3060
H 3060		280	300	360	168	42	Tr300x4	22,800	HM3060	MS3060
H 3060	OH	280	300	360	168	42	Tr300x4	20,500	HM3060	MS3060
H 3160		280	300	380	208	40	Tr300x4	30,200	HM3160	MS3160
H 3160	OH	280	300	380	208	40	Tr300x4	29,000	HM3160	MS3160
H 3260		280	300	380	240	40	Tr300x4	34,100	HM3160	MS3160
H 3260	OH	280	300	380	240	40	Tr300x4	32,000	HM3160	MS3160
H 3960		280	300	360	140	42	Tr300x4	20,000	HM3060	MS3060
H 3064		300	320	380	171	42	Tr320x5	24,600	HM3064	MS3064
H 3064	OH	300	320	380	171	42	Tr320x5	22,000	HM3064	MS3068-64
H 3164		300	320	400	226	42	Tr320x5	34,900	HM3164	MS3164
H 3164	OH	300	320	400	226	42	Tr320x5	32,000	HM3164	MS3164
H 3264		300	320	400	258	42	Tr320x5	39,300	HM3164	MS3164
H 3264	OH	300	320	400	258	42	Tr320x5	35,000	HM3164	MS3164
H 3964		300	320	380	140	42	Tr320x5	21,500	HM3064	MS3064
H 3068		320	340	400	187	45	Tr340x5	28,700	HM3068	MS3068
H 3068	OH	320	340	400	187	45	Tr340x5	27,000	HM3068	MS3068-64



Adapter Sleeve

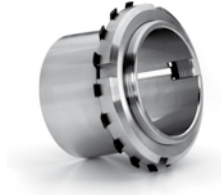
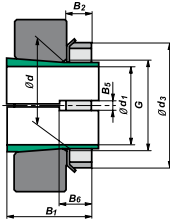

Bearing		ISO dimensions						Weight kg	Locking nut	Locking device
Type	Version	d1 mm	d	d3	B1 kN	B2 kN	G			
H 3168		320	340	440	254	55	Tr340x5	50,000	HM3168	MS3168
H 3168	OH	320	340	440	254	55	Tr340X5	50,000	HM3168	MS3172-68
H 3268		320	340	440	288	55	Tr340x5	54,600	HM3168	MS3168
H 3268	OH	320	340	440	288	55	Tr340x5	51,500	HM3168	MS3172-68
H 3968		320	340	400	144	45	Tr340x5	24,500	HM3068	MS3068
H 3072		340	360	420	188	45	Tr360x5	30,500	HM3072	MS3072
H 3072	OH	340	360	420	188	45	Tr360x5	29,000	HM3072	MS3072
H 3172		340	360	460	259	58	Tr360X5	56,000	HM3172	MS3172
H 3172	OH	340	360	460	259	58	Tr360X5	56,000	HM3172	MS3172-68
H 3272		340	360	460	299	58	Tr360x5	60,600	HM3172	MS3172
H 3272	OH	340	360	460	299	58	Tr360x5	60,500	HM3172	MS3172-68
H 3972		340	360	420	144	45	Tr360x5	25,200	HM3072	MS3072
H 3076		360	380	450	193	48	Tr380X5	35,800	HM3076	MS3076
H 3076	OH	360	380	450	193	48	Tr380X5	35,500	HM3076	MS3080-76
H 3176		360	380	490	264	60	Tr380X5	61,700	HM3176	MS3176
H 3176	OH	360	380	490	264	60	Tr380X5	61,500	HM3176	MS3176
H 3276		360	380	490	310	60	Tr380X5	69,600	HM3176	MS3176
H 3276	OH	360	380	490	310	60	Tr380X5	69,500	HM3176	MS3176
H 3976		360	380	450	164	48	Tr380x5	31,500	HM3076	MS3076
H 3080		380	400	470	210	52	Tr400x5	41,300	HM3080	MS3080
H 3080	OH	380	400	470	210	52	Tr400x5	40,000	HM3080	MS3080-76
H 3180		380	400	520	272	62	Tr400x5	73,000	HM3180	MS3180
H 3180	OH	380	400	520	272	62	Tr400x5	73,000	HM3180	MS3184-80
H 3280		380	400	520	328	62	Tr400x5	81,000	HM3180	MS3180

Bearing		ISO dimensions						Weight kg	Locking nut	Locking device
Type	Version	d1 mm	d	d3	B1 kN	B2 kN	G			
H 3280	OH	380	400	520	328	62	Tr400x5	87,000	HM3180	MS3184-80
H 3980		380	400	470	168	52	Tr400x5	35,000	HM3080	MS3080
H 3084		400	420	490	212	52	Tr420X5	43,700	HM3084	MS3084
H 3084	OH	400	420	490	212	52	Tr420X5	47,000	HM3084	MS3084
H 3184		400	420	540	304	70	Tr420X5	84,200	HM3184	MS3184
H 3184	OH	400	420	540	304	70	Tr420X5	80,000	HM3184	MS3184-80
H 3284	OH	400	420	540	352	70	Tr420X5	96,000	HM3184	MS3184
H 3284		400	420	540	352	70	Tr420X5	96,000	HM3184	MS3184-80
H 3984		400	420	490	168	52	Tr420X5	36,600	HM3084	MS3084
H 3088	OH	410	440	520	228	60	Tr440X5	65,200	HM3088	MS3088
H 3088		410	440	520	228	60	Tr440X5	65,000	HM3088	MS3092-88
H 3188		410	440	560	307	70	Tr440X5	104,000	HM3188	MS3188
H 3188	OH	410	440	560	307	70	Tr440X5	95,000	HM3188	MS3192-88
H 3288		410	440	560	361	70	Tr440X5	118,000	HM3188	MS3188
H 3288	OH	410	440	560	361	70	Tr440X5	117,000	HM3188	MS3192-88
H 3988	OH	410	440	520	189	60	Tr440x5	58,000	HM3088	MS3088
H 3092		430	460	540	234	60	Tr460X5	71,000	HM3092	MS3092
H 3092		430	460	540	234	60	Tr460X5	71,000	HM3092	MS3092-88
H 3192	OH	430	460	580	326	75	Tr460X5	116,000	HM3192	MS3192
H 3192		430	460	580	326	75	Tr460X5	119,000	HM3192	MS3192-88
H 3292		430	460	580	382	75	Tr460X5	134,000	HM3192	MS3192
H 3292	OH	430	460	580	382	75	Tr460X5	134,000	HM3192	MS3192-88
H 3992		430	460	540	189	60	Tr460x5	60,000	HM3092	MS3092



Adapter Sleeve

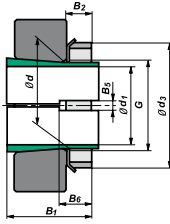

Bearing		ISO dimensions						Weight kg	Locking nut	Locking device
Type	Version	d1 mm	d	d3	B1 kN	B2 kN	G			
H 3096		450	480	560	237	60	Tr480X5	75,000	HM3096	MS30/96
H 3096	OH	450	480	560	237	60	Tr480X5	75,000	HM3096	MS30/500-96
H 3196		450	480	620	335	75	Tr480X5	135,000	HM3196	MS3196
H 3196	OH	450	480	620	335	75	Tr480X5	135,000	HM3196	MS3196
H 3296		450	480	620	397	75	Tr480X5	153,000	HM3196	MS3196
H 3296	OH	450	480	620	397	75	Tr480X5	153,000	HM3196	MS3196
H 3996		450	480	560	200	60	Tr480x5	66,000	HM3096	MS30/96
H 30/500		470	500	580	247	68	Tr500x5	82,000	HM30/500	MS30/500
H 30/500	OH	470	500	580	247	68	Tr500x5	82,000	HM30/500	MS30/500-96
H 31/500		470	500	630	356	80	Tr500x5	145,000	HM31/500	MS31/500
H 31/500	OH	470	500	630	356	80	Tr500x5	145,000	HM31/500	MS31/500
H 32/500		470	500	630	428	80	Tr500x5	166,000	HM31/500	MS31/500
H 32/500	OH	470	500	630	428	80	Tr500x5	170,000	HM31/500	MS31/500
H 39/500		470	500	580	208	68	Tr500x5	74,300	HM30/500	MS30/500
H 30/530		500	530	630	265	68	Tr530x6	105,000	HM30/530	MS30/530
H 30/530	OH	500	530	630	265	68	Tr530x6	105,000	HM30/530	MS30/600-530
H 31/530		500	530	670	364	80	Tr530x6	161,000	HM31/530	MS31/530
H 32/530		500	530	670	447	80	Tr530x6	192,000	HM31/530	MS31/530
H 39/530		500	530	630	216	68	Tr530x6	87,900	HM30/530	MS30/530
H 39/530	OH	500	530	630	216	68	Tr530x6	87,900	HM30/530	MS30/600-530
H 30/560		530	560	650	282	75	Tr560x6	112,000	HM30/560	MS30/560
H 30/560	OH	530	560	650	282	75	Tr560x6	112,000	HM30/560	MS30/560
H 31/560		530	560	710	377	85	Tr560x6	185,000	HM31/560	MS31/560
H 32/560		530	560	710	462	85	Tr560x6	219,000	HM31/560	MS31/560

Bearing		ISO dimensions						Weight kg	Locking nut	Locking device
Type	Version	d1 mm	d	d3	B1 kN	B2 kN	G			
H 39/560		530	560	650	227	75	Tr560x6	95,000	HM30/560	MS30/560
H 39/560	OH	530	560	650	227	75	Tr560x6	95,000	HM30/560	MS30/560
H 30/600		560	600	700	289	75	Tr600x6	147,000	HM30/600	MS30/600
H 30/600	OH	560	600	700	289	75	Tr600x6	147,000	HM30/600	MS30/600-530
H 31/600		560	600	750	399	85	Tr600x6	234,000	HM31/600	MS31/600
H 32/600		560	600	750	487	85	Tr600x6	278,000	HM31/600	MS31/600
H 39/600		560	600	700	239	75	Tr600x6	127,000	HM30/600	MS30/600
H 39/600	OH	560	600	700	239	75	Tr600x6	127,000	HM30/600	MS30/600-530
H 30/630		600	630	730	301	75	Tr630x6	138,000	HM30/630	MS30/630
H 30/630	OH	600	630	730	301	75	Tr630x6	138,000	HM30/630	MS30/630
H 31/630		600	630	800	424	95	Tr630x6	254,000	HM31/630	MS31/630
H 32/630		600	630	800	521	95	Tr630x6	300,000	HM31/630	MS31/630
H 39/630		600	630	730	254	75	Tr630x6	120,000	HM30/630	MS30/630
H 39/630	OH	600	630	730	254	75	Tr630x6	124,000	HM30/630	MS30/630
H 30/670		630	670	780	324	80	Tr670x6	191,000	HM30/670	MS30/670
H 30/670	OH	630	670	780	324	80	Tr670x6	190,000	HM30/670	MS30/670
H 31/670		630	670	850	456	106	Tr670x6	340,000	HM31/670	MS31/670
H 32/670		630	670	850	558	106	Tr670x6	401,000	HM31/670	MS31/670
H 39/670		630	670	780	264	80	Tr670x6	163,000	HM30/670	MS30/670
H 39/670	OH	630	670	780	264	80	Tr670x6	162,000	HM30/670	MS30/670
H 30/710		670	710	830	342	90	Tr710x7	223,000	HM30/710	MS30/710
H 30/710	OH	670	710	830	342	90	Tr710x7	228,000	HM30/710	MS30/710
H 31/710		670	710	900	467	106	Tr710x7	378,000	HM31/710	MS31/710
H 32/710		670	710	900	572	106	Tr710x7	444,000	HM31/710	MS31/710



Adapter Sleeve

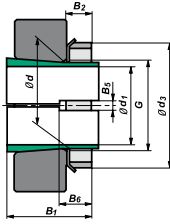

Bearing		ISO dimensions						Weight kg	Locking nut	Locking device
Type	Version	d1 mm	d	d3	B1 kN	B2 kN	G			
H 39/710		670	710	830	286	90	Tr710x7	196,000	HM30/710	MS30/710
H 39/710	OH	670	710	830	286	90	Tr710x7	183,000	HM30/710	MS30/710
H 30/750		710	750	870	356	90	Tr750x7	246,000	HM30/750	MS30/750
H 31/750		710	750	950	493	112	Tr750x7	451,000	HM31/750	MS31/750
H 32/750		710	750	950	603	112	Tr750x7	507,000	HM31/750	MS31/750
H 39/750		710	750	870	291	90	Tr750x7	211,000	HM30/750	MS30/750
H 30/800		750	800	920	366	90	Tr800x7	300,000	HM30/800	MS30/800
H 31/800		750	800	1000	505	112	Tr800x7	515,000	HM31/800	MS31/800
H 32/800		750	800	1000	618	112	Tr800x7	610,000	HM31/800	MS31/800
H 39/800		750	800	920	303	90	Tr800x7	259,000	HM30/800	MS30/800

Withdrawal Sleeve

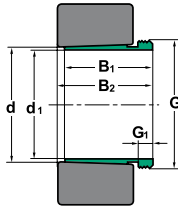

Withdrawal Sleeve		ISO dimensions						Weight kg	Dismounting nut	Hydraulic nut
Type	Version	d1 mm	d	B1	B2	G	G1			
AH 2308		35	40	40	43	M45x1,5	7	0,130	KM9	HMV9E
AH 308		35	40	29	32	M45x1,5	6	0,090	KM9	HMV9E
AH 2309		40	45	44	47	M50x1,5	7	0,160	KM10	HMV10E
AH 309		40	45	31	34	M50x1,5	6	0,110	KM10	HMV10E
AH 2310		45	50	50	53	M60x2	8	0,240	KM12	HMV12E
AH 310		45	50	35	38	M60x20	7	0,160	KM12	HMV12E
AH 2311		50	55	54	57	M65x2	9	0,290	KM13	HMV13E
AH 311		50	55	37	40	M65x2	7	0,190	KM13	HMV13E
AH 2312		55	60	57	60	M70x2	10	0,340	KM14	HMV14E
AH 312		55	60	40	43	M70x2	8	0,220	KM14	HMV14E
AH 2313		60	65	61	64	M75x2	12	0,400	KM15	HMV15E
AH 313		60	65	42	45	M75x2	8	0,250	KM15	HMV15E
AH 2314		65	70	65	69	M85x2	10	0,530	KM17	HMV17E
AH 314		65	70	43	47	M80x2	8	0,280	KM16	HMV16E
AH 2315		70	75	69	53	M90x2	12	0,610	KM18	HMV18E
AH 315		70	75	45	49	M85x2	8	0,310	KM17	HMV17E
AH 2316		75	80	72	76	M95x2	12	0,670	KM19	HMV19E
AH 316		75	80	48	52	M90x2	8	0,370	KM18	HMV18E
AH 2317		80	85	75	79	M100x2	13	0,750	KM20	HMV20E
AH 317		80	85	52	56	M100x2	9	0,480	KM20	HMV20E
AH 2318		85	90	80	84	M105x2	14	0,850	KM21	HMV21E
AH 318		85	90	53	57	M105x2	9	0,520	KM21	HMV21E
AH 2319		90	95	85	89	M110x2	15	0,980	KM22	HMV22E
AH 319		90	95	57	61	M110x2	10	0,590	KM22	HMV22E



Withdrawal Sleeve

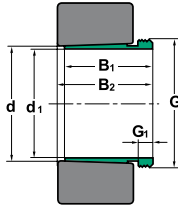

Withdrawal Sleeve		ISO dimensions						Weight kg	Dismounting nut	Hydraulic nut
Type	Version	d1 mm	d	B1	B2	G	G1			
AH 2320		95	100	90	94	M120x2	15	1,230	KM24	HMV24E
AH 320		95	100	59	63	M115x2	10	0,660	KM23	HMV23E
AH 2322		100	110	98	102	M130x2	16	2,110	KM26	HMV26E
AH 3122		100	110	68	72	M125x2	11	1,280	KM25	HMV25E
AH 322		100	110	63	67	M130x2	12	1,260	KM26	HMV26E
AH 24122		105	110	82	91	M115x2	13	0,710	KM23	HMV23E
AH 2324		110	120	105	109	M140x2	17	2,470	KM28	HMV28E
AH 3024		110	120	60	64	M130x2	13	1,150	KM26	HMV26E
AH 3124		110	120	75	79	M140x2	12	1,670	KM28	HMV28E
AH 24024		115	120	73	82	M125x2	13	0,700	KM25	HMV25E
AH 24124		115	120	93	102	M130x2	13	1,000	KM26	HMV26E
AH 2326		120	130	115	119	M150x2	19	3,020	KM30	HMV30E
AH 3026		120	130	67	71	M140x2	14	1,410	KM28	HMV28E
AH 3126		120	130	78	82	M150x2	12	1,870	KM30	HMV30E
AH 24026		125	130	83	93	M135x2	14	0,880	KM27	HMV27E
AH 24126		125	130	94	104	M140x2	14	1,150	KM28	HMV28E
AH 2328		130	140	125	130	M160x3	20	3,600	KM32	HMV32E
AH 3028		130	140	68	73	M150x2	14	1,550	KM30	HMV30E
AH 3128		130	140	83	88	M160x3	14	2,210	KM32	HMV32E
AH 24028		135	140	83	93	M145x2	14	0,950	KM29	HMV29E
AH 24128		135	140	99	109	M150x2	14	1,300	KM30	HMV30E
AH 2330		140	150	135	140	M170x3	24	4,220	KM34	HMV34E
AH 3030		140	150	72	5	M160x3	15	1,760	KM32	HMV32E
AH 3130		140	150	96	101	M170x3	15	2,700	KM34	HMV34E

Withdrawal Sleeve		ISO dimensions						Weight kg	Dismounting nut	Hydraulic nut
Type	Version	d1 mm	d	B1	B2	G	G1			
AH 24030		145	150	90	101	M155x3	15	1,050	KM31	HMV31E
AH 24130		145	150	115	126	M160x3	15	1,550	KM32	HMV32E
AH 2332		150	160	140	146	M180x3	24	4,720	KM36	HMV36E
AH 24032		150	160	95	106	M170x3	15	2,300	KM34	HMV34E
AH 24132		150	160	124	135	M170x3	15	3,000	KM34	HMV34E
AH 3032		150	160	77	82	M170x3	16	2,060	KM34	HMV34E
AH 3132		150	160	103	108	M180x3	16	3,210	KM36	HMV36E
AH 3232		150	160	124	130	M180x3	20	4,080	KM36	HMV36E
AH 2334		160	170	146	152	M190x3	24	5,250	KM38	HMV38E
AH 24034		160	170	106	117	M180x3	16	2,700	KM36	HMV36E
AH 24134		160	170	125	136	M180x3	16	3,250	KM36	HMV36E
AH 3034		160	170	85	90	M180x3	17	2,430	KM36	HMV36E
AH 3134		160	170	104	109	M190x3	16	3,400	KM38	HMV38E
AH 3136		160	180	116	122	M200x3	19	4,220	KM40	HMV40E
AH 3234		160	170	134	140	M190x3	24	4,800	KM38	HMV38E
AH 2236		170	180	105	110	M200x3	17	3,730	KM40	HMV40E
AH 2336		170	180	154	160	M200x3	26	5,830	KM40	HMV40E
AH 2336	OH	170	180	154	160	M200x3	26	6,050	KM40	HMV40E
AH 24036		170	180	116	127	M190x3	16	3,200	KM38	HMV38E
AH 24136		170	180	134	145	M190x3	16	3,750	KM38	HMV38E
AH 3036		170	180	92	98	M190x3	17	2,810	KM38	HMV38E
AH 3036		170	180	92	98	M190x3	17	2,800	KM38	HMV38E
AH 3036	OH	170	180	92	98	M190x3	17	2,800	KM38	HMV38E
AH 3136	OH	170	180	116	122	M200x3	19	3,900	KM38	HMV38E



Withdrawal Sleeve

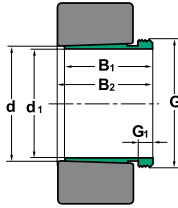

Withdrawal Sleeve		ISO dimensions						Weight kg	Dismounting nut	Hydraulic nut
Type	Version	d1 mm	d	B1	B2	G	G1			
AH 3236		170	180	140	146	M200x3	24	5,320	KM40	HMV40E
AH 3236	OH	170	180	140	146	M200x3	24	4,850	KM38	HMV38E
AH 2238		180	190	112	117	TR210x4	18	4,250	HM42T	HMV42E
AH 2338		180	190	160	167	TR210x4	26	6,630	HM42T	HMV42E
AH 2338	OH	180	190	160	167	TR210x4	26	6,700	HM42T	HMV42E
AH 24038		180	190	118	131	M200x3	18	3,550	KM40	HMV40E
AH 24138		180	190	146	159	M200x3	18	4,450	KM40	HMV40E
AH 3038		180	190	96	102	TR205x4	18	3,320	HML41T	HMV41E
AH 3038		180	190	96	102	M205X3	18	3,300	KM40	HMV40E
AH 3038	OH	180	190	96	102	M205x3	18	3,300	KM40	HMV40E
AH 3138		180	190	125	131	TR210x4	20	4,890	HM42T	HMV42E
AH 3138	OH	180	190	125	131	TR210x4	20	4,500	KM40	HMV40E
AH 3238		180	190	145	152	TR210x4	25	5,900	KM42T	HMV42E
AH 3238	OH	180	190	145	152	TR210x4	25	5,900	KM40	HMV40E
AH 2240		190	200	118	123	TR220x4	19	4,680	HM44T	HMV44E
AH 2340		190	200	170	177	TR220x4	30	7,540	HM44T	HMV44E
AH 2340	OH	190	200	170	177	TR220x4	30	7,600	HM44T	HMV44E
AH 24040		190	200	127	140	TR210x4	18	4,000	HM42T	HMV42E
AH 24140	OH	190	200	158	171	TR210x4	18	5,050	HM42T	HMV42E
AH 3040		190	200	102	108	TR215x4	19	3,800	HML43T	HMV43E
AH 3040	OH	190	200	102	108	TR215x4	19	3,700	HM42T	HMV42E
AH 3140		190	200	134	140	TR220x4	21	5,490	HM44T	HMV44E
AH 3140	OH	190	200	134	140	TR220x4	21	5,650	HM3044	HMV44E
AH 3240		190	200	153	160	TR220x4	25	6,680	HM44T	HMV44E

Withdrawal Sleeve		ISO dimensions						Weight kg	Dismounting nut	Hydraulic nut
Type	Version	d1 mm	d	B1	B2	G	G1			
AH 3240	OH	190	200	153	160	TR220x4	25	6,600	HM3044	HMV44E
AH 2244		200	220	130	136	TR240x4	20	9,100	HM48T	HMV48E
AH 2344		200	220	181	189	TR240x4	30	13,500	HM48T	HMV48E
AH 2344	OH	200	220	181	189	TR240x4	30	13,500	HM48T	HMV48E
AH 24144	OH	200	220	170	184	TR230x4	20	10,500	HM46T	HMV46E
AH 3044		200	220	111	117	TR235x4	20	7,400	HML47T	HMV47E
AH 3044	OH	200	220	111	117	TR235X4	20	7,300	HM46T	HMV46E
AH 3044		200	220	111	117	TR235X4	20	7,300	HM46T	HMV46E
AH 3144		200	220	145	151	TR240x4	23	10,400	HM48T	HMV48E
AH 3144	OH	200	220	145	151	TR240x4	23	9,300	HM3048	HMV48E
AH 2248	OH	220	240	144	150	TR260x4	21	11,100	HM52T	HMV52E
AH 2248		220	240	144	150	TR260x4	21	11,500	HM3052	HMV52E
AH 2348		220	240	189	197	TR260x4	30	15,500	HM52T	HMV52E
AH 2348	OH	220	240	189	197	TR260x4	30	14,000	HM52T	HMV52E
AH 3048		220	240	116	123	TR260x4	21	8,750	HM52T	HMV52E
AH 3048	OH	220	240	116	123	TR260x4	21	7,950	HM3052	HMV52E
AH 3048		220	240	116	123	TR260x4	21	7,950	HM3052	HMV52E
AH 3148		220	240	154	161	TR260x4	25	12,000	HM52T	HMV52E
AH 3148	OH	220	240	154	161	TR260x4	25	12,000	HM3052	HMV52E
AH 2252	OH	240	260	155	161	TR290x4	23	14,000	HM58T	HMV58E
AH 2252		240	260	155	161	TR290x4	23	12,500	HM58T	HMV58E
AH 2352	OH	240	260	205	213	TR290x4	30	19,600	HM58T	HMV58E
AH 2352		240	260	205	219	TR290x4	30	17,500	HM58T	HMV58E
AH 3052		240	260	128	135	TR280x4	23	10,700	HM56T	HMV56E



Withdrawal Sleeve

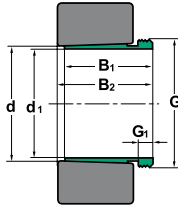

Withdrawal Sleeve		ISO dimensions						Weight kg	Dismounting nut	Hydraulic nut
Type	Version	d1 mm	d	B1	B2	G	G1			
AH 3052		240	260	128	135	TR280x4	23	9,600	HM3056	HMV56E
AH 3052	H	240	260	128	135	TR280x4	23	9,600	HM3056	HMV56E
AH 3052	OH	240	260	128	135	TR280x4	23	9,600	HM3056	HMV56E
AH 3152		240	260	172	179	TR290x4	26	16,200	HM58T	HMV58E
AH 3152	OH	240	260	172	179	TR290x4	26	15,500	HM3056	HMV56E
AH 2256		260	280	155	163	TR310x5	24	15,200	HM62T	HMV62E
AH 2256	OH	260	280	155	163	TR300x4	24	15,000	HM3160	HMV60E
AH 2356		260	280	212	220	TR310x5	30	17,100	HM3160	HMV60E
AH 2356	OH	260	280	212	220	TR310x5	30	19,500	HM62T	HMV62E
AH 24156	OH	260	280	202	219	TR300x4	22	16,3	HM 60 T	HMV 60
AH 3056		260	280	131	139	TR300x4	24	12,000	HM3060	HMV60E
AH 3056	OH	260	280	131	139	TR300x4	24	11,000	HM3060	HMV60E
AH 3156		260	280	175	183	TR310x5	28	17,500	HM62T	HMV62E
AH 3156	OH	260	280	175	183	TR310x5	28	17,000	HM3160	HMV60E
AH 2260		280	300	170	178	TR330X5	26	18,100	HM66T	HMV66E
AH 2260	OH	280	300	170	178	TR330X5	26	18,000	HM3164	HMV64E
AH 3060		280	300	145	153	TR320x5	26	14,400	HM3064	HMV64E
AH 3060		280	300	145	153	TR320X5	26	13,000	HM3064	HMV64E
AH 3060	OH	280	300	145	153	TR320X5	26	13,000	HM3064	HMV64E
AH 3160		280	300	192	200	TR330X5	30	20,800	HM66T	HMV66E
AH 3160	OH	280	300	192	200	TR330X5	30	20,500	HM3164	HMV64E
AH 3260		280	300	228	236	TR330X5	34	26,000	HM66T	HMV66E
AH 3260	OH	280	300	228	236	TR330X5	34	23,500	HM3164	HMV64E
AH 2264		300	320	180	190	TR350X5	27	20,200	HM70T	HMV70E

Withdrawal Sleeve		ISO dimensions						Weight kg	Dismounting nut	Hydraulic nut
Type	Version	d1 mm	d	B1	B2	G	G1			
AH 2264	OH	300	320	180	190	TR350X5	27	20,000	HM3168	HMV68E
AH 3064		300	320	149	157	TR345x5	27	16,000	HML69T	HMV69E
AH 3064		300	320	149	157	TR345X5	27	17,000	HM3068	HMV68E
AH 3064	OH	300	320	149	157	TR345X5	27	17,000	HM3068	HMV68E
AH 3164		300	320	209	217	TR350X5	31	24,500	HM70T	HMV70E
AH 3164	OH	300	320	209	217	TR350X5	31	24,500	HM3168	HMV68E
AH 3264	OH	300	320	246	254	TR350X5	36	30,600	HM70T	HMV70E
AH 3264		300	320	246	254	TR350X5	36	27,500	HM3168	HMV68E
AH 3068		320	340	162	171	TR365x5	28	19,500	HML73T	HMV73E
AH 3068	OH	320	340	162	171	TR365X5	28	19,000	HM3072	HMV72E
AH 3068		320	340	162	171	TR365X5	28	19,000	HM3072	HMV72E
AH 3168		320	340	225	234	TR370X5	33	29,000	HM74T	HMV74E
AH 3168	OH	320	340	225	234	TR370X5	33	28,500	HM3172	HMV72E
AH 3268		320	340	264	273	TR370X5	38	35,400	HM74T	HMV74E
AH 3268	OH	320	340	264	273	TR370X5	38	32,000	HM3172	HMV72E
AH 24168	OH	320	340	269	288	TR360x5	26	27,100	HM72T	HMV72E
AH 3072		340	360	167	176	TR385x5	30	21,000	HML77T	HMV77E
AH 3072		340	360	167	176	TR385X5	30	21,000	HM3076	HMV76E
AH 3072	OH	340	360	167	176	TR385X5	30	21,000	HM3076	HMV76E
AH 3172		340	360	229	238	TR400X5	33	30,500	HM3180	HMV80E
AH 3172	OH	340	360	229	238	TR400X5	35	30,500	HM3176	HMV76E
AH 3272	OH	340	360	274	283	TR400X5	40	41,500	HM3180	HMV80E
AH 3272		340	360	274	283	TR380X5	40	35,500	HM3176	HMV76E
AH 24172		340	360	269	289	TR380X5	26	30,800	HM3176	HMV76E



Withdrawal Sleeve

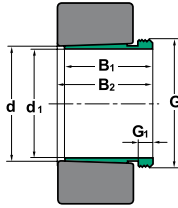

Withdrawal Sleeve		ISO dimensions						Weight kg	Dismounting nut	Hydraulic nut
Type	Version	d1 mm	d	B1	B2	G	G1			
AH 3076		360	380	170	180	TR410x5	31	23,200	HML82T	HMV82E
AH 3076		360	380	170	180	TR410X5	31	22,500	HM3080	HMV80E
AH 3076	OH	360	380	170	180	TR410X5	31	22,500	HM3080	HMV80E
AH 3176		360	380	232	242	TR420X5	36	35,700	HM3184	HMV84E
AH 3176	OH	360	380	232	242	TR420X5	36	33,000	HM3180	HMV80E
AH 3276		360	380	284	294	TR420X5	42	45,600	HM3184	HMV84E
AH 3276	OH	360	380	284	294	TR420X5	42	42,000	HM3180	HMV80E
AH 3080		380	400	183	193	TR430x5	33	27,300	HML86T	HMV86E
AH 3080		380	400	183	193	TR430X5	33	26,000	HM3080	HMV84E
AH 3080	OH	380	400	183	193	TR430X5	33	26,000	HM3080	HMV84E
AH 3180		380	400	240	250	TR440X5	38	39,500	HM3188	HMV88E
AH 3180	OH	380	400	240	250	TR440X5	38	36,000	HM3184	HMV84E
AH 3280		380	400	302	312	TR440X5	44	51,700	HM3188	HMV88E
AH 3280	OH	380	400	302	312	TR440X5	44	48,000	HM3184	HMV84E
AH 3084		400	420	186	196	TR450x5	34	29,000	HML90T	HMV90E
AH 3084		400	420	186	196	TR450X5	34	28,000	HM3088	HMV88E
AH 3084	OH	400	420	186	196	TR450X5	34	28,000	HM3088	HMV88E
AH 3184		400	420	266	276	TR460X5	40	27,900	HM3088	HMV88E
AH 3184	OH	400	420	266	276	TR460X5	40	43,000	HM3188	HMV88E
AH 3284		400	420	321	331	TR460X5	46	46,500	HM3192	HMV92E
AH 3284	OH	400	420	321	331	TR440X5	46	54,500	HM3188	HMV88E
AH 3088		420	440	194	205	TR470X5	35	31,000	HM3092	HMV92E
AH 3088	OH	420	440	194	205	TR470X5	35	31,000	HM3092	HMV92E
AH 3188		420	440	270	281	TR480X5	42	49,800	HM3196	HMV96E

Withdrawal Sleeve		ISO dimensions						Weight kg	Dismounting nut	Hydraulic nut
Type	Version	d1 mm	d	B1	B2	G	G1			
AH 3188	OH	420	440	270	281	TR480X5	42	46,000	HM3192	HMV92E
AH 3288		420	440	330	341	TR460X5	48	64,500	HM3192	HMV92E
AH 3288	OH	420	440	330	341	TR460X5	48	64,500	HM3192	HMV92E
AH 3092		440	460	202	213	TR490X5	37	34,000	HM3096	HMV96E
AH 3092	OH	440	460	202	213	TR490X5	37	34,000	HM3096	HMV96E
AH 3192		440	460	285	296	TR510X6	43	51,500	HM3196	HMV96E
AH 3192	OH	440	460	285	296	TR510X6	43	51,500	HM3196	HMV96E
AH 3292		440	460	349	360	TR480X5	50	80,000	HM3196	HMV96E
AH 3292	OH	440	460	349	360	TR480X5	50	80,000	HM3196	HMV96E
AH 3096		460	480	205	217	TR520X6	38	34,000	HM30/500	HMV100E
AH 3096	OH	460	480	205	217	TR520X6	38	34,000	HM30/500	HMV100E
AH 3196		460	480	295	307	TR530X6	45	63,000	HM31/500	HMV100E
AH 3196	OH	460	480	295	307	TR530X6	45	63,000	HM31/500	HMV100E
AH 3296		460	480	364	376	TR500X5	52	81,000	HM31/500	HMV100E
AH 3296	OH	460	480	364	376	TR500X5	52	81,000	HM31/500	HMV100E
AH 30/500		480	500	209	221	TR530X6	40	41,000	HM30/530	HMV106E
AH 30/500	OH	480	500	209	221	TR530X6	40	41,000	HM30/530	HMV106E
AH 31/500		480	500	313	325	TR530X6	47	66,500	HM31/530	HMV106E
AH 31/500	OH	480	500	313	325	TR530X6	47	66,500	HM31/530	HMV106E
AH 30/530		500	530	230	242	TR560X6	45	61,900	HM30/560	HMV112E
AH 30/530	OH	500	530	230	242	TR560X6	45	63,500	HM30/560	HMV112E
AH 31/530		500	530	325	337	TR560x6	53	93,400	HM31/560	
AH 32/530		500	530	412	424	TR580x6	57	133,000	HM116T	HMV16E
AH 30/560		530	560	240	252	TR600X6	45	73,500	HM30/600	HMV120E



Withdrawal Sleeve

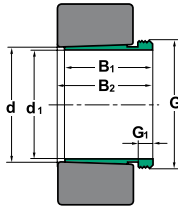

Withdrawal Sleeve		ISO dimensions						Weight kg	Dismounting nut	Hydraulic nut
Type	Version	d1 mm	d	B1	B2	G	G1			
AH 30/560	OH	530	560	240	252	TR600X6	45	73,500	HM30/600	HMV120E
AH 31/560		530	560	335	347	TR600x6	55	108,000	HM31/600	
AH 30/600		560	600	245	259	TR630X6	45	77,000	HM30/630	HMV126E
AH 30/600	OH	560	600	245	259	TR630X6	45	77,000	HM30/630	HMV126E
AH 30/630		600	630	258	272	TR670X6	46	89,700	HM30/670	HMV134E
AH 30/630	OH	600	630	258	272	TR670X6	46	88,500	HM30/670	HMV134E
AH 31/630		600	630	375	389	TR670x6	60	140,000	HM31/670	
AH 32/630		600	630	475	489	TR680x6	63	191,000	HM136T	HMV36E
AH 30/670		630	670	280	294	TR710X7	50	127,000	HM30/710	HMV142E
AH 30/670	OH	630	370	280	294	TR710X7	50	125,000	HM30/710	HMV142E
AH 32/670		630	670	500	514	TR720x7	62	256,000	HM144T	HMV44E
AH 30/710		670	710	286	302	TR750X7	50	138,000	HM30/750	HMV150E
AH 30/710	OH	670	710	286	302	TR750X7	50	138,000	HM30/750	HMV150E
AH 32/710		670	710	500	516	TR760x7	65	282,000	HM31/750	
AH 30/750		710	750	300	316	TR800x7	50	159,000	HM30/800	
AH 31/750		710	750	425	441	TR800x7	60	238,000	HM31/800	
AH 32/750		710	750	540	556	TR800x7	65	320,000	HM31/800	
AH 30/800		750	800	308	326	TR850x7	50	204,000	HM30/850	
AH 31/800		750	800	438	456	TR850x7	63	305,000	HM31/850	
AH 32/800		750	800	550	568	TR850x7	67	401,000	HM31/850	
AH 30/850		800	850	325	343	TR900x7	53	230,000	HM30/900	
AH 31/850		800	850	462	480	TR900x7	62	345,000	HM31/900	
AH 32/850		800	850	585	603	TR900x7	70	461,000	HM31/900	
AH 30/900		850	900	335	355	TR950x8	55	253,000	HM30/950	

Withdrawal Sleeve		ISO dimensions						Weight kg	Dismounting nut	Hydraulic nut
Type	Version	d1 mm	d	B1	B2	G	G1			
AH 31/900		850	900	475	495	TR950x8	63	379,000	HM31/950	
AH 32/900		850	900	585	605	TR950x8	70	489,000	HM31/950	
AH 30/950		900	950	355	375	TR1000x8	55	285,000	HM30/1000	
AH 31/950		900	950	500	520	TR1000x8	62	426,000	HM31/1000	
AH 32/950		900	950	600	620	TR1000x8	70	533,000	HM31/1000	





TAPERED ROLLER BEARINGS

Dimensions in accordance with ISO 355-2007

Tapered roller bearings are designed to take radial and thrust loads from one direction. They consist of the inner race (cone), with cage guided rollers, and the outer race (cup). The track has the same profile as the tapered rollers. The extension of the contact lines meet at a common point on the bearing axis of rotation. The cone and cup are separable. By using two bearings as opposed mountings, they can carry thrust loadings in both directions.

Single row tapered roller bearings can be supplied matched in “DB” or “DF” arrangement. These matched bearings are manufactured so that, when mounted opposite each other, the pair should have an established initial axial clearance and a uniform distribution of the loading. Matched bearings are used when the load carrying capacity of a single bearing is insufficient, or when the thrust loads have to be carried at a certain axial clearance in both directions.

Axial clearance

The axial clearance of single tapered roller bearings is adjusted on assembly.

With matched bearings, as with double and 4 row bearings, axial clearance is achieved by the addition of spacer rings ground to give the required clearance.

Radial clearances for double and four row tapered roller bearings are shown in the technical section. The radial clearance is transformed into axial clearance by the following relation:

$$\text{Axial clearance} = \frac{\text{Radial clearance}}{2 \tan \alpha}$$

where:

α = contact angle between rollers and the outer ring raceway



TAPERED ROLLER BEARINGS

Basic types and design variants

Single row

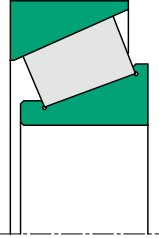

Matched

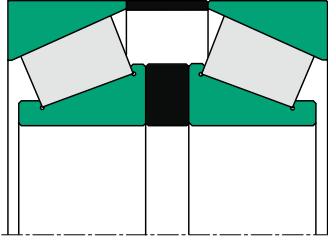

DF

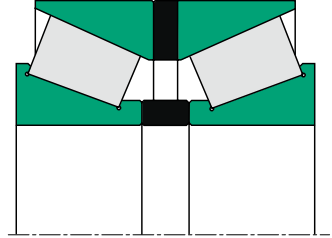

DB

Double row

Four row

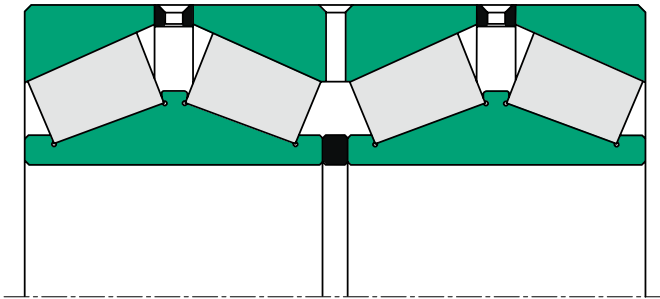

Tapered Roller Bearings

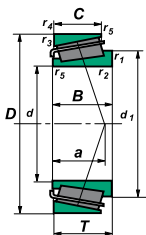

Bearing		ISO dimensions			Load ratings		Speed limits		Weight kg	Dimensions					Calculation factors			
Type	Vers.	d mm	D	T	C kN	Co kN	Grease r/min	Oil r/min		B	C	r1,2	r3,4	r5	a	e	Y	Y0
30202		15	35	11,75	15,8	14,4			0,053	11	10,0	0,6	0,6					
30302		15	42	14,25	23,9	21,6	9000	13000	0,09	13	11,0	1	1	0,3	9,00	0,28	2,1	1,1
30203		17	40	13,25	21,2	21,3	9000	13000	0,08	12	11,0	1	1	0,3	10,00	0,35	1,7	0,9
30303		17	47	15,25	29,7	27,2	8500	12000	0,13	14	12,0	1	1	0,3	10,00	0,28	2,1	1,1
32004		20	42	15	26,3	30	8500	12000	0,097	15	12,0	0,6	0,6	0,3	10,00	0,37	1,6	0,9
30204		20	47	15,25	28,2	30,6	8000	11000	0,12	14	12,0	1	1	0,3	11,00	0,35	1,7	0,9
30304		20	52	16,25	34,7	33,2	8000	11000	0,17	15	13,0	1,5	1,5	0,6	11,00	0,3	2	1,1
32204		20	47	19,25	37	40,6			0,161	18	15,0	1	1					
32304		20	52	22,25	44,6	46,3	7500	10000	0,221	21	18,0	1,5	1,5	0,6	14,00	0,3	2	1,1
30205		25	52	16,25	29,4	22,54	7500	10000	0,15	15	13,0	1	1	0,3	12,00	0,37	1,6	0,9
30305		25	62	18,25	49,2	48,1	6700	9000	0,25	17	15,0	1,5	1,5	0,6	13,00	0,3	2	1,1
31305	A	25	62	18,25	40,7	46,1	5600	7500	0,255	17	13,0	1,5	1,5	0,6	20,00	0,83	0,7	0,4
32005		25	47	15	28	34,1	7900	11000	0,112	15	11,5	0,6	0,6	0,3	11,60	0,43	1,39	0,77
32205		25	52	19,25	43	48	7500	10000	0,184	18	16,0	1	1	0,3	16,00	0,33	1,8	1
32305		25	62	25,25	64,6	68,8	6000	8000	0,36	24	20,0	1,5	1,5	0,6	15,00	0,3	2	1,1
33005		25	47	17	32,5	42,5			0,131	17	14,0	0,6	0,6					
33205		25	52	22	47,1	55,8			0,215	22	18,0	1	1					
30206		30	62	17,25	45,4	50,5	6300	8500	0,22	16	14,0	1	1	0,3	14,00	0,37	1,6	0,9
30306		30	72	20,75	61,7	63,1	5600	7500	0,38	19	16,0	1,5	1,5	0,6	15,00	0,31	1,9	1,1
31306		30	72	20,75	52,5	60,3	5000	6700	0,39	19	14,0	1,5	1,5	0,6	22,00	0,83	0,7	0,4
32006		30	55	17	38	48,9	6700	9000	0,017	17	13,0	1	1	0,3	13,00	0,43	1,4	0,8
32206		30	62	21,25	54,3	63,7	6300	8500	0,28	20	17,0	1	1	0,3	15,00	0,37	1,6	0,9
32306		30	72	28,75	85,5	96,4	5300	7000	0,55	27	23,0	1,5	1,5	0,6	18,00	0,31	1,9	1,1
30207		35	72	18,25	56,8	63,5	5300	7000	0,32	17	15,0	1,5	1,5	0,6	15,00	0,37	1,6	0,9



Tapered Roller Bearings

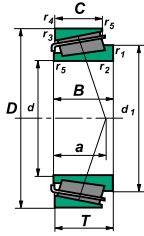

Bearing		ISO dimensions			Load ratings		Speed limits		Weight kg	Dimensions					Calculation factors			
Type	Vers.	d mm	D	T	C kN	Co kN	Grease r/min	Oil r/min		B	C	r1,2	r3,4	r5	a	e	Y	Y0
30307		35	80	22,75	78,8	82,6	5000	6700	0,52	21	18,0	2	1,5	0,6	16,00	0,31	1,9	1,1
31307		35	80	22,75	67,9	76,3	4500	6000	0,52	21	15,0	2	1,5	0,6	25,00	0,83	0,7	0,4
32007		35	62	18	35,9	52,4	6000	8000	0,22	18	14,0	1	1	0,3	15,00	0,46	1,3	0,7
32007		35	62	18	42	56	6000	8000	0,22	18	14,0	1	1	0,3	15,00	0,46	1,3	0,7
32207		35	72	24,25	74	89,5	5300	7000	0,42	23	19,0	1,5	1,5	0,6	17	0,37	1,6	0,9
33207		35	72	28	87,9	107	5700	7500										
32307		35	80	32,75	103,6	118,3	4800	6300	0,73	31	25,0	2	1,5	0,6	20,00	0,31	1,9	1,1
30208		40	80	19,75	63	74	4800	6300	0,42	18	16,0	1,5	1,5	0,6	16,00	0,37	1,6	0,9
30308		40	90	25,25	95,2	107,5	4500	6000	0,7	23	20,0	2	1,5	0,6	19,00	0,35	1,7	0,9
31308		40	90	25,25	81,4	96,4	4000	5300	0,685	23	17,0	2	1,5	0,6	28,00	0,83	0,7	0,4
32008		40	68	19	47	67,3	5300	7000	0,27	19	14,5	1	1	0,3	15,00	0,37	1,6	0,9
32008		40	68	19	48,8	65,6	5300	7000	0,27	19	14,5	1	1	0,3	15,00	0,37	1,6	0,9
32208		40	80	24,75	77,9	97,2	4800	6300	0,51	23	19,0	1,5	1,5	0,6	19	0,37	1,6	0,9
32308		40	90	35,25	120,8	147,1	4000	5300	0,993	33	27,0	2	1,5	0,6	23,00	0,35	1,7	0,9
30209		45	85	20,75	71,3	83,8	4500	6000	0,47	19	16,0	1,5	1,5	0,6	18,00	0,4	1,5	0,8
30309		45	100	27,25	114,05	129,8	4000	5300	0,92	25	22,0	2	1,5	0,6	21,00	0,35	1,7	0,9
31309		45	100	27,25	95,6	113,8	3400	4500	0,915	25	18,0	2	1,5	0,6	31	0,83	0,7	0,4
32009		45	75	20	57	82,2	4800	6300	0,33	20	15,5	1	1	0,3	16,00	0,4	1,5	0,8
32009		45	75	20	59,6	80,1	4800	6300	0,33	20	15,5	1	1	0,3	16,00	0,4	1,5	0,8
32209		45	85	24,75	84,1	103	4500	6000	0,56	23	19,0	1,5	1,5	0,6	20,00	0,4	1,5	0,8
32309		45	100	38,25	145,3	189,4	3600	4800	1,25	36	30,0	2	1,5	0,6	25,00	0,35	1,7	0,9
33009		45	75	24														
33109		45	80	26	87,1	117,2			0,536	26	20,5	1,5	1,5					
33209		45	85	32	109,5	145,1			0,771	32	25,0	2	2					

Bearing		ISO dimensions			Load ratings		Speed limits		Weight kg	Dimensions						Calculation factors		
Type	Vers.	d mm	D	T	C kN	Co kN	Grease r/min	Oil r/min		B	C	r1,2	r3,4	r5	a	e	Y	Y0
30210		50	90	21,75	73,3	92,1	4300	5600	0,53	20	17,0	1,5	1,5	0,6	19,00	0,43	1,4	0,8
30310		50	110	29,25	130,1	157,1	3600	4800	1,19	27	23,0	2,5	2	0,6	23	0,35	1,7	0,9
31310		50	110	29,25	108	128,25	3200	4300	1,16	27	19,0	2,5	2	0,6	34	0,83	0,7	0,4
32010		50	80	20	60	88	4500	6000	0,36	20	15,5	1	1	0,3	18	0,43	1,4	0,8
32010		50	80	20	58,5	88,5	4500	6000	0,36	20	15,5	1	1	0,3	18	0,43	1,4	0,8
32210		50	90	24,75	86,7	107,6	4300	5600	0,6	23	19,0	1,5	1,5	0,6	21,00	0,43	1,4	0,8
32310		50	110	42,25	177,5	236,1	3200	4300	1,830	40	33,0	2,5	2	0,6	27	0,35	1,7	0,9
33010		50	80	24	74,2	111,8	4600	6100										
33110		50	85	26	89,5	126,2	4400	5900	0,595	26	20,0	1,5	1,5		20,00	0,4	1,5	0,8
33210		50	90	32														
30211		55	100	22,75	94,6	112,8	3800	5000	0,69	21	18,0	2	1,5	0,6	20,00	0,4	1,5	0,8
30311		55	120	31,5	153,3	187,6	3200	4300	1,53	29	25,0	2,5	2	0,6	24	0,35	1,7	0,9
31311		55	120	31,5	129,9	158	2800	3800	1,49	29	21,0	2,5	2	0,6	37	0,83	0,7	0,4
32011		55	90	23	77	117	4000	5300	0,54	23	17,5	1,5	1,5	0,6	20	0,4	1,5	0,8
32011		55	90	23	79,7	115,6	4000	5300	0,54	23	17,5	1,5	1,5	0,6	20	0,4	1,5	0,8
32211		55	100	26,75	112,7	141,5	3600	4900	0,83	25	21,0	2	1,5	0,5	22,83	0,4	1,48	0,81
32311		55	120	45,5	212,7	271,3	3000	4000	2,21	43	35,0	2,5	2	0,6	29	0,35	1,7	0,9
33111		55	95	30	116,5	162,4	4000	5300										
30212		60	110	23,75	103,3	130	3400	4500	0,86	22	19,0	2	1,5	0,6	22,00	0,4	1,5	0,8
30312		60	130	33,5	171,4	210	3000	4000	1,90	31	26,0	3	2,5	1	26	0,35	1,7	0,9
31312		60	130	33,5	145,4	176,8	2600	3600	1,83	31	22,0	3	2,5	1	39	0,83	0,7	0,4
32012		60	95	23	78,5	119	3800	5000	0,58	23	17,5	1,5	1,5	0,6	21	0,43	1,4	0,8
32012		60	95	23	83,8	121,5	3800	5000	0,58	23	17,5	1,5	1,5	0,6	21	0,43	1,4	0,8
32212		60	110	29,75	132,8	179,6	3400	4500	1,10	28	24,0	2	1,5	0,6	24	0,4	1,5	0,8



Tapered Roller Bearings

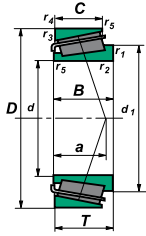

Bearing		ISO dimensions			Load ratings		Speed limits		Weight kg	Dimensions					Calculation factors			
Type	Vers.	d mm	D	T	C kN	Co kN	Grease r/min	Oil r/min		B	C	r1,2	r3,4	r5	a	e	Y	Y0
32312		60	130	48,5	226,7	303	2600	3600	2,80	46	37,0	3	2,5	1	31	0,35	1,7	0,9
33112		60	100	30	123,5	179	3700	5000										
33212		60	110	38	165,8	231,4	3000	4000	1,50	38	29,0	2	1,5	0,6	28	0,4	1,48	0,82
30213		65	120	24,75	120,6	152,6	3000	4000	1,10	23	20,0	2	1,5	0,6	23	0,4	1,5	0,8
30313		65	140	36	195,9	241,7	2600	3600	2,30	33	28,0	3	2,5	1	28	0,35	1,7	0,9
31313		65	140	36	165,7	202,6	2200	3200	2,25	33	23,0	3	2,5	1	42	0,83	0,7	0,4
32013		65	100	23	80,6	123	3400	4500	0,62	23	17,5	1,5	1,5	0,6	22	0,46	1,3	0,7
32213		65	120	32,75	160,9	221,7	3000	4000	1,48	31	27,0	2	1,5	0,6	27	0,4	1,5	0,8
32313		65	140	51	256	322	2400	3400	3,49	48	39,0	3	2,5	1	33	0,35	1,7	0,9
33013		65	100	27	100,5	162,7	3600	4800										
33113		65	110	34	153,6	224,6	3400	4600	1,3	34	26,5	1,5	1,5					
33213		65	120	41	202,2	281,6	3100	4200	1,99	41	32,0	2	1,5	0,5	29,50	0,39	1,53	0,84
30214		70	125	26,25	138,3	173,7	3000	4000	1,22	24	21,0	2	1,5	0,6	25	0,43	1,4	0,8
30314		70	150	38	219	271,7	2400	3400	3,00	35	30,0	3	2,5	1	29	0,35	1,7	0,9
32014		70	110	25	95,6	143	3200	4300	0,83	25	19,0	1,5	1,5	0,6	23	0,43	1,4	0,8
32214		70	125	33,25	168,5	237,1	2800	3800	1,56	31	27,0	2	1,5	0,6	28	0,43	1,4	0,8
32314		70	150	54	297	381	2200	3200	4,10	51	42,0	3	2,5	1	36	0,35	1,7	0,9
33014		70	110	31	127	204	3200	4200	1,07									
33114		70	120	37	172	250	4000	5300	1,70									
33214		70	125	41	204	290	2900	3900	2,10	41	32,0	2	1,5	0,8	30,7	0,41	1,47	0,81
30215		75	130	27,25	138,4	185,4	2800	3800	1,33	25	22,0	2	1,5	0,6	27	0,43	1,4	0,8
30315		75	160	40	252,8	318,8	2600	3600	3,40	37	31,0	3	2,5	1	31	0,35	1,7	0,9
31315		75	160	40	240	245	3200	4300	3,50	37	26,0	3	2,5	1	48	0,83	0,7	0,4
32015		75	115	25	103,1	160,2	3000	4000	0,88	25	19,0	1,5	1,5	0,6	25	0,46	1,3	0,7

Bearing		ISO dimensions			Load ratings		Speed limits		Weight kg	Dimensions						Calculation factors		
Type	Vers.	d mm	D	T	C kN	Co kN	Grease r/min	Oil r/min		B	C	r1,2	r3,4	r5	a	e	Y	Y0
32015		75	115	25	97,3	149	3000	4000	0,88	25	19,0	1,5	1,5	0,6	25	0,46	1,3	0,7
32215		75	130	33,25	170,3	242,1	2600	3600	2,62	31	27,0	2	1,5	0,6	29	0,43	1,4	0,8
32315		75	160	58	345	480	2200	3000	5,30	55	45,0	3	2,5	1	38	0,35	1,7	0,9
33015		75	115	31	129	212	3000	4000	1,13									
33115		75	125	37	176	265	3800	5000	1,80									
33215		75	130	41	208	298	2700	3600	2,20									
30216		80	140	28,25	167,7	212,9	2400	3400	1,59	26	22,0	2,5	2	0,6	28	0,43	1,4	0,8
30316		80	170	42,5	278,8	352,5	2000	3000	4,00	39	33,0	3	2,5	1	33	0,35	1,7	0,9
31316		80	170	42,5	260	265	3000	4000	4,05	39	27,0	3	2,5	1	52	0,83	0,7	0,4
32016		80	125	29	141	220	2600	3600	1,25	29	22,0	1,5	1,5	0,6	27	0,43	1,4	0,8
32216		80	140	35,25	198,1	279	2400	3400	2,00	33	28,0	2,5	2	0,6	30	0,43	1,4	0,8
32316		80	170	61,5	387,9	543,1	2100	2800	6,10	58	48,0	3	2,5	1	41	0,35	1,7	0,9
33016		80	125	36	173	284	2800	3700	1,60									
33116		80	130	37	179	280	3600	4800	1,9	37	29,0	2	1,5					
33216		80	140	46	250	365	2500	3400	2,92									
30217		85	150	30,5	177,6	236,8	2200	3200	2,00	28	24,0	2,5	2	0,6	30	0,43	1,4	0,8
30317		85	180	44,5	305	388	2100	2900	4,96	41	34,0	4	3	1	35	0,35	1,7	0,9
31317		85	180	44,5	242	285	2600	3800	4,60	41	28,0	4	3					
32017		85	130	29	142	224	2600	3500	1,35	29	22,0	1,5	1,5	0,6	28	0,44	1,4	0,8
32217		85	150	38,5	227	324	2200	3200	2,70	36	30,0	2,5	2	0,6	33	0,43	1,4	0,8
32317		85	180	63,5	421	592	1900	2700	7,10	60	49,0	4	3	1	42	0,35	1,7	0,9
33017		85	130	36	176	296	2600	3500	1,70									
33117		85	140	41	220	340	3400	4500	2,45									
30318		90	190	46,5	342	441	2000	2700	5,80	43	36,0	4	3	1	36	0,35	1,7	0,9



Tapered Roller Bearings

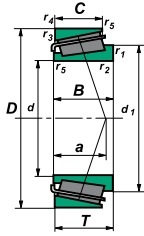

Bearing		ISO dimensions			Load ratings		Speed limits		Weight kg	Dimensions					Calculation factors			
Type	Vers.	d mm	D	T	C kN	Co kN	Grease r/min	Oil r/min		B	C	r1,2	r3,4	r5	a	e	Y	Y0
31318		90	190	46,5	264	315	2400	3400	5,90	43	30,0	4	3	1	57	0,83	0,7	0,4
32018		90	140	32	168	270	2500	3300	1,79	32	24,0	2	1,5	0,6	30	0,43	1,4	0,8
32218		90	160	42,5	270	396	2000	3000	3,40	40	34,0	2,5	2	0,6	36	0,43	1,4	0,8
32318	A	90	190	67,5	468	625	2000	2700	8,79	64	53,0	4	3	1,5	46,2	0,35	1,74	0,96
33018		90	140	39	215	360	2500	3300	2,18									
33118		90	150	45	251	390	3000	4300	3,10	45	35,0	2,5	2		35	0,4	1,5	0,8
30219		95	170	34,5	227	309	2100	2800	3,04	32	34,2	3	2,5	1,2	27	0,43	1,4	0,8
30319		95	200	49,5	369	478	1900	2500	6,80	45	38,0	4	3	1	39	0,35	1,7	0,9
32019		95	145	32	171	280	2300	3100	1,83	32	24,0	2	1,5	0,6	31	0,44	1,4	0,8
31319		95	200	49,5	292	355	2400	3400	3,95									
32219		95	170	45,5	303	448	1900	2800	4,30	43	37,0	3	2,5	1	39	0,43	1,4	0,8
32319		95	200	71,5	516	737	1700	2300	10,10	67	55,0	4	3	1	47	0,35	1,7	0,9
33019		95	145	39	219	375	2300	3100	2,270	39	32,5	2	1,5	0,6	27,6	0,28	2,16	0,4
30220		100	180	37	254	350	2000	2700	3,72	34	29,0	3	2,5	1	35	0,43	1,4	0,8
30320		100	215	51,5	406	526	1800	2400	8,22	47	39,0	4	3	1	40	0,35	1,7	0,9
31320		100	215	56,5	430	465	2400	3000										
32020		100	150	32	170	280	2200	3000	1,91	32	24,0	2	1,5	0,6	32	0,46	1,3	0,7
32220		100	180	49	341	512	1800	2600	5,10	46	39,0	3	2,5	1	41	0,43	1,4	0,8
33020		100	150	39	224	390	2200	3000	2,37	39	32,5	0,5	1,5					
33120		100	165	52	325	607	2800	4100	5,33									
32320		100	215	77,5	600	872	1600	2100	13,01	73	60,0	4	3	1	53	0,35	1,7	0,9
30221		105	190	39	285	399	1900	2500	4,38	36	30,0	3	2,5	1	37	0,43	1,4	0,8
30321		105	225	53,5	433	562	1700	2300	9,38									
32021		105	160	35	201	335	2100	2800	2,42	35	26,0	2,5	2	0,6	34	0,44	1,4	0,8

Bearing		ISO dimensions			Load ratings		Speed limits		Weight kg	Dimensions						Calculation factors		
Type	Vers.	d mm	D	T	C kN	Co kN	Grease r/min	Oil r/min		B	C	r1,2	r3,4	r5	a	e	Y	Y0
32221	A	105	190	53	381	579	1700	2500	6,20	50	43,0	3	2,5	1	44	0,43	1,4	0,8
32321		105	225	81,5	660	915	1500	2000	15,00	77	63,0	4	4	3	54	0,35	1,7	0,96
33021		105	160	43	245	420	2100	2800	3	43	34,0	2,5	2					
33121		105	175	56	360	607	2600	3800	5,33									
30222		110	200	41	315	444	1800	2400	5,21	38	32,0	3	2,5	1	39	0,43	1,4	0,8
30322		110	240	54,5	473	612	1600	2200	11,00	50	42,0	4	3	1	43	0,35	1,7	0,9
31322		110	240	63	457	585	1900	2800	12,00									
32022		110	170	38	245,7	403,4	2100	2800	3,02	38	36,6	2,5	2	1	36,6	0,43	1,4	0,8
32222		110	200	56	432	666	1700	2400	7,10	53	46,0	3	2,5	1	46	0,43	1,4	0,8
32322		110	240	84,5	627	830	1400	1900	17,00	80	65,0	4	3	1	55	0,35	1,7	0,9
33022		110	170	47	288	500	2000	2700	3,80									
33122		110	180	56	369	630	2600	3400	5,55									
30224		120	215	43,5	337	483	1700	2200	6,20	40	34,0	3	2,5	1	43	0,43	1,4	0,8
30324		120	260	59,5	561	710	1500	2000	14,00	55	46,0	4	3	1	47	0,35	1,7	0,9
31324		120	260	68	539	695	1700	2400	15,50	62	42,0							
32024		120	180	38	320	545	1800	2500	4,96	38	29,0	2,5	2	0,6	39	0,46	1,3	0,7
32224		120	215	61,5	468	695	1600	2200	9,15	58	50,0	3	2,5	1	51	0,43	1,4	0,8
32324		120	260	90,5	845	1190	1300	1800	22,40	86	69,0	4	3	1	60	0,35	1,7	0,96
33024		120	180	48	292	540	2600	3400	4,20									
33124		120	200	62	462	785	2400	3200	7,73									
30226		130	230	43,75	366	521	1500	2000	6,94	40	34,0	4	3	1	45	0,43	1,4	0,8
30326	X	130	280	63,75	627	800	1300	1800	17,00	58	49,0	5	4	1,5	51	0,35	1,7	0,9
31326		130	280	72	605	780	1600	2400	18,50	66	44,0	5	4	1,5	87	0,83	0,7	0,4
32026		130	200	45	326	550	1700	2200	4,93	45	34,0	2,5	2	1	43,3	0,43	1,38	0,76



Tapered Roller Bearings

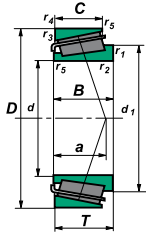

Bearing		ISO dimensions			Load ratings		Speed limits		Weight kg	Dimensions					Calculation factors			
Type	Vers.	d mm	D	T	C kN	Co kN	Grease r/min	Oil r/min		B	C	r1,2	r3,4	r5	a	e	Y	Y0
32226		130	230	67,75	550	830	1500	2000	11,50	64	54,0	4	3	1	56	0,43	1,4	0,8
32326		130	280	98,75	858	1180	1100	1600	30,50	93	78,0	5	4	1,5	66	0,35	1,7	0,9
30228	A	140	250	45,75	405	540	1400	1900	8,80	42	36,0	4	3	1	47	0,44	1,4	0,76
30328	A	140	300	67,75	670	945	1200	1700	21,20	62	53,0	5	5			0,35	1,7	0,96
32028		140	210	45	330	580	1600	2100	5,28	45	34,0	2,5	2	0,6	46	0,46	1,3	0,7
32228		140	250	71,75	644	1000	1400	1900	14,50	68	58,0	4	3	1	60	0,43	1,4	0,8
32328	A	140	300	107,75	1090	1630	1200	1700	35,80	102	85,0	5	5	4	74	0,37	1,6	0,9
30230		150	270	49	451	646	1300	1700	10,80	45	38,0	4	3	1	50	0,43	1,4	0,8
30330		150	320	72	825	1060	1100	1600	28,50									
32030		150	225	48	370	655	1400	1900	6,37	48	36,0	3	2,5	1	49	0,46	1,3	0,7
32230		150	270	77	737	1140	1200	1700	17,50	73	60,0	4	3	1	64	0,43	1,4	0,8
32330		150	320	114	1170	1660	950	1400	46,00									
33030		150	225	59	457	865	2000	2600	8,15									
30232		160	290	52	512	739	1200	1600	13,30	48	40,0	4	3	1	54	0,43	1,4	0,8
30332		160	340	75	913	1180	1000	1500	29,00									
32032		160	240	51	435	790	1400	1800	7,80	51	38,0	3	2,5	1	52	0,46	1,3	0,7
32232		160	290	84	880	1400	1100	1600	25,50	80	67,0	4	3	1	70	0,43	1,4	0,8
32332	A	160	340	121	1400	2230	1000	1500	51,70	114	95,0	5	4		81	0,35	1,7	0,96
30234		170	310	57	591	866	1100	1500	16,60	52	43,0	5	4	1,5	58	0,43	1,4	0,8
30334		170	360	80	1020	1340	950	1400	35,00									
32034		170	260	57	500	895	1300	1700	10,50	57	43,0	3	2,5	1	56	0,44	1,4	0,8
32234		170	310	91	1010	1630	1000	1500	28,50	86	71,0	5	4	1,5	75	0,43	1,4	0,8
30236		180	320	57	610	912	1100	1400	17,30	52	43,0	5	4	1,5	61	0,46	1,3	0,7
32036		180	280	64	655	1210	1100	1500	14,50	64	48,0	3	2,5	1	59	0,43	1,4	0,8

Bearing		ISO dimensions			Load ratings		Speed limits		Weight kg	Dimensions						Calculation factors		
Type	Vers.	d mm	D	T	C kN	Co kN	Grease r/min	Oil r/min		B	C	r1,2	r3,4	r5	a	e	Y	Y0
32236	A	180	320	91	1020	1670	950	1400	32,30	86	71,0	5	5	4	78	0,45	1,3	0,73
30238		190	340	60	715	1000	1000	1300	20,80									
32038		190	290	64	655	1210	1100	1500	15,10	64	48,0	3	2,5	1	62	0,44	1,4	0,8
32238		190	340	97	1000	1670	1000	1300	33,30	92	75,0	5	4	1,5	81	0,43	1,4	0,8
32938		190	260	45	341	707	1100	1600	6,52	42	36,0	2,5	2	2	49	0,38	1,6	0,86
30240		200	360	64	780	1100	900	1300	25,40	58	48,0	5	5	4	70	0,44	1,4	0,76
32040		200	310	70	782	1470	1100	1470	19,30	70	53,0	3	2,5	1	66	0,43	1,4	0,8
32240		200	360	104	1350	2144	900	1300	42,60	98	82,0	5	5	4	84	0,41	1,5	0,81
32940		200	280	51	455	935	1000	1500	9,50	51	39,0	3	3	2,5	54	0,39	1,5	0,84
30244		220	400	72	975	1370	900	1300	36,80	65	54,0	5	5	4	77	0,42	1,4	0,79
32044		220	340	76	909	1690	960	1690	25,00	76	57,0	4	3	1	72	0,43	1,4	0,8
32244		220	400	114	1610	2770	900	1300	62,70	108	50,0	5	5	4	96	0,44	1,4	0,76
32944		220	300	51	471	978	1000	1400	10,00	48	41,0	3	2,5	1	56,1	0,37	1,6	0,88
32048		240	360	76	930	1760	870	1200	27,50	76	57,0	4	3	1	78	0,46	1,3	0,7
32248		240	440	127	1900	3300	700	950	82,50	120	100,0	5	5	4	105	0,43	1,4	0,8
32948		240	320	51	520	1065	850	1200	11,50	51	39,0	3	3	2,5	64	0,46	1,3	0,7
32052		260	400	87	912	1835	800	1100	40,00	87	65,0	5	4	1,5	84	0,43	1,4	0,8
32252		260	480	137	2160	3650	670	900	105,00	130	105,0	6	6	5	113	0,43	1,4	0,77
30352		260	540	114	2015	2730	670	900	113,00	102	85,0	6	6	6	92	0,32	1,9	1,04
32952		260	360	63,5	700	1470	800	1100	19,20	60	52,0	3	3	2,5	60	0,3	2	1,09
32056		280	420	87	1194	1840	750	1000	39,60	87	65,0	5	5	4	83	0,37	1,6	0,89
32956		280	380	63,5	746	1579	800	1100	19,7	60	52,0	3	3	2,5	64	0,32	1,9	1,03
32960		300	420	76	1019	2200	700	950	30,20	72	62,0	4	4	3	67	0,28	2,1	1,17



Tapered Roller Bearings

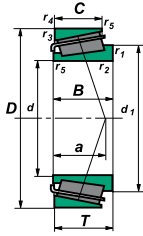

Bearing		ISO dimensions			Load ratings		Speed limits		Weight kg	Dimensions					Calculation factors			
Type	Vers.	d mm	D	T	C kN	Co kN	Grease r/min	Oil r/min		B	C	r1,2	r3,4	r5	a	e	Y	Y0
32060		300	460	100	1516	2740	670	900	56,60	100	74,0	5	5	4	97	0,43	1,4	0,8
30660		300	540	149	2680	4700	600	800	142,00	140	115,0	6	6	5	126	0,43	1,4	0,8
32964		320	440	76	1046	2317	650	900	34,50	76	57,0	4	4	3	84	0,43	1,4	0,8
32064		320	480	100	1500	2940	630	850	62,70	100	74,0	5	5	4	104	0,46	1,3	0,72
30664		320	620	141	2780	4600	520	680	183,00	125	107,0	7,5	7,5	7,5	154	0,6	1	0,6
32968		340	460	76	1000	2350	500	830	36,50	76	57,0	4	4	3	90	0,44	1,35	0,8
32972		360	480	76	970	2220	500	630	38,50	76	57,0	4	4	4	97	0,46	1,3	0,72
30672		360	680	165	3620	6250	480	600	262,00	150	125,0	7,5	7,5	7,5	172	0,6	1	0,6
30680		400	750	130	2660	4180	320	430	222,00	115	77,0	6	6	6	189	0,7	0,86	0,47
30692		460	860	210	5590	10100	350	470	512,00	190	160,0	7,5	7,5	7,5	218	0,57	1,05	0,6
30696		480	950	240	6980	12500	310	420	761,00	225	174,0	9,5	9,5	9,5	230	0,54	1,1	0,6
306/560		560	1080	265	8910	15700	180	270	1063,00	235	208,0	9,5	9,5	9,5	241	0,43	1,4	0,8
329/630		630	850	132	3080	7150	360	450	200,00	132	95,0	6	6	6	168	0,46	1,3	0,72
306/630		630	920	134	3410	7100	320	430	286,00	128	94,0	7,5	7,5	7,5	166	0,43	1,4	0,78
306/680		680	1000	190	5580	12500	250	350	486,00	188	140,0	6	6	6	200	0,43	1,4	0,8
319/710		710	950	114	2860	6900	260	360	210,00	106	80,0	6	6	6	175	0,46	1,3	0,72
306/1000		1000	1420	210	8100	18000	160	230	966,00	195	150,0	7,5	7,5	7,5	278	0,46	1,3	0,72





THRUST BALL BEARINGS

Dimensions in accordance with ISO 104-2002

Thrust ball bearings are available in single and double acting versions. They sustain axial loads only, and therefore should not be used where radial loads are present.

The thrust loading should not drop below a minimum axial load, maintaining contact between the balls and the track when centrifugal forces are present.

They are manufactured in the following series: 511, 512, 513, 514, 522, 523 and 524.

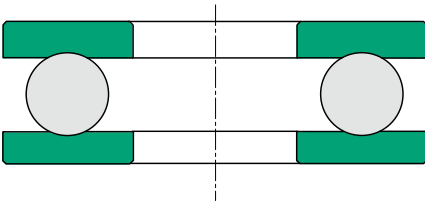

511, 512, 513, 514

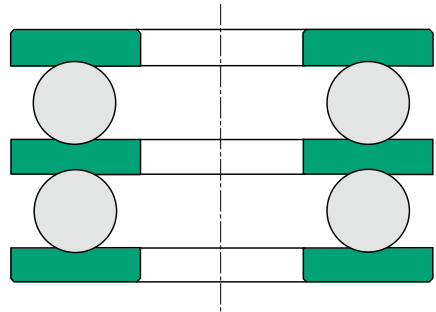

522, 523, 524



THRUST BALL BEARINGS

Single-acting thrust ball bearings

Single acting thrust ball bearings are used to carry thrust loads in only one direction and cannot carry radial loads. They are made up of a shaft washer, a flat housing washer and a ball and cage assembly. These bearings can be easily mounted by separately fitting each washer.

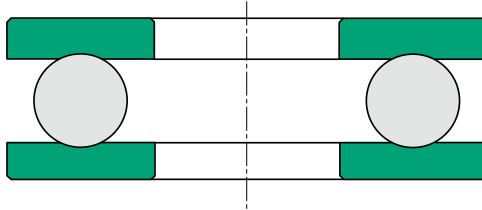

Double-acting thrust ball bearing

These bearings can carry thrust loadings in both directions. They are fitted with an extra thrust washer and two ball and cage assemblies.

See technical section for further information.

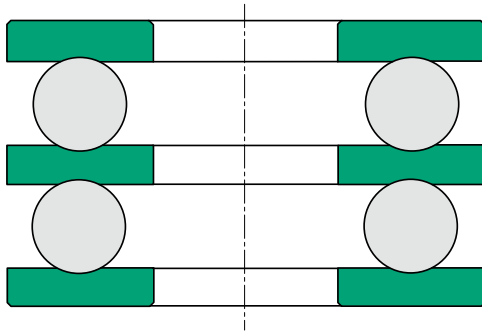

Minimum load

The thrust ball bearing requires a minimum axial load, so that the rolling elements maintain rolling contact and sliding is minimized. "F_{am}" can be obtained from formula:

$$F_{am} = M \left[\frac{n \text{ Max}}{1000} \right]^2 \text{ [N]}$$

where:

F _{am}	=	minimum thrust load (N)
M	=	Factor for minimum load
n	=	speed in RPM

Single Row Thrust Ball Bearings

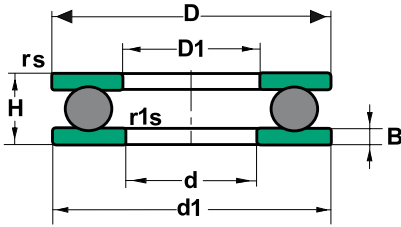

Bearing		ISO dimensions			Load ratings		Speed limits		Weight	Dimensions		
Type	Version	d mm	D	H	C kN	Co kN	Grease r/min	Oil r/min	kg	D1	d1	r1,2 min
51100		10	24	9	10,0	14,0	6300	9000	0,02	11	24	0,3
51101		12	26	9	10,2	15,2	6000	8500	0,02	13	26	0,3
51201		12	28	11	13,2	19,0	5300	7500	0,03	14	28	0,6
51102		15	28	9	10,5	16,8	5600	8000	0,02	16	28	0,3
51202		15	32	12	16,5	24,8	4800	6700	0,04	17	32	0,6
51103		17	30	9	10,8	18,2	5300	7500	0,02	18	30	0,5
51203		17	35	12	17,0	27,2	4500	6800	0,05	19	35	0,6
51104		20	35	10	14,2	24,5	4800	6700	0,04	21	35	0,3
51204		20	40	14	22,2	37,5	3800	5300	0,08	22	40	0,6
51105		25	42	11	15,2	30,2	4300	6000	0,06	26	42	1,0
51205		25	47	15	27,8	50,5	3400	4300	0,11	27	47	0,6
51305		25	52	18	35,5	61,5	3000	4300	0,17	27	52	1,0
51106		30	47	11	16,0	34,2	4000	5600	0,06	32	47	0,6
51206		30	52	16	28,0	54,2	3200	4500	0,13	32	52	0,6
51306		30	60	21	42,8	78,5	2400	3600	0,26	32	60	1,0
51107		35	52	12	18,2	41,5	3800	5300	0,08	37	52	0,6
51207		35	62	18	39,2	78,2	2800	4000	0,21	37	62	1,0
51307		35	68	24	55,2	105,0	2000	3200	0,37	37	68	1,0
51108		40	60	13	26,8	62,8	3400	4800	0,11	42	60	0,6
51208		40	68	19	44,8	91,8	2400	3600	0,26	42	68	1,5
51308		40	78	26	69,2	135,0	1900	3000	0,53	42	78	1,0
51109		45	65	14	27,0	66,0	3200	4500	0,14	47	65	0,6
51209		45	73	20	47,8	105,0	2200	3400	0,30	47	73	1,0
51309		45	85	28	75,8	150,0	1700	2600	0,66	47	85	1,0

Single Row Thrust Ball Bearings

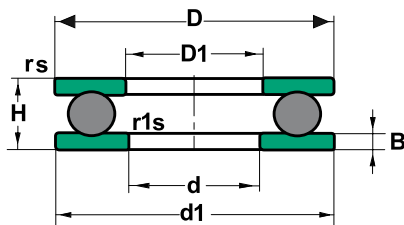

Bearing		ISO dimensions			Load ratings		Speed limits		Weight	Dimensions		
Type	Version	d mm	D	H	C kN	Co kN	Grease r/min	Oil r/min	kg	D1	d1	r1,2 min
51110		50	70	14	27,2	69,2	3000	4300	0,15	52	70	0,6
51210		50	78	22	48,5	112,0	2000	3200	0,37	52	78	1,0
51310		50	95	31		202,0	1600	2400	0,92	52	95	1,1
51111		55	78	16	33,8	89,2	2800	4000	0,22	57	78	1,0
51211		55	90	25	67,5	158,0	1900	3000	0,58	57	90	1,0
51311		55	105	35	115,0	242,0	1500	2200	1,28	57	105	1,1
51112		60	85	17	40,2	108,0	2600	3800	0,27	62	85	1,0
51212		60	95	26	73,5	178,0	1800	2800	0,66	62	95	1,0
51312		60	110	35	118,0	262,0	1400	2000	1,37	62	110	1,1
51113		65	90	18	40,5	112,0	2400	3600	0,31	67	90	1,0
51213		65	100	27	74,8	188,0	1700	2600	0,72	67	100	1,0
51313		65	115	36	115,0	262,0	1300	1900	1,18	67	115	1,1
51114		70	95	18	40,8	115,0	2200	3400	0,33	72	95	1,5
51214		70	105	27	73,5	188,0	1600	2400	0,75	72	105	1,0
51314		70	125	40	148,0	340,0	1200	1800	1,98	72	125	1,1
51115		75	100	19	48,2	140,0	2000	3200	0,38	77	100	1,0
51215		75	110	27	74,8	198,0	1500	2200	0,82	77	110	1,0
51315		75	135	44	162,0	380,0	1100	1700	2,58	77	135	1,5
51116		80	105	19	48,5	145,0	1900	3000	0,40	82	105	1,0
51216		80	115	28	83,8	222,0	1400	2000	0,90	82	115	1,0
51316		80	140	44	160,0	380,0	1000	1600	2,69	82	140	1,5
51117		85	110	19	49,2	150,0	1800	2800	0,42	87	110	1,0
51217		85	125	31	102,0	280,0	1300	1900	1,21	88	125	1,0
51317		85	150	49	208,0	495,0	950	1500	3,47	88	150	1,5

Bearing		ISO dimensions			Load ratings		Speed limits		Weight	Dimensions		
Type	Version	d mm	D	H	C kN	Co kN	Grease r/min	Oil r/min	kg	D1	d1	r1,2 mm
51118		90	120	22	65,0	200,0	1700	2600	0,65	92	120	1,0
51218		90	135	35	115,0	315,0	1200	1800	1,65	93	135	1,1
51318		90	155	50	205,0	495,0	900	1400	3,69	93	155	1,5
51120		100	135	25	85,0	268,0	1600	2400	0,95	102	135	1,0
51220		100	150	38	132,0	375,0	1100	1700	2,21	103	150	1,1
51320		100	170	55	235,0	595,0	800	1200	4,86	103	170	1,5
51122		110	145	25	87,0	288	2500	2200	1,03	112	145	1,0
51222		110	160	38	138,0	412	2000	1600	2,39	113	160	1,1
51224		120	170	39	135,0	412	950	1500	2,62	123	170	1,1
51226		130	190	45	188,0	575	900	1400	3,93	133	187	1,5
51226	M	130	190	45	212,0	620	950	1400	4,44	133	187	1,5
51128	M	140	180	31	107,0	377	1300	1800	0,90	142	178	2,0
51228	M	140	200	46	215,0	669	950	1400	2,00	143	197	4,5
51130	M	150	190	31	109,0	402	1200	1700	1,00	152	188	2,2
51230	M	150	215	50	257,0	795	900	1300	5,21	153	212	5,6
51330	M	150	250	80	377,0	1200	670	900	9,00	154	245	15,7
51430	M	150	300	120	668,0	2242	-	650	42,00	154	295	4,0
51132	M	160	200	31	112,0	427	1200	1700	1,00	162	198	2,3
51232	M	160	225	51	247,0	803	850	1200	3,20	163	222	6,5
51134	M	170	215	34	134,0	512	1100	1600	1,40	172	213	3,3
51234	M	170	240	55	269,0	874	800	1100	4,50	173	237	8,1
51334	M	170	280	87	463,0	1570	600	800	13,00	174	275	22,0
51136	M	180	225	34	135,0	528	1000	1500	1,50	183	222	3,4
51236	M	180	250	56	294,0	986	800	1100	5,00	183	247	8,7

Single Row Thrust Ball Bearings

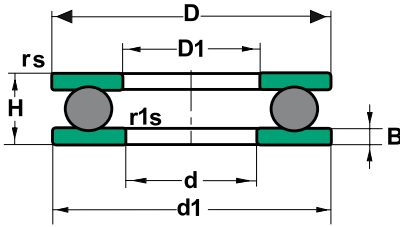

Bearing		ISO dimensions			Load ratings		Speed limits		Weight	Dimensions		
Type	Version	d mm	D	H	C kN	Co kN	Grease r/min	Oil r/min	kg	D1	d1	r1,2 min
51336	M	180	300	95	463,0	1580	560	750	28,10	184	295	3,0
51138	M	190	240	37	170,0	657	950	1400	2,40	193	237	4,0
51140	M	200	250	37	169,0	602	950	1400	2,40	203	247	4,2
51240	M	200	280	62	333,0	1207	750	1000	8,00	204	275	12,5
51144	M	220	270	37	177,0	739	900	1300	3,00	223	267	4,7
51244	M	220	300	63	342,0	1308	700	950	9,50	224	295	13,5
51148	M	240	300	45	230,0	91	850	1200	5,00	243	297	7,5
51248	M	240	340	78	463,0	1889	600	800	18,00	244	335	23,5
51152	M	260	320	45	236,0	984	750	1000	5,60	263	317	8,1
51252	M	260	360	79	473,0	1967	560	750	22,00	264	355	25,5
51156	M	280	350	53	337,0	1435	700	950	10,00	283	347	12,0
51256	M	280	380	80	506,0	2168	560	750	24,00	284	375	27,5
51160	M	300	380	62	400,0	1530	630	850	14,00	304	376	17,5
51260	M	300	420	95	625,0	2872	480	630	40,00	304	415	43,0
51164	M	320	400	63	390,0	1580	600	800	16,00	324	396	19,0

Double Rows Thrust Ball Bearings

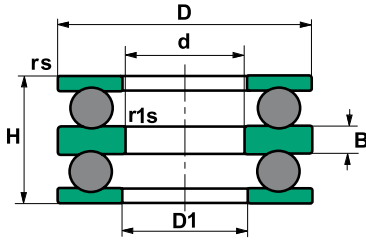

Bearing		ISO dimensions			Load ratings		Speed limits		Weight	Calculation factors			
Type	Version	d mm	D	H	C kN	Co kN	Grease r/min	Oil r/min	kg	D1	B	rs min	r1s min
52202		10	32	22	17	25	5000	6700	0,09	17	5	0,6	0,3
52204		15	40	26	22	38	4300	5600	0,15	22	6	0,6	0,3
52405		15	60	45	56	89	2600	3600	0,63	27	11	1,0	0,3
52205		20	47	28	28	50	3800	5000	0,23	27	7	0,6	0,3
52305		20	52	34	36	61	3200	4300	0,33	27	8	1,0	0,3
52406		20	70	52	73	126	2000	3000	1,00	32	12	1,0	0,6
52206		25	52	29	28	54	3600	4800	0,27	32	7	0,6	0,3
52306		25	60	38	43	79	2800	3800	0,49	32	9	1,0	0,3
52407		25	80	59	87	155	1800	2600	1,44	37	14	1,1	0,6
52207		30	62	34	41	84	3000	4000	0,42	37	8	1,0	0,3
52208		30	68	36	47	98	2800	3800	0,54	42	9	1,0	0,6
52307		30	68	44	56	105	2400	3400	0,71	37	10	1,0	0,3
52308		30	78	49	69	135	2000	3000	1,06	42	12	1,0	0,6
52408		30	90	65	113	205	1700	2400	2,08	42	15	1,1	0,6
52209		35	73	37	48	105	2600	3600	0,62	47	9	1,0	0,6
52309		35	85	52	81	163	1900	2800	1,29	47	12	1,0	0,6
52409		35	100	72	130	242	1600	2200	2,71	47	17	1,1	0,6
52210		40	78	39	49	111	2400	3400	0,71	52	9	1,0	0,6
52310		40	95	58	92	186	1800	2600	1,86	52	14	1,1	0,6
52410		40	110	78	148	283	1500	2000	3,56	52	18	1,5	0,6
52211		45	90	45	69	159	1900	2800	1,12	57	10	1,0	0,6
52311		45	105	64	119	246	1600	2200	2,51	57	15	1,1	0,6
52411		45	120	87	178	359	1300	1800	4,70	57	20	1,5	0,6
52212		50	95	46	74	179	1900	2800	1,25	62	10	1,0	0,6

Double Rows Thrust Ball Bearings

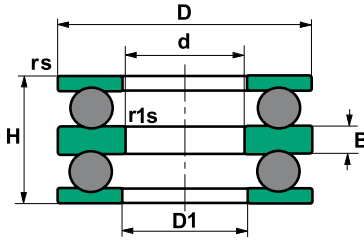

Bearing		ISO dimensions			Load ratings		Speed limits		Weight	Calculation factors			
Type	Version	d mm	D	H	C kN	Co kN	Grease r/min	Oil r/min	kg	D1	B	rs min	r1s min
52312		50	110	64	124	267	1600	2200	2,68	62	15	1,1	0,6
52412		50	130	93	201	397	1100	1600	6,33	62	21	1,5	0,6
52413		50	140	101	232	493	1000	1500	8,03	68	23	2,0	1,0
52213		55	100	47	75	189	1800	2600	1,36	67	10	1,0	0,6
52214		55	105	47	74	189	1800	2600	1,48	72	10	1,0	1,0
52313		55	115	65	128	287	1500	2000	2,90	67	15	1,1	0,6
52314		55	125	72	148	339	1400	1900	3,90	72	16	1,1	1,0
52215		60	110	47	77	209	1700	2400	1,57	77	10	1,0	1,0
52315		60	135	79	171	396	1200	1700	4,83	77	18	1,5	1,0
52216		65	115	48	79	218	1700	2400	1,69	82	10	1,0	1,0
52316		65	140	79	176	424	1200	1700	5,06	82	18	1,5	1,0
52217		70	125	55	92	251	1600	2200	2,34	88	12	1,0	1,0
52317		70	150	87	206	489	1100	1600	6,43	88	19	1,5	1,0
52218		75	135	62	117	326	1500	2000	3,22	93	14	1,1	1,0
52318		75	155	88	213	524	1000	1500	6,60	93	19	1,5	1,0
52420		80	210	150	368	983	700	950	26,60	103	33	2,0	1,0
52220		85	150	67	147	410	1300	1800	4,29	103	15	1,1	1,0
52320		85	170	97	236	596	950	1400	8,90	103	21	1,5	1,0
52222		95	160	67	148	431	1200	1700	4,68	113	15	1,1	1,0
52322		95	90	110	280	754	850	1200	13,80	113	24	2,0	1,0
52224		100	170	68	154	472	1100	1600	5,24	123	15	1,1	1,1
52324		100	210	123	325	931	800	1100	17,20	123	27	2,1	1,1
52226		110	190	80	203	622	950	1400	7,74	133	18	1,5	1,1
52228		120	200	81	215	669	950	1400	8,95	143	18	1,5	1,1

Bearing		ISO dimensions			Load ratings		Speed limits		Weight	Calculation factors			
Type	Version	d mm	D	H	C kN	Co kN	Grease r/min	Oil r/min	kg	D1	B	rs min	r1s min
52230		130	215	89	244	768	900	1300	10,60	153	20	1,5	1,1
52330		130	250	140	377	1200	670	900	27,10	154	31	2,1	1,1
52232		140	225	90	247	803	850	1200	12,20	163	20	1,5	1,1
62332		140	250	140	470	1570	630	850	26,20	154	31	2,1	1,1
52234		150	240	97	269	874	800	1100	15,20	173	21	1,5	1,1





SPHERICAL ROLLER THRUST BEARINGS

Dimensions in accordance with ISO 104-2002

These bearings are designed to accommodate heavy thrust loads. Due to raceways being inclined to the bearings axis, they can also accommodate radial loads up to a maximum of 55% of the thrust load and are suitable for taking high thrust loads at relatively high speed. Misalignment varies per series; figures are shown below.

Series	Misalignment
292	2°
293	2.5°
294	3°

The bearings are fitted with asymmetrical barrel-shaped rollers. Dimensions conform to ISO 104-2002. In general, lubrication of these bearings should be with oil except in certain exceptional cases. It is also essential that a minimum thrust load be present to avoid damage to the raceways by centrifugal forces (see formula below).

$$F_{a \text{ min}} = \frac{1.5 \text{ cor}}{1000} \text{ [kN]}$$

where:

$F_{a \text{ min}}$ = minimum thrust load [kN]

Cor = static capacity [kN]



Spherical Roller Thrust Bearings

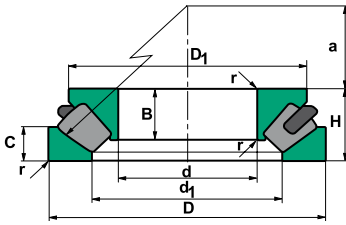

Bearing		ISO dimensions			Load ratings		Speed limits		Weight	Calculation factors					
Type	Version	d mm	D	H	C kN	Co kN	Grease r/min	Oil r/min	kg	d1	D1	B min	C min	a	r1,2 min
29412	EM	60	130	42	364,5	967,2	1650	2200	2,75	85,0	115	34	20,5	38	1,5
29413	EM	65	140	45	418,2	1126	1550	2200	3,41	91,5	125	36	21,9	42	2
29414	EM	70	150	48	467	1344	1450	2000	4,1	99,5	135	38,5	23,4	44	2
29415	EM	75	160	51	546	1522	1450	1800	4,98	106,0	140	40,5	25	47	2
29416	EM	80	170	54	610	1722	1450	1800	5,95	112,5	150	43,6	26	50	2,1
29317	EM	85	150	39	300	1050	1500	2000	2,87	110,0	135	31	19,4	50	1,5
29417	EM	85	180	58	653	1815	1200	1600	7,19	119,5	160	46	27,5	54	2,1
29318	EM	90	155	39	370	1139	1500	2000	3,06	115,5	140	31	19,8	52	1,5
29418	EM	90	190	60	747	2147	1200	1600	8,28	125,5	170	48,7	29,3	56	2,1
29320	EM	100	170	42	440	1400	1400	1800	3,91	127,5	155	32,5	21,2	58	1,5
29420	EM	100	210	67	883	2552	1000	1400	11,2	141,0	185	53	32,2	62	3
29322	EM	110	190	48	542	1740	1200	1600	5,67	141,5	175	37	23,9	64	2
29422	EM	110	230	73	1048	3079	900	1200	14,7	154,0	205	57	35,1	69	3
29324	EM	120	210	54	685	2230	1000	1400	7,96	155,0	190	41	27,2	70	2,1
29424	EM	120	250	78	1191	3566	900	1200	18,5	168,0	220	61	38,8	74	4
29326	EM	130	225	58	770	2520	900	1400	9,45	167,0	205	44,5	28,3	76	2,1
29426	EM	130	270	85	1382	4160	780	1100	23,6	181,0	240	66,5	41,1	81	4
29328	EM	140	240	60	868	2940	850	1200	11,2	178,0	220	46,5	29,6	82	2,1
29428	EM	140	280	85	1433	4436	780	1000	24,6	192,5	250	66,5	41,4	86	4
29330	EM	150	250	60	884	3065	850	1200	11,7	188,0	230	46	30	87	2,1
29430	EM	150	300	90	1624	5111	700	1000	29,6	205,0	270	70	44,3	92	4
29332	EM	160	270	67	1021	3486	800	1100	15,5	204,0	245	51	33	92	3
29432	EM	160	320	95	1750	5330	680	900	35,9	218,5	285	74	46,9	99	5
29234	EM	170	240	42	439	1760	1600	1600	5,54	199,0	225	32	20	92	1,5

Bearing		ISO dimensions			Load ratings		Speed limits		Weight	Calculation factors					
Type	Version	d mm	D	H	C kN	Co kN	Grease r/min	Oil r/min	kg	d1	D1	B min	C min	a	r1,2 min
29334	EM	170	280	67	1044	3644	800	1000	16,3	214,5	255	51	32,9	96	3
29434	EM	170	340	103	2062	6585	630	850	44	233,0	305	79,5	50,8	104	5
29236	EM	180	250	42	420	2010	750	1300	7,05	208,0	236	32	22	96	1,5
29336	EM	180	300	73	1244	4387		1000	20,7	227,5	275	55,2	35,8	103	3
29436	EM	180	360	109	2275	7317	1760	5500	52,2	247,5	320	84,5	52,5	110	5
29238	EM	190	270	48	518	2460		1300	7,95	220,0	255	36	25,4	102	2
29338	EM	190	320	78	1398	4955	580	760	25,5	240,0	295	59,5	39,2	110	4
29438	EM	190	380	115	2527	8205	750	800	61,4	260,5	340	88	56,3	117	5
29240	EM	200	280	48	546	2518		1300	9,08	230,0	263	39	24	108	2
29340	EM	200	340	85	1582	5566	650	800	32	253,5	310	64	42,7	116	4
29440	EM	200	400	122	2785	9070	550	760	73	275,0	360	93,5	59	122	5
29244	EM	220	300	48	694	2974		1200	9,84	249,5	285	36	25,4	117	2
29344	EM	220	360	85	1608	5822	650	800	34,5	275,0	330	64	42,6	125	4
29444	EM	220	420	122	2870	9634	500	680	74,2	275,0	360	93,5	59	122	6
29248	EM	240	340	60	977	4077		1000	17,1	278,0	320	44	31,7	130	2,1
29348	EM	240	380	85	1700	6412	630	800	36,3	297,0	350	64	42,1	135	4
29448	EM	240	440	122	2978	10298	500	630	83	316,0	400	93,5	60,1	142	6
29252	EM	260	360	60	1050	4598		1000	18,5	300,5	340	45,5	30,4	139	2,1
29352	EM	260	420	95	2110	8050	550	710	51,5	323,0	385	71,8	48,2	148	5
29452	EM	260	480	132	3200	12375	450	630	106	342,5	435	102	64,8	154	6
29256	EM	280	380	60	1050	4598		900	19,5	321,0	360	45	31	150	2,1
29356	EM	280	440	95	2220	8767	550	710	54	343,0	405	71,8	48	158	5
29456	EM	280	520	145	4131	14645	430	560	137	370,5	470	110	72,4	166	6
29260	EM	300	420	73	1466	6488		710	31	348,0	395	54,5	36,4	162	3



Spherical Roller Thrust Bearings

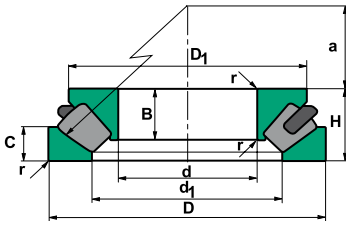

Bearing		ISO dimensions			Load ratings		Speed limits		Weight	Calculation factors					
Type	Version	d mm	D	H	C kN	Co kN	Grease r/min	Oil r/min	kg	d1	D1	B min	C min	a	r _{1,2} min
29360	EM	300	480	109	2682	10400	500	700	69,6	370,5	440	81	55,9	168	5
29460	EM	300	540	145	4250	15449	400	500	146	392,0	490	110	72,4	175	6
29264	EM	320	440	73	1521	6893		630	32,8	368,5	415	54	37,4	172	3
29364	EM	320	500	109	2833	11360	450	560	80	391,5	465	81	55,2	180	5
29464	EM	320	580	155	4917	18167	380	500	179	417,5	525	118,5	76,7	191	7,5
29268	EM	340	460	73	1570	7304		630	34,5	389,0	435	54,5	36,5	183	3
29368	EM	340	540	122	3373	13425	400	500	106	419,5	500	90,5	60,6	192	5
29468	EM	340	620	170	5504	20070	340	450	228	446,0	560	128	84,5	201	7,5
29272	EM	360	500	85	1989	9084		560	50,4	417,0	475	63	42,7	194	4
29372	EM	360	560	122	3442	13990		500	140	440,0	520	91	60,8	202	5
29472	EM	360	640	170	5682	21212		450	234	467,5	580	129	83,1	210	7,5
29276	EM	380	520	85	2002	9307		560	52,8	437,5	490	65	43,1	202	4
29376	EM	380	600	132	3962	16164		500	140	466,0	555	98,5	66,9	216	6
29476	EM	380	670	175	6025	22737		430	263	490,5	610	130	85,9	230	7,5
29280	EM	400	540	85	2065	9839		700	55,1	457,5	510	63,3	42,6	212	4
29380	EM	400	620	132	4040	16810		450	146	487,5	575	98	66,9	225	6
29480	EM	400	710	185	6757	25820		380	314	517,5	645	140	94	236	7,5
29284	EM	420	580	95	2536	12067		560	74,9	483,5	550	72	49,7	225	5
29384	EM	420	650	140	4434	18466		420	170	512,5	600	103,5	70,7	235	6
29484	EM	420	730	185	6969	27200		370	325	538,0	665	142	92,1	244	7,5
29288	EM	440	600	95	2618	12747		560	79	503,5	570	72	49,6	235	5
29388	EM	440	680	145	4757	20018		400	192	536,5	630	108	73,7	245	6
29488	EM	440	780	206	8073	31032		350	421	570,0	710	152	105	260	9,5
29292	EM	460	620	95	2644	13085		500	80,9	524,5	590	72	49,4	245	5

Bearing		ISO dimensions			Load ratings		Speed limits		Weight	Calculation factors					
Type	Version	d mm	D	H	C kN	Co kN	Grease r/min	Oil r/min	kg	d1	D1	B min	C min	a	r1,2 min
29392	EM	460	710	150	5205	22264		400	216	558,5	660	112	76,6	257	6
29492	EM	460	800	206	8325	32668		350	435	592,5	730	149	107	272	9,5
29296	EM	480	650	103	2982	14620		480	98	549,0	620	76,5	52,1	259	5
29396	EM	480	730	150	5214	22550		400	224	579,5	675	112	76	270	6
29496	EM	480	850	224	9419	36691		320	534,2	623,0	770	166,5	111,8	280	9,5
292/500	EM	500	670	103	3012	14987		450	101	569,5	640	76,5	52	268	5
293/500	EM	500	750	150	5322	23422		360	231	600,0	700	112	76,2	280	6
294/500	EM	500	870	224	9520	40000		320	559	643,0	790	170	109,1	290	9,5
292/530	EM	530	710	109	3356	16859		400	108	603,0	675	81	55,2	288	5
293/530	EM	530	800	160	6057	26973		320	270	639,5	745	119,5	81	295	7,5
294/530	EM	530	920	236	10703	42908		300	650	682,0	840	177	118,5	309	9,5
292/560	EM	560	750	115	3100	8600		350	140	640,0	715	84	56,8	302	5
293/560	EM	560	850	175	5790	29700		280	320						7,5
294/560	EM	560	980	250	10210	47800		250	740	890,0	727	92	120	328	12
292/600	EM	600	800	122	3420	20100		300	172	688,0	760	39	60	321	5
293/600	EM	600	900	180	6350	32600		250	368	731,0	870	61	87	335	7,5
294/600	EM	600	1030	258	12730	52273		200	880	766,0	940	200	128,7	347	12
292/630	EM	630	850	132	4770	24500		250	218	728,0	814,5	94	67,3	338	6
293/630	EM	630	950	190	7070	37000		200	438						9,5
294/630	EM	630	1090	280	13700	58200		200	1000						12
292/670	EM	670	900	104	4900	26000		380	225	773,0	855	93	74	364	6
293/670	EM	670	1000	200	7720	40300		150	501						9,5
292/710	EM	710	950	145	4840	29400		150	261						6
293/710	EM	710	1060	212	8570	45100		120	579						9,5



Spherical Roller Thrust Bearings

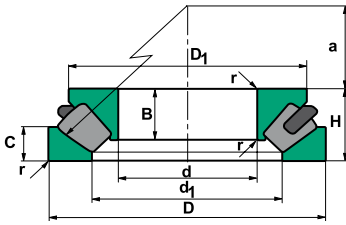

Bearing		ISO dimensions			Load ratings		Speed limits		Weight	Calculation factors					
Type	Version	d mm	D	H	C kN	Co kN	Grease r/min	Oil r/min	kg	d1	D1	B min	C min	a	r1,2 min
294/710	EM	710	1220	308	16800	71000		180	1500	1130	910	113	148,5	415	15
292/750	EM	750	1000	150	5180	31900		130	311	854,5	955	108	76	406	6
293/750	EM	750	1120	224	9370	50600		100	696						9,5
294/750	EM	750	1280	315	15000	76000		150	1536	972,0	1164	222	158	436	18
292/800	EM	800	1060	155	5620	35300		100	339	1010,0	907,5	50	80	426	7,5
293/800	EM	800	1180	230	10110	54900		80	780						9,5
292/850	EM	850	1120	160	6080	38900		80	389						7,5
292/900	EM	900	1180	170	6590	42000		60	444	1017,0	1129,5	122	86	477	7,5



OTHER PRODUCTS

The Rollway production program also includes:

- Slewing ring bearings
- Full complement cylindrical roller bearings
- Tandem thrust bearings
- Multi stage thrust bearings
- Cross roller bearings
- Screw down bearings

SI-Standard

Force

1 kN (kilonewton)	= 1000 N = 102 kp
1 kp	= 9.81 N

Pressure

1 bar = 10 N/cm	= 1.02 kp/cm ²
1 kp / cm ²	= 9.81 N/cm ² = 0.981 bar

Mechanical stress, surface pressure

1 N/mm ²	= 1 MPa (megapascal)
	= 0.102 kp/mm ²
1 kp /mm ²	= 9.81 N/mm ²

Torsional moment

1 Nm	= 0.102 kpm
1 kpm	= 9.81 Nm

Output

1 w	= 1 J7s = Nm/s
	= 0.102 kpm/s
1 kW	= 1.36 hp = 102kpm/s
1 hp	= 0.736 kW = 75 kpm/s
1 kpm/s	= 9.81 W

Kinematic viscosity

1 mm ² /s	= 1 cSt (centistokes)
----------------------	------------------------

CONVERSION TABLES

Millimeters to inches

1 mm = 0.0393701 inches

mm	inches	mm	inches	mm	inches	mm	inches
		.025	.00098	.050	.00197	.075	.00295
.001	.0004	.026	.00102	.051	.00201	.076	.00299
.002	.00008	.027	.00106	.052	.00205	.077	.00303
.003	.00012	.028	.00110	.053	.00209	.078	.00307
.004	.00016	.029	.00114	.054	.00213	.079	.00311
.005	.00020	.030	.00118	.055	.00217	.080	.00315
.006	.00024	.031	.00122	.056	.00220	.081	.00319
.007	.00028	.032	.00126	.057	.00224	.082	.00323
.008	.00032	.033	.00130	.058	.00228	.083	.00327
.009	.00035	.034	.00134	.059	.00232	.084	.00331
.010	.00039	.035	.00138	.060	.00236	.085	.00335
.011	.00043	.036	.00142	.061	.00240	.086	.00338
.012	.00047	.037	.00148	.062	.00244	.087	.00343
.013	.00051	.038	.00150	.063	.00248	.088	.00346
.014	.00065	.039	.00154	.064	.00252	.089	.00350
.015	.00059	.040	.00157	.065	.00256	.090	.00354
.016	.00063	.041	.00161	.066	.00260	.091	.00358
.017	.00067	.042	.00165	.067	.00264	.092	.00362
.018	.00071	.043	.00169	.068	.00268	.093	.00366
.019	.00075	.044	.00173	.069	.00272	.094	.00370
.020	.00079	.045	.00177	.070	.00276		
.021	.00083	.046	.00181	.071	.00280		
.022	.00087	.047	.00185	.072	.00283		
.023	.00091	.048	.00280	.073	.00287		
.024	.0009	.049	.00193	.074	.00291		

mm	0	10	20	30	40	50	60	70	80	90
0	0	.3970	.78740	1.18110	1.57480	1.96850	2.36220	2.75591	3.14961	3.54331
1	.03937	.43307	.82677	1.22047	1.61417	2.00787	2.40157	2.79528	3.18898	3.58268
2	.07874	.47244	.86814	1.25084	1.65354	2.04724	2.44004	2.83465	3.22835	3.62205
3	.11811	.51181	.90551	1.29921	1.69291	2.08661	2.48031	2.87402	3.26772	3.66142
4	.15748	.55118	.94488	1.33858	1.73228	2.12598	2.51969	2.91330	3.30700	3.70070
5	.19685	.59065	.98425	1.37795	1.77165	2.16535	2.55906	2.95276	3.34646	3.74010
6	.23622	.62992	1.02362	1.41732	1.81103	2.20472	2.59843	2.99218	3.38583	3.77053
7	.27559	.66929	1.06299	1.45669	1.85039	2.24409	2.63780	3.03150	3.42520	3.81800
8	.31408	.70866	1.10236	1.49608	1.88976	2.28346	2.67717	3.07087	3.46457	3.85827
9	.35343	.74803	1.14173	1.53543	1.92913	2.32282	2.71654	3.11024	3.50394	3.89764

CONVERSION TABLES

Inches to millimeters

1 inch = 25.4mm

inches	mm	inches	mm	inches	mm	inches	mm
.015625	.3969	.265625	6.7469	.515625	13.0969	.765625	19.4460
.03125	.7937	.28125	7.1437	.53125	13.4037	.78175	19.8437
.046875	1.1908	.296875	7.5406	.546875	13.8006	.796874	20.2406
.0625	1.5875	.3125	7.9375	.5625	14.2875	.8125	20.6379
.076125	1.9844	.328125	8.3344	.578125	14.6844	.828125	21.0344
.09075	2.3812	.34075	8.7312	.593748	15.0812	.84075	21.4312
.109075	2.7781	.359375	9.1281	.609375	15.4781	.850375	21.8281
.125	3.1750	.375	9.5250	.625	15.8750	.875	22.250
.140625	3.5719	.390625	9.9219	.640625	16.2719	.890626	22.6219
.15625	3.9687	.40625	10.3187	.65625	16.6687	.90625	23.0187
.171875	4.3656	.421875	10.7150	.671875	17.0654	.921875	23.4150
.1875	4.7625	.4375	11.1125	.6875	17.4625	.9375	23.8125
.203125	5.1594	.453125	11.5094	.703125	17.8594	.953125	24.2094
.21875	5.5562	.46875	11.9062	.71875	18.2562	.96875	24.6062
.234375	5.9531	.484375	12.3031	.734375	18.6531	.984375	25.0031
.25	6.3500	.5	12.7000	.75	19.0500		

inches	mm	inches	mm	inches	mm	inches	mm
		.0025	.0635	.0050	.1270	.0075	.1905
.001	.0025	.0026	.0660	.0051	.1295	.0076	.1930
.002	.0051	.0027	.0686	.0052	.1321	.0077	.1956
.003	.0076	.0028	.0711	.0053	.1346	.0078	.1981
.004	.0102	.0029	.0737	.0054	.1372	.0079	.2007
.005	.0127	.0030	.0762	.0055	.1397	.0080	.2032
.006	.0152	.0031	.0787	.0056	.1422	.0081	.2057
.007	.0178	.0032	.0813	.0057	.1448	.0082	.2083
.008	.0203	.0033	.0838	.0058	.1473	.0083	.2108
.009	.0229	.0034	.0864	.0059	.1499	.0084	.2134
.010	.0254	.0035	.0890	.0060	.1524	.0085	.2150
.011	.0279	.0036	.0914	.0061	.1549	.0086	.2184
.012	.0305	.0037	.0940	.0062	.1575	.0087	.2210
.013	.0330	.0038	.0965	.0063	.1600	.0088	.2235
.014	.0356	.0039	.0991	.0064	.1626	.0089	.2261

inches	mm	inches	mm	inches	mm	inches	mm
.015	.0381	.0040	.1016	.0065	.1651	.0090	.2286
.016	.0406	.0041	.1041	.0066	.1676	.0091	.2311
.017	.0432	.0042	.1067	.0067	.1702	.0092	.2337
.018	.0457	.0043	.1092	.0068	.1727	.0093	.2362
.019	.0483	.0044	.1118	.0069	.1753	.0094	.2388
.020	.0508	.0045	.1143	.0070	.1778	.0095	.2413
.021	.0533	.0046	.1168	.0071	.1803	.0096	.2438
.022	.0559	.0047	.1194	.0072	.1829	.0097	.2464
.023	.0584	.0048	.1210	.0073	.1854	.0098	.2489
.024	.0610	.0049	.1245	.0074	.1880	.0099	.2515

inches	0	10	20	30	40	50	60	70	80	90
0	0	254.0	508.0	762.0	1016.0	1270.0	1524.0	1778.0	2032.0	2286.0
1	25.4	279.4	533.4	787.4	1041.4	1295.4	1549.4	1803.4	2057.4	2311.4
2	50.8	304.8	558.8	812.8	1066.8	1320.8	1574.8	1828.8	2082.8	2336.8
3	76.2	330.2	584.2	838.2	1092.2	1346.2	1600.2	1854.2	2108.2	2362.2
4	101.6	355.6	609.6	863.6	1117.6	1371.6	1625.6	1879.6	2133.6	2307.6
5	127.0	381.0	635.0	889.0	1143.0	1397.0	1651.0	1905.0	2159.0	2413.0
6	152.4	406.4	660.4	914.4	1168.4	1422.4	1676.4	1930.4	2184.4	2438.4
7	177.8	431.8	685.8	939.8	1193.8	1447.8	1701.8	1955.8	2209.8	2463.8
8	203.2	457.2	711.2	965.2	1219.2	1473.2	1727.2	1981.2	2235.2	2480.2
9	228.6	482.6	736.6	990.6	1244.6	1498.6	1752.6	2006.6	2260.6	2514.6

All sales are made on our STANDARD TERMS AND CONDITIONS OF SALE in effect at the time a customer's order is accepted. The current Terms and Conditions are set forth below:

STANDARD TERMS AND CONDITIONS OF SALE (February 2015)

These Terms and Conditions, the attendant quotation or acknowledgment and all documents incorporated by specific reference therein, will be the complete and exclusive statement of the terms of the agreement governing the sale of goods ("Goods") by Regal Beloit America Inc. and its divisions and subsidiaries ("Seller") to Customer ("Buyer"). Buyer's acceptance of the Goods will manifest Buyer's assent to these Terms and Conditions. If these Terms and Conditions differ in any way from the terms and conditions of Buyer's order, or other documentation, this document will be construed as a counteroffer and will not be deemed an acceptance of Buyer's terms and conditions which conflict herewith.

1. **PRICES:** Unless otherwise specified in writing by Seller, Seller's price for the goods shall remain in effect for thirty (30) days after the date of Seller's quotation or acknowledgment of Buyer's order for the Goods, whichever occurs first, provided an unconditional, complete authorization for the immediate shipment of the Goods is received and accepted by Seller within such time period. If such authorization is not received by Seller within such thirty (30) day period, Seller shall have the right to change the price for the Good to Seller's price for the Goods at the time of shipment.

2. **TAXES:** Any tax or governmental charge or increase in same hereafter becoming effective increasing the cost to Seller of producing, selling or delivering the Goods/provision of Services or of procuring material used therein, and any tax now in effect or increase in same payable by the Seller because of the manufacture, sale or delivery of the Goods/provision of Services, may at Seller's option, be added to the price.

3. **TERMS OF PAYMENT:** Subject to the approval of Seller's Credit Department, terms are net thirty (30) days from date of Seller's invoice in U.S. currency. If any payment owed to Seller is not paid when due, it shall bear interest, at a rate to be determined by Seller, which shall not exceed the maximum rate permitted by law, from the date on which it is due until it is paid. Seller shall have the right, among other remedies, either to terminate the Agreement or to suspend further performance under this and/or other agreements with Buyer in the event Buyer fails to make any payment when due. Buyer shall be liable for all expenses, including attorneys' fees, relating to the collection of past due amounts.

4. **SHIPMENT AND DELIVERY:** Shipments are made F.O.B. Seller's shipping point. Any claims for shortages or damages suffered in transit shall be submitted by the Buyer directly to the carrier. While Seller will use all reasonable commercial efforts to maintain the delivery date for the Goods or the date of provision of Services acknowledged or quoted by Seller, all such dates are approximate. Seller reserves the right to make partial shipments and to segregate "specials" and made-to-order Goods from normal stock Goods. Seller shall not be bound to tender delivery of any Goods for which Buyer has not provided shipping instructions.

5. **QUANTITY:** Buyer agrees to accept overruns of up to ten percent (10%) of the order on "made-to-order" Goods, including parts. Any such additional items shall be priced at the price per item charged for the specific quantity ordered.

6. **LIMITED WARRANTY:** Subject to the limitations of Section 7, Seller warrants that the Goods will be free from defects in material and workmanship under normal use, service and maintenance and Services will be performed by trained personnel using proper equipment and instrumentation for the particular Service provided. Any licensed firmware embodied in the Goods will execute the programming instructions provided by Seller. The foregoing warranties will apply until the expiration of the applicable warranty period. Except as specified below, Goods are warranted for twelve (12) months (unless otherwise specified by Seller in writing) from the date of shipment of the Goods by Seller. Consumables and Services (except as specified below) are warranted for a period of 90 days from the date of shipment or completion of the Services. Products purchased by Seller from a third party for

resale to Buyer ("Resale Products") shall carry only the warranty extended by the original manufacturer. Buyer agrees that Seller has no liability for Resale Products beyond making a reasonable commercial effort to arrange for procurement and shipping of the Resale Products. **THIS IS THE SOLE AND EXCLUSIVE WARRANTY GIVEN BY SELLER WITH RESPECT TO THE GOODS/SERVICES AND IS IN LIEU OF AND EXCLUDES ALL OTHER WARRANTIES, EXPRESS OR IMPLIED, ARISING BY OPERATION OF LAW OR OTHERWISE, INCLUDING WITHOUT LIMITATION, MERCHANTABILITY OR FITNESS FOR A PARTICULAR PURPOSE WHETHER OR NOT THE PURPOSE OR USE HAS BEEN DISCLOSED TO SELLER IN SPECIFICATIONS, DRAWINGS OR OTHERWISE, AND WHETHER OR NOT SELLER'S PRODUCTS ARE SPECIFICALLY DESIGNED AND/OR MANUFACTURED BY SELLER FOR BUYER'S USE OR PURPOSE.**

This warranty does not extend to any losses or damages due to misuse, accident, abuse, neglect, normal wear and tear, unauthorized modification or alteration, use beyond rated capacity, or improper installation, maintenance or application. To the extent that Buyer or its agents has supplied specifications, information, representation of operating conditions or other data to Seller in the selection or design of the Goods or provision of Services and the preparation of Seller's quotation, and in the event that actual operating conditions or other conditions differ from those represented by Buyer, any warranties or other provisions contained herein which are affected by such conditions shall be null and void. If within thirty (30) days after Buyer's discovery of any warranty defects within the warranty period, Buyer notifies Seller thereof in writing, Seller shall, at its option, repair, correct, or replace F.O.B. point of manufacture, or refund the purchase price for, that portion of the goods found by Seller to be defective. Failure by Buyer to give such written notice within the applicable time period shall be deemed an absolute and unconditional waiver of Buyer's claim for such defects. Goods repaired or replaced during the warranty period shall be covered by the foregoing warranty for the remainder of the original warranty period or ninety (90) days, whichever is longer. Buyer assumes all other responsibility for any loss, damage, or injury to persons or property arising out of, connected with, or resulting from the use of Goods, either alone or in combination with other products/components.

SECTIONS 6 AND 7 APPLY TO ANY ENTITY OR PERSON WHO MAY BUY, ACQUIRE OR USE SELLER'S GOODS, INCLUDING ANY ENTITY OR PERSON WHO BUYS THE GOODS FROM SELLER'S DISTRIBUTOR AND SUCH ENTITY OR PERSON SHALL BE BOUND BY THE LIMITATIONS THEREIN.

7. LIMITATION OF REMEDY AND LIABILITY: THE SOLE AND EXCLUSIVE REMEDY FOR BREACH OF ANY WARRANTY HEREUNDER (OTHER THAN THE WARRANTY PROVIDED UNDER SECTION 13) SHALL BE LIMITED TO REPAIR, CORRECTION, REPLACEMENT, OR REFUND OF THE PURCHASE PRICE UNDER SECTION 6. SELLER SHALL NOT BE LIABLE FOR DAMAGES CAUSED BY DELAY IN PERFORMANCE AND IN NO EVENT, REGARDLESS OF THE FORM OF THE CLAIM OR CAUSE OF

ACTION (WHETHER BASED IN CONTRACT, INFRINGEMENT, NEGLIGENCE, STRICT LIABILITY, OTHER TORT OR OTHERWISE), SHALL SELLER'S LIABILITY TO BUYER AND/OR ITS CUSTOMERS EXCEED THE PRICE TO BUYER OF THE SPECIFIC GOODS OR SERVICES PROVIDED BY SELLER GIVING RISE TO THE CLAIM OR CAUSE OF ACTION. BUYER AGREES THAT IN NO EVENT SHALL SELLER'S LIABILITY TO BUYER AND/OR ITS CUSTOMERS EXTEND TO INCLUDE INCIDENTAL, CONSEQUENTIAL OR PUNITIVE DAMAGES. THE TERM "CONSEQUENTIAL DAMAGES" SHALL INCLUDE, BUT NOT BE LIMITED TO, LOSS OF ANTICIPATED PROFITS, LOSS OF USE, LOSS OF REVENUE, COST OF CAPITAL AND DAMAGE OR LOSS OF OTHER PROPERTY OR EQUIPMENT AND COSTS INCURRED INCLUDING WITHOUT LIMITATION FOR CAPITAL, FUEL AND POWER, AND CLAIMS OF BUYER'S CUSTOMERS. GOODS AND/OR SERVICES SOLD HEREUNDER ARE NOT FOR USE IN ANY NUCLEAR AND RELATED APPLICATIONS.

Buyer accepts goods and/or services with the foregoing understanding, agrees to communicate the same in writing to any subsequent purchaser or users and to defend, indemnify and hold harmless Seller from any claims, losses, suits, judgments and damages, including incidental and consequential damages, arising from such use, whether the cause of action be based in tort, contract or otherwise, including allegations that the Seller's liability is based on negligence or strict liability.

8. **BUYER RESPONSIBILITIES:** Buyer shall provide Seller ready access to the site where services are to be performed and adequate workspace and facilities to perform same as provided in these terms and conditions. Buyer shall not require Seller or its employees, as a condition to site access or otherwise, to further agree or enter into any agreement, which waives, releases, indemnifies or otherwise limits or expands any rights or obligations whatsoever. Any such agreements shall be null and void. Buyer shall inform Seller, in writing, at the time of order placement, of any known hazardous substance or condition at the site, including, but not limited to, the presence of asbestos or asbestos containing materials, and shall provide Seller with any applicable Material Data Safety Sheets regarding same. Buyer shall appoint a representative familiar with the site and the nature of the services to be performed by Seller to be present at all times that Seller personnel are at the site. Seller shall not be liable for any expenses incurred by Buyer in removing, replacing or refurbishing any Buyer equipment or any part of Buyer's building structure that restricts Seller access. Buyer personnel shall cooperate with and provide all necessary assistance to Seller. Seller shall not be liable or responsible for any work performed by Buyer.

9. **BUYER SUPPLIED DATA:** To the extent that Seller has relied upon any data or information supplied by Buyer to Seller ("Data") in the selection or design of the Goods and/or provision of the Services and the preparation of Seller's quotation, and the Data is inadequate or inaccurate, any warranties or other provisions contained herein which are affected by such conditions shall be null and void.

10. **TECHNICAL ADVICE:** It is expressly understood that the Seller assumes no obligation or liability for any technical advice given without charge and furnished by the Seller with respect to the use of the Goods. All such technical advice, or results obtained, is given and accepted at Buyer's risk.

11. **EXCUSE OF PERFORMANCE:** Seller shall not be liable for delays in performance or for nonperformance due to acts of God, acts of Buyer, war, riot, fire, flood, other severe weather, sabotage, or epidemics; strikes or labor disturbances; governmental requests, restrictions, laws, regulations, orders or actions; unavailability of or delays in transportation; default of suppliers; or unforeseen circumstances or any events or causes beyond Seller's reasonable control. Deliveries of Goods or provision of Services may be suspended for an appropriate period of time as a result of the foregoing. If Seller determines that its ability to supply the total demand for the Goods, or to obtain material used

directly or indirectly in the manufacture of the Goods, is hindered, limited or made impracticable due to causes addressed in this Section 8, Seller may allocate its available supply of the Goods or such material (without obligation to acquire other supplies of any such Goods or material) among itself and its purchasers on such basis as Seller determines to be equitable without liability for any failure of performance which may result there from. Deliveries suspended or not made by reason of this section may be canceled by Seller upon notice to Buyer without liability, but the balance of the agreement shall otherwise remain unaffected.

12. **CANCELLATIONS AND DELAYS:** The Buyer may cancel orders only upon written notice and upon payment to Seller of cancellation charges which include, among other things, all costs and expenses incurred and commitments made by the Seller and a reasonable profit thereon. Any request by Buyer to extend the delivery schedule must be agreed to in writing by the Seller. If agreement cannot be reached, Seller may deliver product or provide services to the last known ship to address and invoice the Buyer upon completion of the product or services or prior delivery date, whichever is later.

13. **CHANGES:** Buyer may request changes or additions to the Goods/Services consistent with Seller's specifications and criteria. In the event such changes or additions are accepted by Seller, Seller may revise the price and delivery schedule. Seller reserves the right to change designs and specifications for the Goods or Services without prior notice to Buyer, except with respect to Goods being made-to-order for Buyer. Seller may cancel any order or terminate any agreement without liability to Buyer if Buyer fails to meet the conditions specified herein.

14. **TOOLING:** Tool, die, and pattern charges, if any, are in addition to the price of the Goods/Services and are due and payable upon completion of the tooling. All such tools, dies and patterns shall be and remain the property of Seller. Charges for tools, dies, and patterns do not convey to Buyer, title, ownership interests in, or rights to possession or removal, nor prevent their use by Seller for other purchasers, except as otherwise expressly provided by Seller and Buyer in writing with reference to this provision.

15. **SOFTWARE AND FIRMWARE:** Notwithstanding any other provision herein to the contrary, Seller or applicable third party owner shall retain all rights of ownership and title in its respective firmware and software, including all copyrights relating to such firmware and software and all copies of such firmware and software. Except as otherwise provided herein, Buyer is hereby granted a nonexclusive, royalty free license to use firmware and software, and copies of firmware and software, incorporated into the Goods only in conjunction with such Goods and only at the Buyer's plant site where the Goods are first used. Buyer's use of certain firmware (as specified by Seller) and all other software shall be governed exclusively by Seller's and/or third party owner's applicable license terms.

16. **ASSIGNMENT:** Buyer shall not assign its rights or delegate its duties hereunder or any interest therein or any rights hereunder without the prior written consent of the Seller, and any such assignment, without such consent, shall be void.

17. **PATENTS AND COPYRIGHTS:** Subject to Section 7, Seller warrants that the Goods and/or Services sold, except as are made specifically for Buyer according to Buyer's specifications, do not infringe any valid U.S. patent or copyright in existence as of the date of delivery. This warranty is given upon the condition that Buyer promptly notify Seller of any claim or suit involving Buyer in which such infringement is alleged, and, that Buyer cooperate fully with Seller and permit Seller to control completely the defense or compromise of any such allegation of infringement. Seller's warranty as to use only applies to infringements arising solely out of the inherent operation (i) of such Goods, or (ii) of any combination of Goods in a system designed by Seller. In the event such Goods and/or Services, singularly or in combination, are held to infringe a U.S. patent or copyright in such suit, and the use of such Goods and/or Services is enjoined, or in the case of a compromise by Seller, Seller shall have the

right, at its option and expense, to procure for Buyer the right to continue using such Goods or providing such Services, or replace them with non-infringing Goods or Services; or modify same to become non-infringing; or grant Buyer a credit for the depreciated value of such Goods and accept return of them or grant Buyer a credit for such provided Services.

18. EXPORT/IMPORT: Buyer agrees that all applicable import and export control laws, regulations, orders, and requirements, including without limitation those of the United States and the European Union, and the jurisdictions in which the Seller and the Buyer are established or from which Goods may be supplied, will apply to their receipt and use. In no event shall Buyer use, transfer, release, import, or export Goods in violation of such applicable laws, regulations, orders or requirements.

19. HIRING/EMPLOYEES: Buyer agrees that during the execution of Services by Seller and for a period of twelve (12) months after the performance of Services, it will not hire any employee(s) of Seller and will not entice or counsel any such employee(s) to leave Seller's employ. Buyer agrees that this covenant shall extend to its agents and affiliates. In the event that an employee of Seller is hired or leaves the employ of Seller in such circumstances, Buyer shall pay Seller, as compensation for the cost incurred by Seller in recruiting and training the employee, the sum equivalent to six (6) months pay for each employee hired from or leaving the employment of Seller.

20. EMPLOYEE SAFETY AND SUSPENSION OF SERVICES: Seller may suspend or terminate Services, at its sole discretion, without liability to Buyer if Buyer fails to meet its obligations hereunder or becomes bankrupt or insolvent or if Seller determines that continuing to provide Services represents a hazardous condition for its employees.

21. MISCELLANEOUS: These terms and conditions set forth the entire understanding and agreement between Seller and Buyer, and supersede all other communications, negotiations and prior oral or written statements regarding the subject matter of these terms and conditions. No change, modification, rescission, discharge, abandonment, or waiver of these terms and conditions of Sale shall be binding upon the Seller unless made in writing and signed on its behalf by an officer of the Seller. No conditions, usage or trade, course of dealing or performance, understanding or agreement purporting to modify, vary, explain, or supplement these Terms and Conditions shall be binding unless hereafter made in writing and signed by the party to be bound, and no modification shall be affected by the acceptance of purchase orders or shipping instruction forms containing terms at variance with or in addition to those set forth herein. Any such modifications or additional terms are specifically rejected by Seller. No waiver by Seller with respect to any breach or default or any right or remedy and no course of dealing, shall be deemed to constitute a continuing waiver of any other breach or default or of any other right or remedy, unless such waiver be expressed in writing and signed by the party to be bound. Seller is not responsible for typographical or clerical errors made in any quotation, orders or publications. All such errors are subject to correction. The validity, performance, and all other matters relating to the interpretation and effect of this contract shall be governed by the law of the state of New York. The United Nations Convention on the International Sale of Goods shall not apply to any transaction hereunder.

ROLLWAY®

Regal Power Transmission Solutions
7120 New Buffington Rd
Florence, KY 41042
Customer Service: 800-626-2120
Fax: 800-262-3292
Technical Service: 800-626-2093

www.RegalPTS.com/Rollway

APPLICATION CONSIDERATIONS

The proper selection and application of power transmission products and components, including the related area of product safety, is the responsibility of the customer. Operating and performance requirements and potential associated issues will vary appreciably depending upon the use and application of such products and components. The scope of the technical and application information included in this publication is necessarily limited. Unusual operating environments and conditions, lubrication requirements, loading supports, and other factors can materially affect the application and operating results of the products and components and the customer should carefully review its requirements. Any technical advice or review furnished by Regal Beloit America, Inc. and its affiliates with respect to the use of products and components is given in good faith and without charge, and Regal assumes no obligation or liability for the advice given, or results obtained, all such advice and review being given and accepted at customer's risk.

For a copy of our Standard Terms and Conditions of Sale, Disclaimers of Warranty, Limitation of Liability and Remedy, please contact Customer Service at 1-800-626-2120. These terms and conditions of sale, disclaimers and limitations of liability apply to any person who may buy, acquire or use a Regal Beloit America Inc. product referred to herein, including any person who buys from a licensed distributor of these branded products.

Rollway is a trademark of Regal Beloit Corporation or one of its affiliated companies.

©2015 Regal Beloit Corporation, All Rights Reserved.
MCC15004E • Form# 9728E • Printed in USA

A Regal Brand



REGAL

www.regalbeloit.com